

OUTDOOR CAMPFIRE KIT

OCBE-44(P)

FOR OUTDOOR USE ONLY



OWNER'S MANUAL

Important: Read this manual carefully before installing this outdoor campfire kit.

FOR YOUR SAFETY IF YOU SMELL GAS:

1. Shut off the gas to the appliance.
2. Extinguish any open flame.
3. If odor continues, immediately call your gas supplier or the fire department.

FOR YOUR SAFETY

1. Do not store or use gasoline or other flammable vapors and liquids in the vicinity of this or any other appliance.
2. A propane cylinder not connected for use shall not be stored in the vicinity of this or any other appliance.

Installation and service must be performed by an NFI Certified or other qualified professional installer, service agency, or the gas supplier.

CODE AND SUPPLY REQUIREMENTS:

This outdoor campfire kit must be installed in accordance with local codes and ordinances, or, in the absence of local codes, with the latest *National Fuel Gas Code, ANSI Z223.1*.

⚠ WARNING

Improper installation, adjustment, alteration, service, or maintenance can cause injury or property damage. Refer to this manual. For assistance or additional information, consult a qualified professional installer, service agency, or the gas supplier.

This appliance is designed as an “**attended appliance.**” Adults **must** be present when the unit is operating. **DO NOT** leave this unit burning when unattended. If this product is left burning unattended, it may cause damage or serious injury.

INSTALLER & CONSUMER:

These instructions **MUST** be retained with this appliance



We recommend that our gas hearth products be installed and serviced by professionals who are certified in the U.S. by the National Fireplace Institute® (NFI) as NFI Gas Specialists.

TABLE OF CONTENTS

IMPORTANT SAFETY INFORMATION	2
PRE-INSTALLATION AND OUTDOOR CAMPFIRE PREPARATION SAFETY GUIDELINES	3
INSTALLATION SAFETY GUIDELINES	4
SAFETY GUIDELINES	4
SAFE USE & MAINTENANCE OF PROPANE-GAS CYLINDERS	5
PARTS LIST	6
MANUAL SYSTEM INSTALLATION SPECIFICATIONS	6
MANUAL SYSTEM INSTALLATION STEPS	7
PARTS LISTS AND SETUP INSTRUCTIONS	8
CAMPFIRE LOGS OPTION - PARTS LIST	8
CAMPFIRE LOGS OPTION - LAVA CHUNK PLACEMENT	9
CAMPFIRE LOGS OPTION - LOG PLACEMENT	9
BEACHWOOD LOGS AND/OR VOLCANIC STONE OPTION - PARTS LIST	10
BEACHWOOD/VOLCANIC STONE OPTION - SETUP	10
CHUNK AND STONE PLACEMENT	10
BEACHWOOD OPTION - SETUP	11
LOG PLACEMENT OPTION TWO - LOG SQUARE	11
LOG PLACEMENT OPTION THREE - LOG "TEEPEE"	11
GLASS OR RIVER ROCK ON GLASS OPTION - PARTS LIST	12
GLASS OR RIVER ROCK ON GLASS OPTION - LAVA CHUNK PLACEMENT	12
GLASS OR RIVER ROCK ON GLASS OPTION - GLASS PLACEMENT	12
GLASS OR RIVER ROCK ON GLASS OPTION - RIVER STONE PLACEMENT	12
IMPORTANT OPERATIONAL SAFETY INFORMATION	13
REPLACING BATTERIES	13
OPERATING THE MANUAL OUTDOOR CAMPFIRE	14
MANUAL UNIT LIGHTING INSTRUCTIONS	14
CONVERTING YOUR CAMPFIRE TO A DIFFERENT GAS TYPE	15
PETERSON OUTDOOR CAMPFIRE LIMITED WARRANTY	16

IMPORTANT SAFETY INFORMATION

BE CAREFUL

If not installed and used correctly per these instructions, this product can cause serious injury.

CAUTION: Installation and repair must be done by an NFI Certified or other qualified professional installer. Read these instructions before installing this outdoor campfire kit. Be sure you understand all safety precautions and warnings contained in this manual.

- A.** For outdoor use only. This unit must be installed at least 36" from any combustible walls or material. IT MUST NOT BE INSTALLED UNDER ANY TYPE OF CEILING OR OVERHANG.
- B. WARNING:** CARBON MONOXIDE POISONING MAY LEAD TO DEATH. DO NOT MODIFY THIS OUTDOOR CAMPFIRE OR ITS CONTROLS, EXCEPT AS PROVIDED FOR IN THIS MANUAL. Any other change may be dangerous. Improper installation or use of the outdoor campfire kit can cause serious injury or death from fire, burns, explosions, or carbon monoxide poisoning.
- C.** Check state and local codes to determine if the outdoor campfire kit is permitted in your locality before installation.

The manual valve allows adjustable flame height and heat output. THESE SETTINGS MUST ALWAYS BE HIGH ENOUGH FOR THE FLAME TO BE CLEARLY VISIBLE.

PRE-INSTALLATION AND OUTDOOR CAMPFIRE KIT PREPARATION SAFETY GUIDELINES

- A.** Before installing this outdoor campfire kit, check **MINIMUM CLEARANCE TO COMBUSTIBLES** to ensure that the surrounding area is **properly sized for the installation**. **MINIMUM CLEARANCES** must be maintained when you install this outdoor campfire kit. **ALL SIDES** of the enclosure opening **MUST BE AT LEAST 36"** from any combustible side walls. The unit **MUST NOT BE** installed under any type of ceiling or overhang.
- B.** The outdoor campfire kit is for outdoor use only. **DO NOT** install or use this appliance inside a building, garage, or any other enclosed area, including recreational vehicles and/or boats. **This unit must be installed in such a manner that the vent screens at the base of the unit remain clear and free of all obstructions at all times and during all weather conditions.**
- C. CHECK GAS TYPE** (natural gas or propane): The gas supply you intend to use may not be the same as that stated on the outdoor campfire kit rating plate as purchased. If the gas supply is different, **convert the outdoor campfire kit to the gas type you intend to use**. See instructions on p. 15. If you are unsure, contact the dealer for assistance.
- D. FOR NATURAL GAS:** The minimum inlet gas-supply pressure for purposes of input adjustment is **5"** water column (w.c.), and the maximum inlet gas-supply pressure is **10.5 "** w.c. **FOR PROPANE:** The minimum inlet gas-supply pressure for purposes of input adjustment is **10"** w.c., and the maximum inlet gas-supply pressure is **13"** w.c.
- E. DO NOT INSTALL THIS UNIT IF MINIMUM PRESSURE IS NOT AVAILABLE OR IF MAXIMUM PRESSURE IS EXCEEDED (SEE D., ABOVE).**
- F.** Gas piping system must be sized to provide minimum inlet pressure at the maximum flow rate (BTU/hr). Undue pressure loss will occur if the pipe is too small, or the run is too long.
- G.** For installations at elevations above 2,000 ft., contact your local dealer or gas supplier before installing, as input ratings should be reduced approximately 4% for each 1,000 ft. above sea level. Refer to the National Fuel Gas Code.
- H.** This gas appliance and its main gas valve must be disconnected from the gas-supply piping system during any pressure testing of that system at test pressures in excess of 1/2 psig. This is accomplished by closing the gas-supply line valve. This gas appliance must be isolated from the gas-supply piping system by closing its equipment shutoff valve during any pressure testing of the gas-supply piping system at test pressures equal to or less than 1/2 psig.
- I. INSTALLER NOTE:** This unit should be installed so that it can be removed at a later date if factory service is required. Any protrusion into the outdoor campfire enclosure may obstruct the frame and prevent the unit from being removed (see GAS-SUPPLY PLUMBING REQUIREMENTS, below).
- J. GAS-SUPPLY PLUMBING REQUIREMENTS**
- Apply only joint compounds that are resistant to all gasses on all male pipe fittings. Make sure to tighten every joint securely. Do not use pipe joint compound to connect flare fittings. Bring the gas-supply pipe up from beneath the enclosure near its center. If it is not possible to stub the gas line in from the center of the enclosure, the connection may be made through the side of the enclosure.

Note: An external on/off valve in the gas line is required for safety when the outdoor campfire is not in use. It also provides for convenient maintenance and repair.

INSTALLATION SAFETY GUIDELINES

- A. Carefully inspect the burner and log cartons for shipping damage. If any parts are damaged, call the dealer.
- B. Correct installation and proper placement of the burner assembly, Lava Chunks, and other decorative options are crucial to the safe performance of the outdoor campfire kit. See installation instructions for further information. **NEVER DIRECTLY COVER THE BURNER SCREEN WITH LAVA CHUNKS, APPROVED DECORATIVE MEDIA OR ANY OTHER ITEM. THIS WILL IMPAIR ITS EFFICIENCY AND CAUSE THE UNIT TO MALFUNCTION.**
- C. Ensure that the unit is installed in such a manner that the required vent openings remain obstacle-free at all times and during all weather conditions.
- D. Due to high temperatures, the outdoor campfire must be located out of traffic areas and away from combustibles.

SAFETY GUIDELINES

- A. When shutting the unit down—be sure to TURN THE CONTROL VALVE FULLY OFF.
- B. **DO NOT** sit or place any part of the body or combustible materials on or near the outdoor campfire surround or burner area. Children and adults should be alerted to the hazard of high surface temperatures and should stay away to avoid burns or ignition of clothing.
- C. Every time you use the outdoor campfire, make sure that:
 - 1. The area around the outdoor campfire is clear of flammable substances such as gasoline, yard debris, wood, etc.
 - 2. **THE SCREEN IS NOT DIRECTLY COVERED OR BLOCKED WITH LAVA CHUNKS OR ANY OTHER ITEM.**
 - 3. There is no blockage of the airflow through the side air vents (see Fig. 6-3).
- D. **WARNING: HOT WHILE IN OPERATION AND FOLLOWING OPERATION.** Serious injury can occur! **DO NOT** throw trash, paper, or other flammable materials onto the outdoor campfire. **DO NOT** leave in operation when unattended.
WARNING: DO NOT operate this outdoor campfire in the rain.
- E. SOLID FUEL MUST NOT BE BURNED in the outdoor campfire.
- F. **DO NOT** continue using if you smell unusual odors, or have headaches, nausea, or dizziness.
- G. **DO NOT** store any combustible materials, gasoline, and any other flammable vapors/liquids in the vicinity of the outdoor campfire. Provide adequate clearance for servicing and operation.
- H. **DO NOT** place clothing or any flammable material on or near the outdoor campfire. Matches, paper, garbage, or any other material must not be thrown on top of the decorative media, burner, or into the flame.
- I. **DO NOT** use the outdoor campfire if any part of it has been underwater. Immediately call a qualified professional service technician to inspect the outdoor campfire and to replace any part of the control system that has been underwater.

SAFE USE & MAINTENANCE OF PROPANE-GAS CYLINDERS

IMPORTANT FOR YOUR SAFETY

READ AND FOLLOW ALL WARNINGS PROVIDED WITH THE PROPANE-GAS CYLINDER.

When operating this appliance with a propane-gas cylinder, these instructions and warnings **MUST** be observed.

FAILURE TO DO SO MAY RESULT IN A SERIOUS FIRE OR EXPLOSION.

CYLINDER/CONNECTOR REQUIREMENTS

- Propane-gas cylinders, valves, and hoses must be maintained in good condition and must be replaced if there is visible damage to either the cylinder or valve. If the hose is cut or shows excessive abrasion or wear, it must be replaced before using the gas appliance (see e.).
- This unit, when used with a cylinder, should be connected to a standard 5-gallon (20 lb.) propane-gas cylinder equipped with an OPD (Overfill Prevention Device). The OPD has been required on all cylinders sold since October 1, 1998, to prevent overfilling.
- Cylinder dimensions should be approximately 12" (30.5 cm) in diameter and 18" (45.7 cm) high. Cylinders must be constructed and marked in accordance with the *Specifications for Propane-Gas Cylinders of the U.S. Department of Transportation (D.O.T.)* or the National Standard of Canada, *CAN/CSA-B339, Cylinders, Spheres, and Tubes for Transportation of Dangerous Goods*.
- The cylinder must include a collar to protect the cylinder valve, and the cylinder supply system must be arranged for vapor withdrawal.
- The pressure regulator and hose assembly used must match the specification for Type I by *ANSI Z 21.58-2005/CGA 1.6-2005* (see Fig. 5-1).
- The propane-gas cylinder valve must be equipped with a cylinder connection coupling device, described as Type I in the standard defined in paragraph e. above. This device is commonly described as an Acme thread quick coupler.
- If the propane-gas cylinder comes with a dust plug, place the dust cap on the cylinder valve outlet whenever the cylinder is not in use.

QUICK COUPLER OPERATION

To connect the regulator/hose assembly to the propane-gas cylinder valve fitting: Press the hand nut on the regulator over the Acme thread fitting on the cylinder valve. Turn the hand nut clockwise to engage the threads and tighten until snug. The use of pliers or a wrench should not be necessary. Only cylinders marked "propane" may be used.

To disconnect: Turn the hand nut counterclockwise until detached (Fig. 5-1).

Important: Before using the unit, and after each time the cylinder is removed and reattached, check the hose for wear (see a.) and check all connections for leaks. Turn off the unit valves and open the main cylinder valve, then check connections with soapy water. Repair any leaks before lighting the unit.

CAUTION: Always turn the propane cylinder main valve off after each use, and before moving the unit and cylinder, or disconnecting the coupling. This valve must remain closed and the cylinder disconnected while the appliance is not in use, even though the gas flow is stopped by a safety feature when the coupler is disconnected.

Carefully inspect the hose assembly each time before the gas is turned on. A cracked or frayed hose should be replaced immediately.

If the appliance is stored indoors, the cylinder must be disconnected and removed. **Cylinders must be stored out of doors, out of the reach of children,** and must not be stored in a building, garage, or any other enclosed area.

FOR YOUR SAFETY

- DO NOT store a spare propane-gas cylinder under or near this appliance.
- NEVER fill the cylinder beyond 80-percent full.
- IF THE INFORMATION IN a. AND b. IS NOT FOLLOWED EXACTLY, A FIRE CAUSING DEATH OR SERIOUS INJURY MAY OCCUR.

Fig. 5-1 Type I Acme thread quick coupler

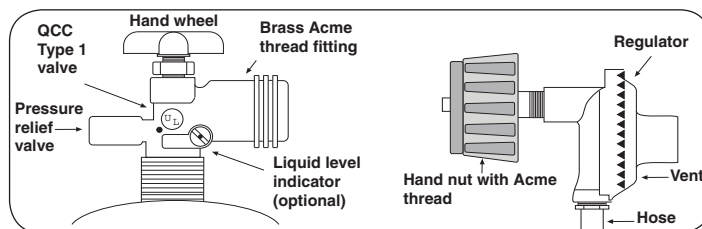

PROPANE CYLINDER ENCLOSURES

FOR YOUR SAFETY, you must provide the openings listed below for drainage, replacement air, and cross-ventilation of any storage area exposed to possible leakage from gas connections, the unit, or propane cylinders:

One side of the gas cylinder enclosure left completely open to the outside **OR** by providing four (4) ventilation openings. Two (2) openings are to be at the cylinder valve level (approx. 16" [40.6 cm] above the floor) and on opposite walls of the enclosure. Two more openings must be at the floor level on opposite sides of the enclosure. The floor-level openings must start at the floor and shall extend no higher than 5" (12.7 cm) above the floor. Each opening must have a minimum of 10 sq. in. (64.5 cm²) of free area. To achieve the proper ventilation, you may drill a series of holes, omit the grout from masonry joints, or replace a brick with a hardware cloth screen. If the floor in the cabinet is raised and the space beneath the cabinet is open to the outside, the lower ventilation openings may be located in the floor.

Consult your gas supplier for ventilation and regulator requirements when connecting to a household propane supply.

OCBE-44(P) Manual Valve

Item

- 1. Electronic control panel assy. (1)
- 2. Burner pan assembly (1)

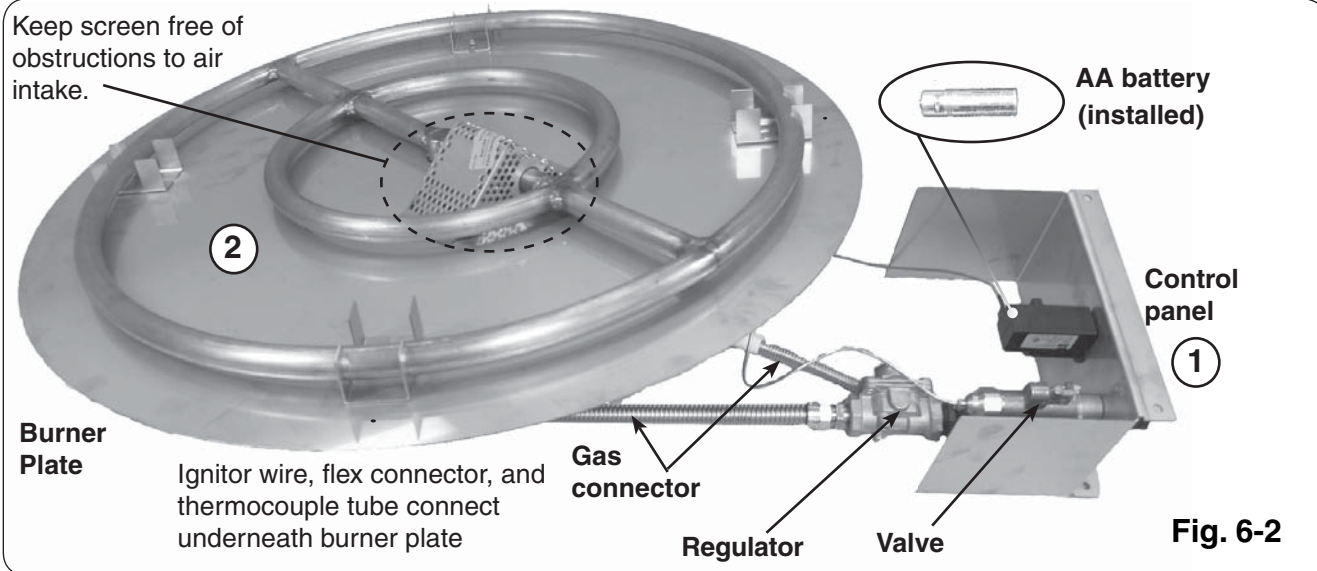
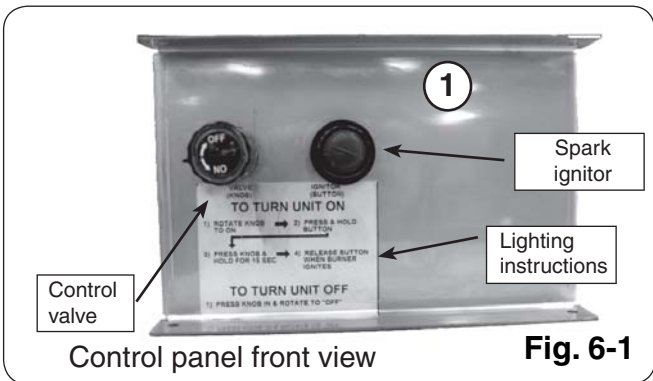

MANUAL SYSTEM INSTALLATION SPECIFICATIONS

When installing in your enclosure, allow a minimum of 8" (vertical) from the bottom of the control system to the burner pan (Fig. 6-1). This will allow adequate access for maintenance and troubleshooting.

Note: A minimum of two openings (10 sq. in. minimum each) must be provided for adequate combustion air (see Fig. 6-1).

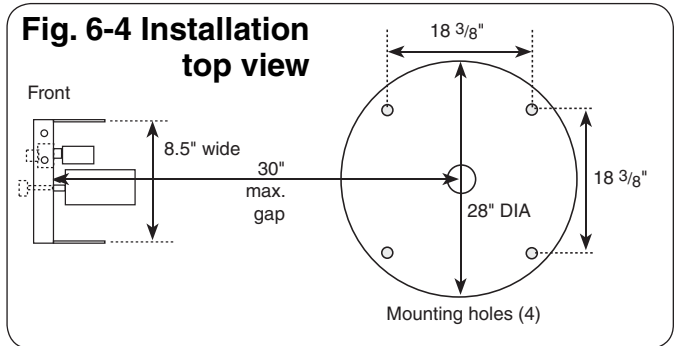
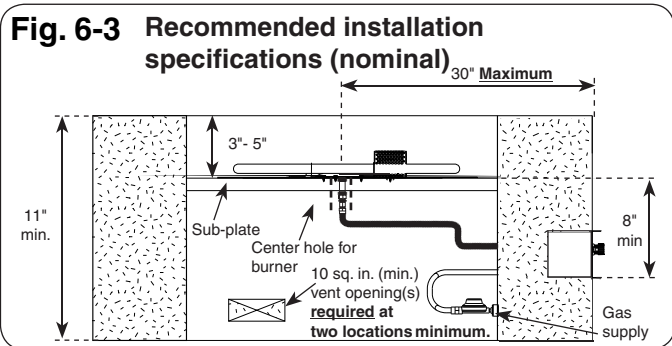

Important: When designing and/or constructing your fire ring, it is important to use the dimensions in this manual to ensure adequate and correct sizing for fitting the outdoor campfire kit control system and burner pan. It is also important to leave adequate access for installation, and for maintenance of this unit when installed in your fire pit or enclosure. Reference the relevant INSTALLATION SPECIFICATIONS section for dimensions and recommendations.

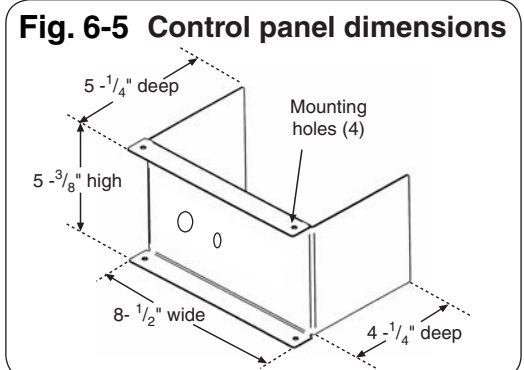

MANUAL SYSTEM INSTALLATION STEPS

CAUTION: Installation and repair must be done by an NFI Certified or other qualified professional installer. Installer: Carefully read these instructions before installing this product. Be sure you understand all safety precautions and warnings contained in this manual.

1. Check the parts you received against the parts list.
2. Secure the burner pan (burner upward) into the top of your fire ring with the four (4) mounting holes on the burner pan (Fig. 7-2) using suitable screws, depending on material used for your enclosure. Do not overtighten.
3. Secure the control panel into the recess in the side of your fire enclosure with the four (4) mounting holes (2 top, 2 bottom; Fig. 7-1), using suitable screws, depending on the material used for your enclosure.

- Note:** Flex connectors, thermocouple tube, and ignitor wires come pre-connected from the factory except for one end of the gas-supply flex connector (B). If any connections must be temporarily removed for installation purposes or they become accidentally disconnected during installation, mark them as they were shipped for later reconnection. This is shown in Fig. 7-1 and Fig. 7-2.
4. Connect the open end of flex connector B to your gas-supply line, and tighten all connections. Turn on the gas supply, ignite the burner, and test at all connections for leaks using a half-and-half soap and water solution. If bubbles appear, a leak is present. Turn off the gas and tighten at all connections. Repeat until no leaks are present.

NEVER USE A FLAME TO CHECK FOR LEAKS.

CAUTION: Adequate ventilation must be maintained above and below the burner pan when operating your outdoor campfire.

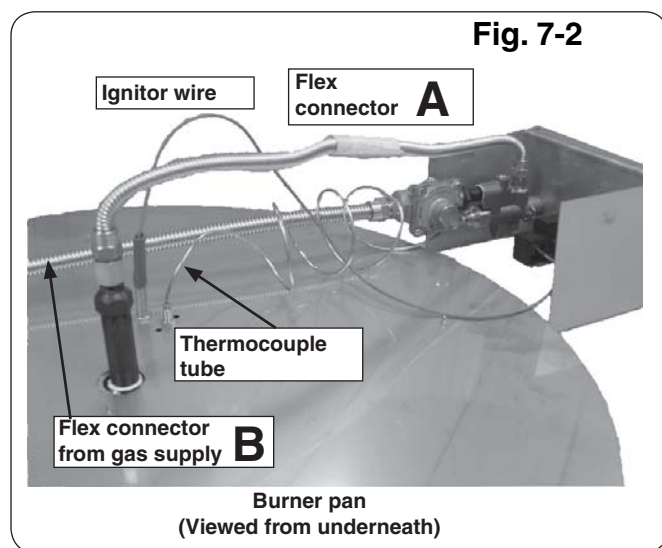
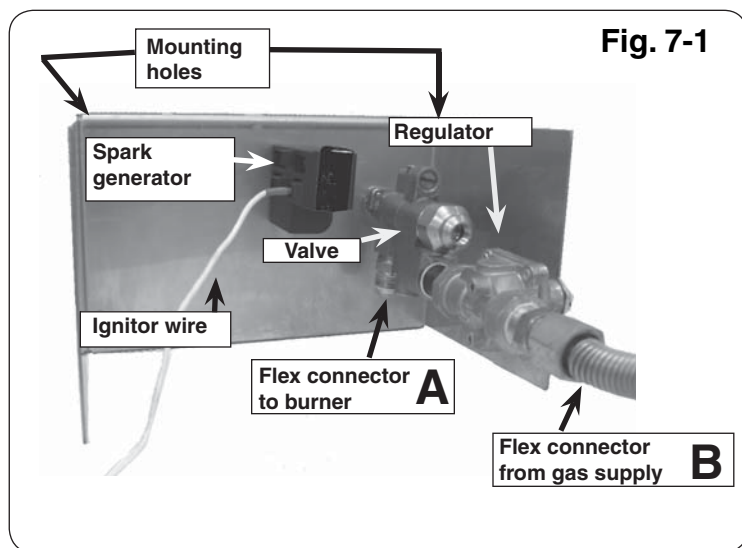

PARTS LISTS AND SETUP INSTRUCTIONS

OUTDOOR CAMPFIRE KIT DECORATIVE OPTIONS

The OCBE-44 outdoor campfire kit has several options for decorative media, each with a different set of components and setup instructions. These setup instructions are your reference. None of these options come with the OCBE-44 kit unless ordered separately.

Note: Lava Chunks are always placed on the burner first in each option. This provides an important base for the diffusion of gas and air. Depending on fire-pit size, more Lava Chunks than ship with a standard decorative media option may be required.

IMPORTANT: This gas burner must be surrounded by a medium comparable to the Lava Chunks shown in the following options to work safely and as designed.

CAMPFIRE LOGS OPTION - PARTS LIST

CARTON 1: (OCL-34)

#	Description	Qty	#	Description	Qty
1.	"Y" center support log	1	7.	Wood chips (6 pcs.)	1
2.	Curved bottom log	2	8.	Lava Chunks (8 lbs.)	2
3.	12" top log w/knothole	1			
4.	13" top log w/knothole	1			
5.	12" top log	2			
6.	8" top log	4			

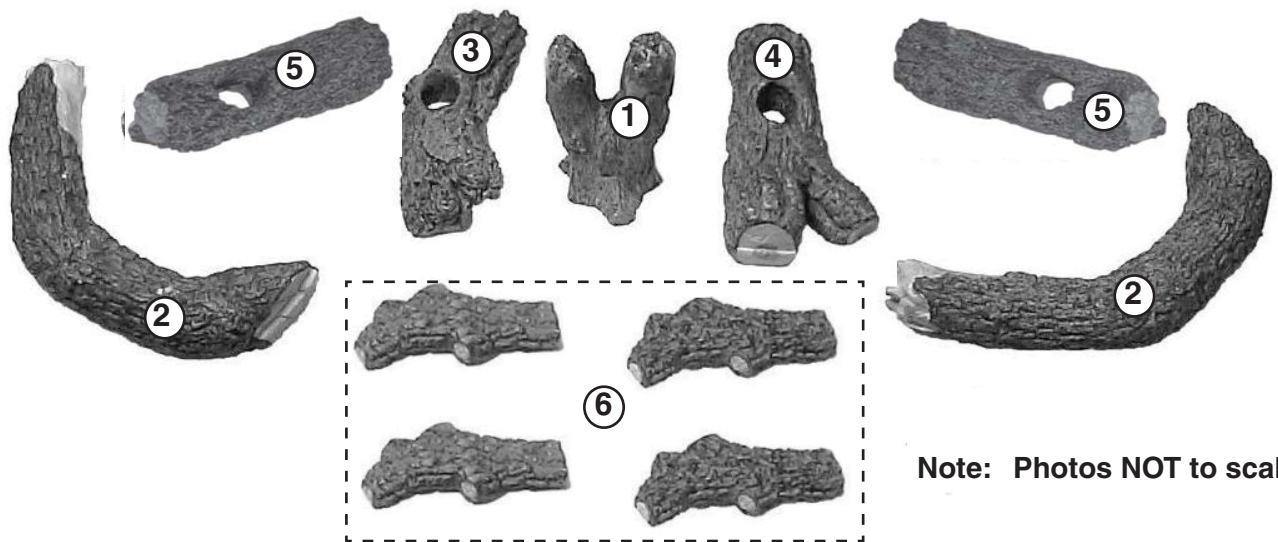

Note: Photos NOT to scale.



CAMPFIRE LOGS OPTION - LAVA CHUNK PLACEMENT

WARNING

This screen must be clear and free of obstructions at all times to ensure proper operation (Fig. 9-1).

LAVA CHUNK PLACEMENT

1. Pour the two (2) bags of Lava Chunks (PARTS LIST, Item #8) into the outdoor campfire, evenly covering the burner pan assembly with the exception of the screen.

CAUTION: DO NOT COVER THE SCREEN.

Screen with Lava Chunks on burner pan

**DO NOT PLACE
LAVA CHUNKS
ON THE SCREEN**

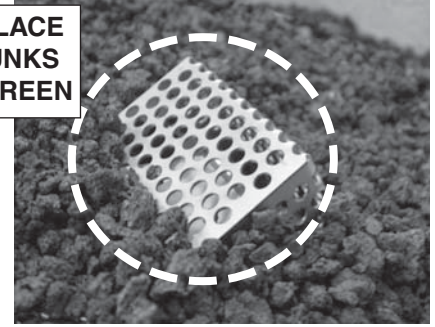
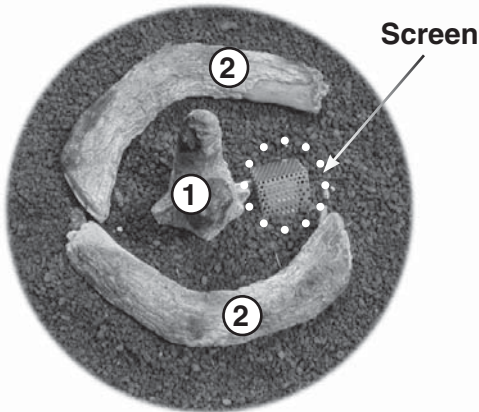

Fig. 9-1

CAMPFIRE LOGS OPTION - LOG PLACEMENT

1. Place the Y-shaped support log (Log #1) on the lava in the center of the enclosure (Fig. 9-2).

Fig. 9-2, Steps 1 & 2



CAUTION: THE CAMPFIRE OR DECORATIVE MEDIA WILL REMAIN HOT FOR SOME TIME AFTER USE. IF YOU NEED TO REPOSITION ANY DECORATIVE MEDIA, USE HEAT-RESISTANT GLOVES OR ALLOW TO COOL BEFORE HANDLING.

2. Place the two curved bottom logs (Logs #2) on opposite sides of the support log so as to keep the screen clear (Log #1).
3. Rest the two (2) knothole top logs (Log #3, Log #4) against the center support log with one end in the lava.
4. Rest the next two top logs (Logs #5) against the support log with the other ends resting in the lava, forming a teepee-type stack (Fig. 9-3).

Fig. 9-3, Steps 3 & 4

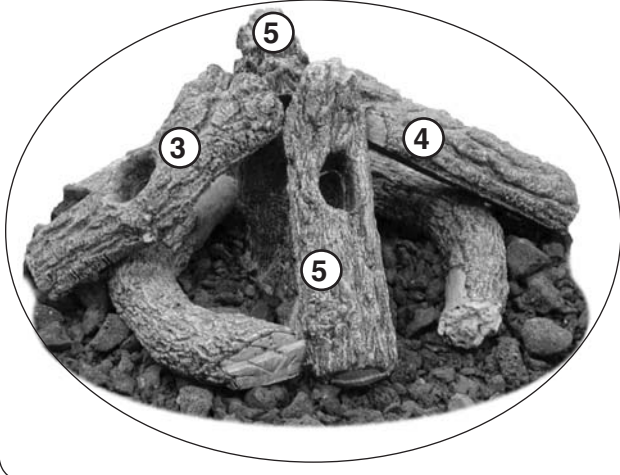

The finished
log stack

Fig. 9-4, Steps 5 & 6

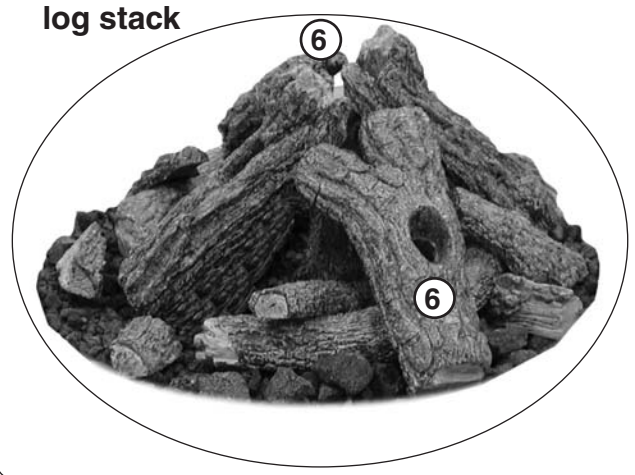

5. Place the four (4) smallest logs (PARTS LIST, Item #6) so they rest on the curved bottom logs as desired.
6. Place the six (6) wood chips (PARTS LIST, Item #7) as desired around the log stack (Fig. 9-4).

BEACHWOOD LOGS AND/OR VOLCANIC STONE OPTION - PARTS LIST

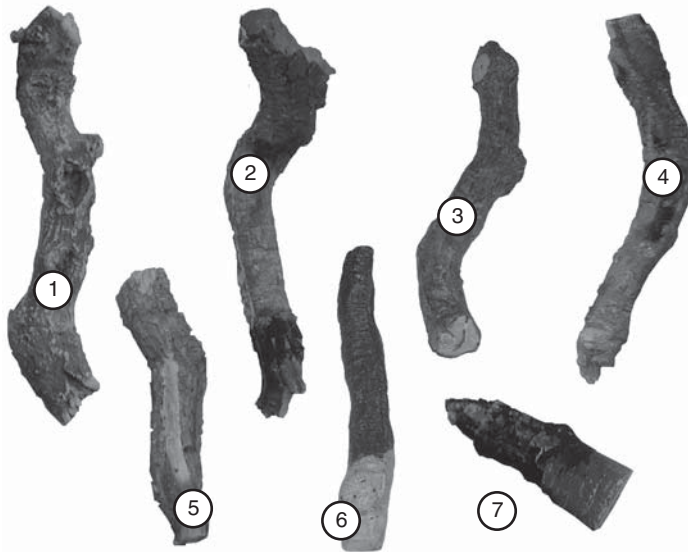

Fig. 10-1

#	Description	Part Number	Qty
1.	Knotted log	OCBWL-17	1
2.	Hooked log	OCBWL-18	1
3.	Crooked log	OCBWL-16	1
4.	Curved log	OCBWL-15	1
5.	Stripped log	OCBWL-12	1
6.	Long charred log	OCBWL-20	1
7.	Short charred log	OCBWL-9	1
8.	Lava Chunks (8-lb. bag)	OCC-8	2
9.	Volcanic Stones (box)	VS-25	1

BEACHWOOD/VOLCANIC STONE OPTION - SETUP

Although log placement may vary, suggested log placement for the Beachwood® log set is provided below. These log placements will allow for superior flame pattern and appearance. Please read these instructions completely and carefully before beginning.

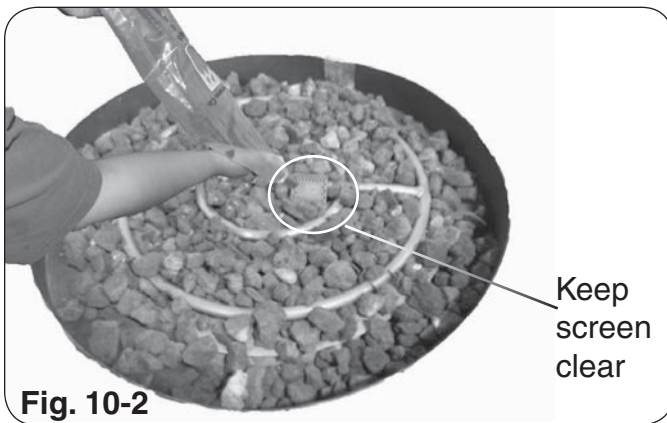

Fig. 10-2

CHUNK AND STONE PLACEMENT

WARNING: Use only parts specifically approved for use with this outdoor campfire kit. Failure to do so may result in property damage or personal injury. Check with your local Real-Fyre® dealer if you need more information.

1. Empty both bags of Lava Chunks into the burner pan (PARTS LIST, Item #8) and even it out without covering or blocking the ignitor screen (see Fig. 10-2).
2. Pour the Volcanic Stones on top to fill the whole burner pan.

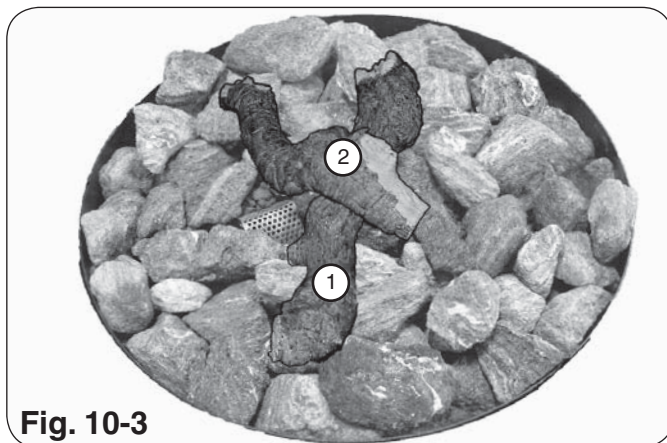

Fig. 10-3

With the ignitor screen clear of Lava Chunks and Volcanic Stones distributed on top of the Lava Chunks, nearly any log placement is possible. It is also possible to use only the Volcanic Stones and no logs at all.

Some general guidelines include always placing the flat side of each log downward or inward and making sure the logs are positioned so they are stable and will not shift or roll. Logs must remain in the burner pan when hot.

BEACHWOOD OPTION - SETUP

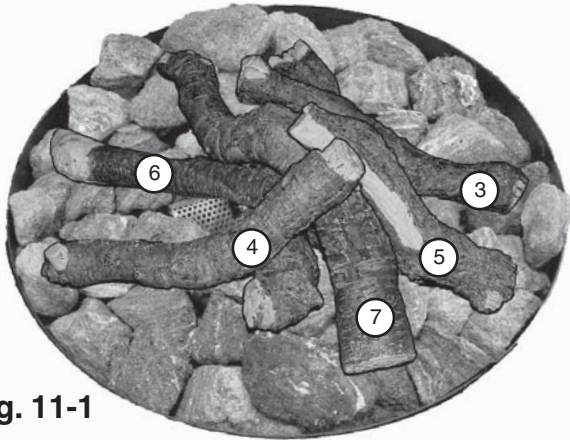

Fig. 11-1

Beachwood Log Set Other options

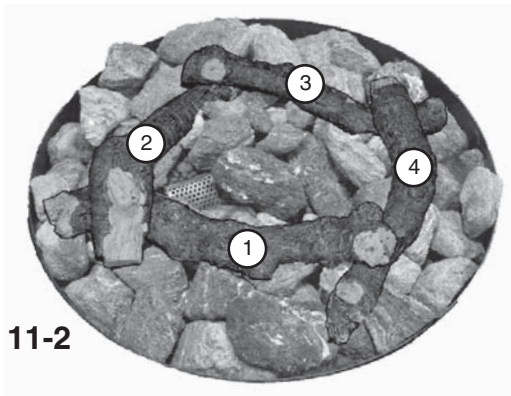

Fig. 11-2

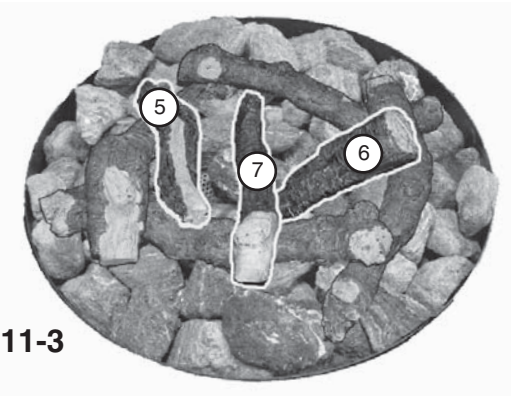

Fig. 11-3

CAUTION: THE CAMPFIRE OR DECORATIVE MEDIA WILL REMAIN HOT FOR SOME TIME AFTER USE. IF YOU NEED TO REPOSITION ANY DECORATIVE MEDIA TO MAINTAIN PROPER OPERATION, USE HEAT-RESISTANT GLOVES OR ALLOW TO COOL BEFORE HANDLING.

LOG PLACEMENT OPTION TWO - LOG SQUARE

1. Lay Log #1 across the Volcanic Stones, then lay the hooked part of Log #2 over one end of Log #1 at an angle of approximately 90 degrees (see Fig. 13-3).
2. Lay an end of Log #3 over the unattached end of Log #2 at a 90-degree angle (see Fig. 11-2).
3. Place one end of Log #4 over the open end of Log #3 and the other end underneath the open end of Log #1, creating a kind of square (see Fig. 11-2).
4. Lay the remaining logs across the already positioned logs in an attractive pattern (see Fig. 11-3).

LOG PLACEMENT OPTION THREE - LOG "TEEPEE"

1. Place the ends of three or four logs into the Volcanic Stones with their flat sides facing inward and their tops pointed upward. Then lean their other ends against each other at an angle in the center of the fire ring (see Fig. 11-4).
2. Once you have a stable set of logs to use as a "teepee" frame, place the other logs similarly as desired (see Fig. 11-5).

Enjoy your log set. After the logs are placed, consider how changing their arrangement could produce even more pleasing flame patterns. Always observe the caution at the top of this page and the guidelines on the previous page.

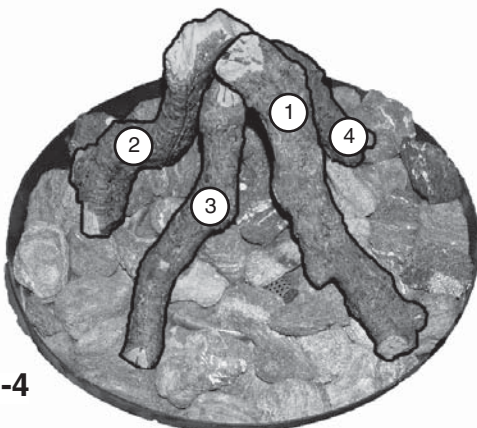

Fig. 11-4

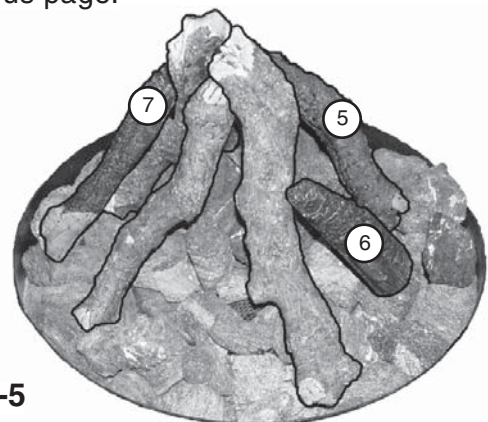

Fig. 11-5

GLASS OR RIVER ROCK ON GLASS OPTION - PARTS LIST

#	Description	Part Number	Qty
1.	Glass (10-lb. bag)	OCGL-x	3
2.	Lava Chunks (10-lb. bag)	OCC-10	1
3.	Box of river rock (optional)	STN-10	1

Replace "x" in model number with the glass code in parentheses below:

Black (B)
Clear (C)
Bronze (Z)
Sapphire blue (S)
Emerald green (E)

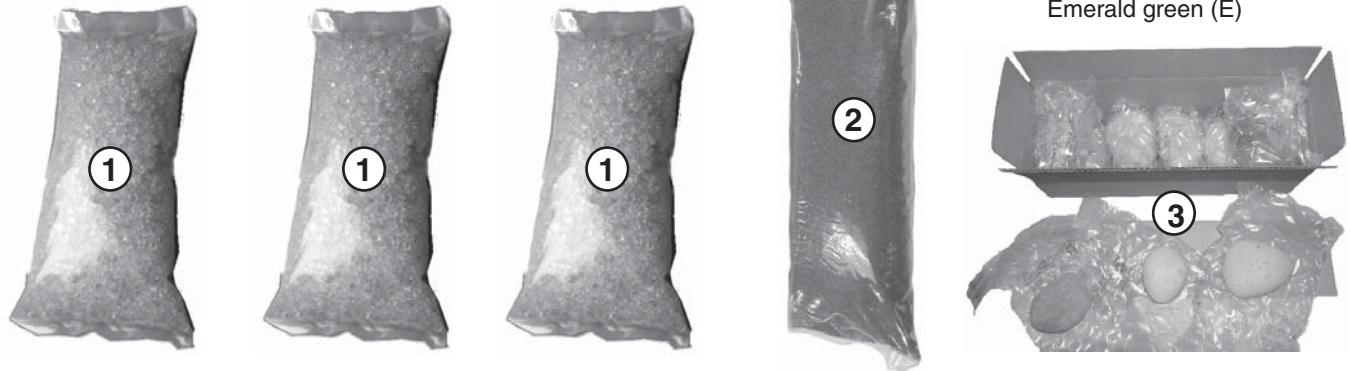

GLASS OR RIVER ROCK ON GLASS OPTION - LAVA CHUNK PLACEMENT

WARNING

This screen must be clear and free of obstructions at all times to ensure proper operation (Fig. 12-1).

LAVA CHUNK PLACEMENT

1. Pour the two (2) bags of Lava Chunks (PARTS LIST, Item #2) into the outdoor campfire, evenly covering the burner pan assembly with the exception of the screen.

CAUTION: DO NOT COVER THE SCREEN.

Screen with Lava Chunks on burner pan

**DO NOT PLACE
LAVA CHUNKS
ON THE SCREEN**

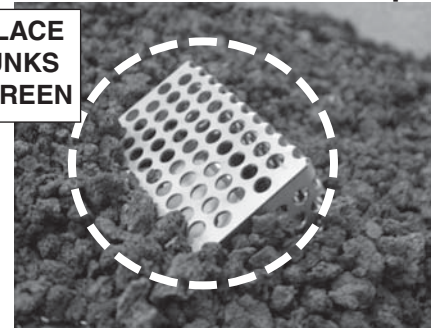

Fig. 12-1

GLASS OR RIVER ROCK ON GLASS OPTION - GLASS PLACEMENT

1. Pour the glass out of the bag(s) onto the installed outdoor campfire, evenly covering the Lava Chunks (see above) but not the screen (Fig. 12-1 and 12-2).

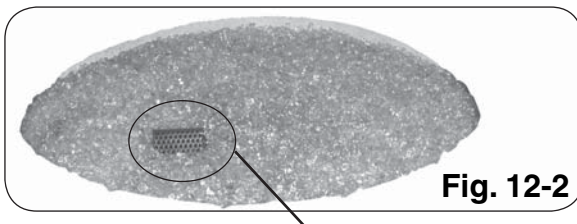
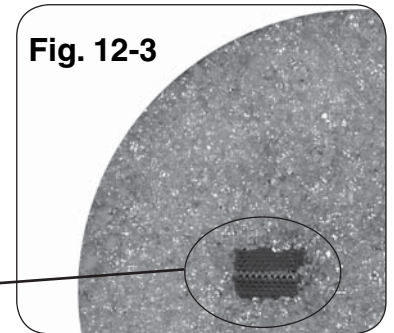

Fig. 12-2

2. Add stones as indicated below or other ornaments certified for use with this burner. (Contact your dealer for details.)

CAUTION: DO NOT COVER THE SCREEN.

Fig. 12-3



GLASS OR RIVER ROCK ON GLASS OPTION - RIVER STONE PLACEMENT

1. Place river stones in a decorative pattern on top of glass but not covering the screen.

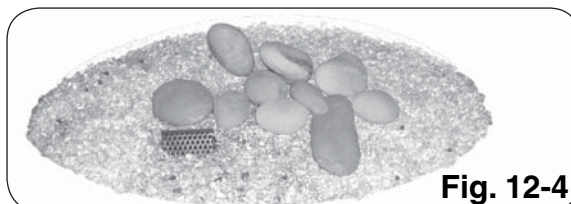
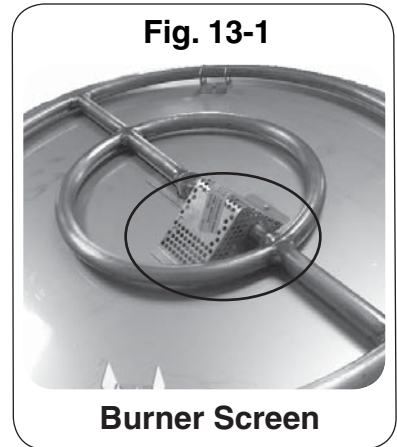

Fig. 12-4

CAUTION: THE CAMPFIRE OR DECORATIVE MEDIA WILL REMAIN HOT FOR SOME TIME AFTER USE. IF YOU NEED TO REPOSITION ANY DECORATIVE MEDIA, USE HEAT-RESISTANT GLOVES OR ALLOW TO COOL BEFORE HANDLING.

IMPORTANT OPERATIONAL SAFETY INFORMATION

- A.** Young children **MUST** be carefully supervised when in the vicinity of this appliance.
- B. DO NOT** sit or place any part of the body or combustible materials on or near the outdoor campfire surround or gas log set. Children and adults should be alerted to the hazard of high surface temperatures and should stay away to avoid burns or clothing ignition.
- C.** Every time you use your outdoor campfire, make sure that:
- 1. The outdoor campfire is clear of flammable items such as gasoline, yard debris, wood, etc.**
 - 2. THE PERFORATED BURNER SCREEN AREA IS NOT COVERED OR BLOCKED WITH LAVA CHUNKS OR ANY OTHER ITEM (see Fig. 13-1)**
 - 3. There is no blockage of the airflow through any vent screens located in your enclosure unit.**
- D. WARNING: HOT WHILE IN USE AND FOLLOWING OPERATION.**
Children must be supervised when in the vicinity of this appliance. Serious injury may occur! **DO NOT** throw trash, paper, or other flammable materials onto your outdoor campfire. **DO NOT** leave in operation when unattended.
- WARNING: DO NOT operate this outdoor campfire in the rain.**
- E. SOLID FUEL MUST NOT BE BURNED** in the enclosure where your outdoor campfire kit is installed.
- F. DO NOT** continue using if you smell unusual odors, or have headaches, nausea, or dizziness.
- G. DO NOT** store any combustible materials, gasoline, and any other flammable vapors/liquids around the area of your outdoor campfire. Provide adequate clearance for servicing and operation.
- H. DO NOT** place clothing or any flammable material on or near your outdoor campfire. Matches, paper, garbage, or any other material must not be thrown on top of the logs, burner, or into the flame.
- I. DO NOT** use your outdoor campfire if any part of it has been underwater. Immediately call a qualified professional service technician to inspect the set and to replace any part of the control system that has been underwater.



REPLACING BATTERIES

TO INSTALL/REPLACE BATTERY IN SPARK GENERATOR.

- A.** Carefully unscrew the complete generator cap (Fig. 13-2).
- B.** Withdraw the existing battery and spring (Fig. 13-3); detach the battery, taking care not to lose the spring.
- C.** Insert a new battery base first (negative end first) into the spring.
- D.** Insert the battery and spring into the generator (Fig. 13-3) and replace the cap, screwing down (Fig. 13-2) until snug. Do not overtighten.

Always replace with new, unused batteries to ensure good spark generation.

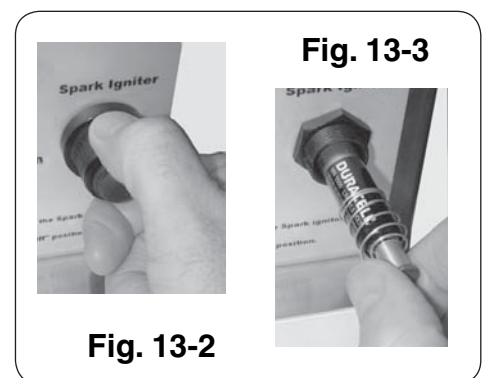

OPERATING THE MANUAL OUTDOOR CAMPFIRE

FOR YOUR SAFETY, READ BEFORE LIGHTING

WARNING

IF YOU DO NOT FOLLOW THESE INSTRUCTIONS EXACTLY, A FIRE OR EXPLOSION MAY RESULT, CAUSING PROPERTY DAMAGE, PERSONAL INJURY, OR LOSS OF LIFE.

- A. BEFORE LIGHTING**, smell all around the outdoor campfire area for gas. Be sure to smell next to the ground, because some gas is heavier than air and will settle on the floor.
- B. WHAT TO DO IF YOU SMELL GAS**
1. Shut off the gas to the appliance.
 2. Extinguish any open flame.
 3. If odor continues, immediately call your gas supplier or the fire department.
- C.** Use only your hand to push in or turn the gas control knob. Never use tools. If the knob will not push in or turn by hand, **DO NOT** try to repair it. Call a qualified professional service technician. Force or attempted repair may result in fire or explosion.
- D. DO NOT** use the outdoor campfire if any part has been underwater. Immediately call a qualified service technician to inspect the outdoor campfire and to replace any part of the control system and any gas control that has been underwater.

MANUAL UNIT LIGHTING INSTRUCTIONS

1. **STOP!** Read the safety information above.
2. Press and hold the electric ignitor button. The ignitor will begin to spark with a rapid clicking sound.
3. While holding the ignitor button in, push in the ON/OFF control knob to open the gas valve. The main burner will ignite **AT THE MAXIMUM BTU INPUT**.
4. Continue to hold knob for 10-15 seconds - this will allow the safety valve to activate and the main burner will remain lit. Turn ON/OFF control knob to adjust flame height. If unit fails to light at step 4 after five (5) seconds, **STOP**, turn control knob to **OFF**, and repeat steps 2 & 3.

Fig. 14-1

Follow the instructions on the control panel face to light the campfire.

Note: Here the ON/OFF valve is in the **OFF** position

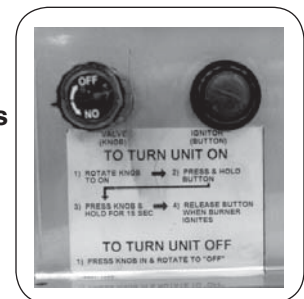

Note: The outdoor campfire should remain lit. If it goes out or fails to light, wait five (5) minutes to clear out any gas and repeat steps 1 through 3.

- If the safety pilot valve does not activate, and the gas does not light, **STOP**. Immediately call your service technician or gas supplier.
- If the outdoor campfire will not stay lit after several tries, turn the gas control knob to **OFF** and call your service technician or gas supplier.

To turn the unit off, turn the ON/OFF valve fully to **OFF**.

CONVERTING YOUR CAMPFIRE TO A DIFFERENT GAS TYPE

To convert your outdoor campfire kit from propane to natural gas or from natural to propane gas, carefully follow the steps below:

1. **SHUT OFF THE GAS SUPPLY TO THE CAMPFIRE AND ANY NEARBY ELECTRICAL SOURCES OR APPLIANCES.**
2. If present, remove all decorative media from the outdoor campfire enclosure.
3. Remove the four (4) screws attaching the burner pan to your fire ring or enclosure.
4. Detach the thermocouple (taking care not to kink it) from the safety valve (see Fig. 15-2 for location).
5. Carefully detach the flex connector attached to the fuel injector or air mixer (see Fig. 15-4) and unscrew the air mixer from the burner pipe.
6. Replace the fuel injector/air mixer with the air mixer/fuel injector supplied in the conversion kit and reattach the connector from the valve (see Fig. 15-4). The regulator must now be converted to the new gas type.
7. The regulator is situated after the valve (see Fig. 15-2), behind the control panel. To convert the regulator to the required gas type:
 - a) Unscrew and remove the cap (see Fig. 15-1) from the regulator, extracting the converter.



- Note:** As installed, the regulator cap may be located underneath the regulator. If necessary, carefully rotate the regulator to access the cap.
- b) Remove the converter (the red plastic stalk, Fig. 15-1) by carefully pulling it away from the center of the cap (it will snap out of its seating).
 - c) Turn the converter around and replace it carefully into the center of the cap (it will snap into place). **Check that you can read the type of gas the unit is set for.**

Note: EACH END OF THE PLASTIC CONVERTER IS EMBOSSED WITH EITHER THE LETTERS “NAT” OR “L.P.” FOR THE RESPECTIVE GAS TYPE (NAT. for natural - L.P. for propane). WHEN THE CONVERTER IS IN THE CAP AND THE CAP HELD UPPERMOST, THE LETTERS SEEN (at the bottom of the stalk) INDICATE THE GAS THAT THE REGULATOR IS SET UP FOR. (Fig. 15-1 shows the converter set for propane gas.)

- d) Replace the cap and converter into the regulator and screw down until snug.
8. Once the above steps are complete, reattach the thermocouple and ignitor wires (steps 4-5 in reverse). Fasten the burner pan back into place on the outdoor campfire ring.
9. Restore your gas supply and check for leaks, using soapy water. When no leaks are detected, replace the decorative media.

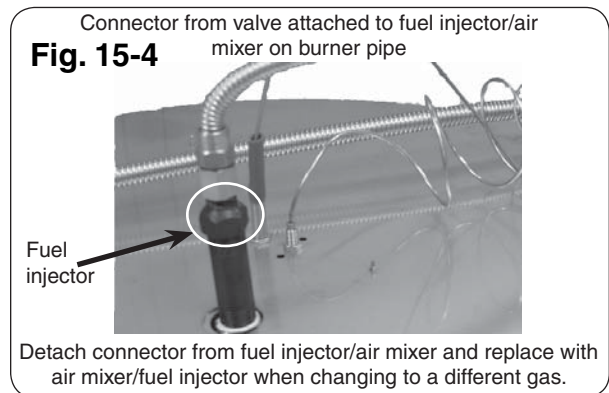
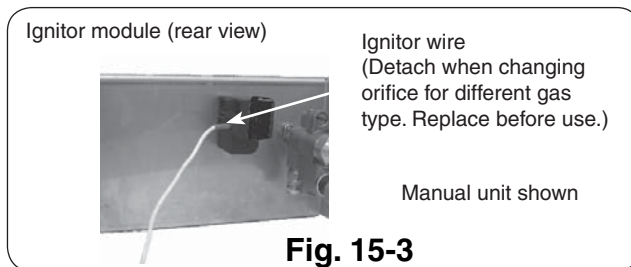
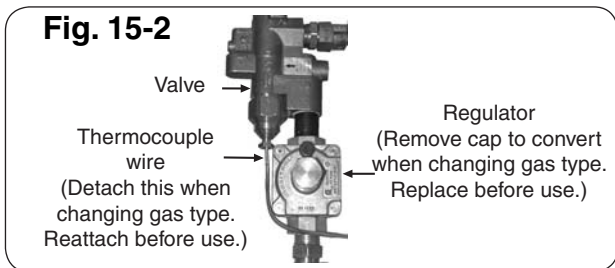

Detach connector from fuel injector/air mixer and replace with air mixer/fuel injector when changing to a different gas.

PETERSON CAMPFYRE LIMITED WARRANTY

THREE (3) YEAR LIMITED WARRANTY

All Peterson Outdoor Campfyre logs, enclosures, and burner component parts, (except valves and controls) are covered by a three (3) year limited warranty.

All Peterson valves and controls are covered by a separate one (1) year limited warranty (excluding batteries).

PLEASE KEEP A COPY OF YOUR SALES SLIP FOR PROOF OF PURCHASE

This warranty applies to the original purchaser and to single family residential use only. It commences from date of purchase, and is valid only with proof of purchase.

This warranty does not cover parts becoming defective through misuse, accidental damage, electrical damage, improper handling, storage, and/or installation. Product must be installed (and gas must be connected) as specified in the instructions or operator's manual, by a **qualified professional installer**. Accessories, parts, valves, remotes, etc., when used must be Peterson Co. product.

This warranty **does not** apply to rust, corrosion, oxidation, or discoloration, unless the affected component becomes inoperable. It **does not** cover labor or labor-related charges.

This warranty specifically excludes liability for **indirect, incidental**, or consequential damages. Some states do not allow the exclusion or limitation of incidental or consequential damages, so the above exclusion may not apply to you. This warranty gives you specified legal rights, and you may have other rights that may vary from state to state.

For additional information regarding this warranty, or to place a warranty claim, contact the R.H. Peterson dealer where the product was purchased.

**TO REGISTER YOUR PRODUCT ONLINE GO TO: WWW.RHPETERSON.COM,
AND CLICK ON PRODUCT REGISTRATION. THANK YOU FOR YOUR PURCHASE.**

ROBERT H. PETERSON CO.

Quality Check

Date: _____

Orifice # (Main): _____

Orifice # (Other): _____

Leak Test: _____

Burn Test: _____

Gas Type: NAT. / PROPANE

Model #: _____

Serial #: _____

Air Shutter: _____

Inspector: _____

Robert H. Peterson Co. • 14724 East Proctor Avenue • City of Industry, CA 91746