



Model: LPK#44

Natural Gas to LP Gas Conversion Kit

THIS CONVERSION KIT MUST BE CONVERTED BY A QUALIFIED GAS FITTER/SERVICE COMPANY. IF YOU DO NOT UNDERSTAND HOW TO COMPLETE THIS PROCESS THEN DO NOT CONVERT THIS APPLIANCE!

This LP Kit contains the following: 1 - OAS-LP44 (Brass orifice with a #44 hole), 1 - Decal label (placed next to rating plate), 1 - Installation instruction

1. Turn the fire pit and main gas supply OFF.
2. Ensure the fire pit is cool before converting.
3. Remove all media from the burner pan.
4. Remove the burner pan from the enclosure
5. Disconnect the 1/2" flex connector from the OAS.
6. Remove the 1/2" NPT Female to Male flared fitting from the old OAS (See Fig. 1).
7. Remove the old OAS. NOTE: Brass nut and large washer will remain attached.
8. Apply Teflon tape or pipe compound resistant to all gasses to burner threads.
9. Install the new OAS-LP.
10. Apply Teflon tape or pipe compound resistant to all gasses to the OAS-LP threads.
11. Install the 1/2" NPT Female to Male flared to the new OAS-LP (See Fig. 2).
12. Ensure a LP regulator is installed at the main gas supply before operating.
13. Fill out the label "This fire pit has been converted to LP gas" and adhere the blank area on rating plate.
14. Check all gas connections for leaks before and during operation with soapy water.
15. Conversion is now complete.

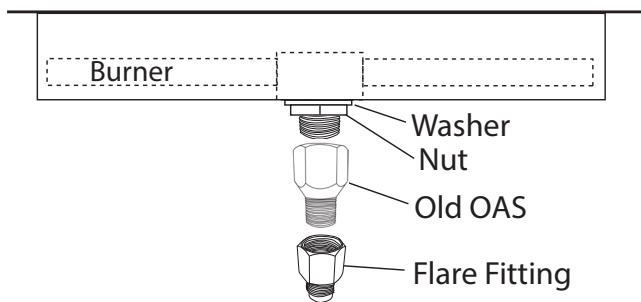

Fig. 1 Removing old OAS

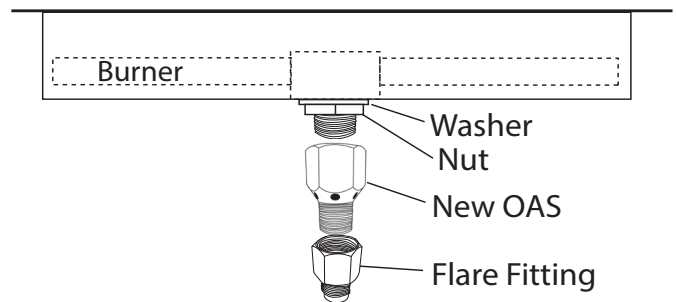

Fig. 2 Installing new OAS

For Technical Service Call: (855) 498-8324

Firegear Outdoors
9230 Conservation Way
Fort Wayne, IN 46809
For Sales: (888) 672-8929
Web Site: www.firegearoutdoors.com

⚠ WARNING! | CALIFORNIA PROPOSITION 65

This product can expose you to Lead, which is known to the state of California to cause cancer and birth defects or other reproductive harm. (For more information, go to www.p65warnings.ca.gov)