

VENT FREE STOVE SERIES

NATURAL OR LIQUID PROPANE GAS STOVE HEATER
OWNER'S OPERATION AND INSTALLATION MANUAL



CVFB200
TOWNSEND II



ANS Z21.11.2b-2010



C100BA
HEPPLEWHITE

WARNING: If the information in this manual is not followed exactly, a fire or explosion may result causing property damage, personal injury or loss of life.

— Do not store or use gasoline or other flammable vapors and liquids in the vicinity of this or any other appliance.

WHAT TO DO IF YOU SMELL GAS

- Do not try to light any appliance.
- Do not touch any electrical switch; do not use any phone in your building.
- Immediately call your gas supplier from a neighbor's phone. Follow gas supplier's instructions.
- If you cannot reach your gas supplier, call fire department.
- Installation and service must be performed by a qualified installer, service agency or the gas supplier.

“This appliance is intended for supplemental heating.”

“This heater shall not be installed in a bedroom or bathroom.”

WARNING: Improper installation, adjustment, alteration, service or maintenance can cause injury or property damage. Refer to this manual for correct installation and operational procedures. For assistance or additional information consult a qualified installer, service agency or gas supplier.

WARNING: This is an unvented gas-fired heater. It uses air (oxygen) from the room in which it is installed. Provisions for adequate combustion and ventilation air must be provided. Refer to *Air for Combustion and Ventilation* section on page 4 of this manual.

WARNING: If the information in this manual is not followed exactly, a fire or explosion may result causing property damage, personal injury or loss of life.

This appliance may be installed in an aftermarket*, permanently located, manufactured (mobile) home, where not prohibited by state or local codes.

This appliance is only for use with the type of gas indicated on the rating plate.

This appliance is not convertible for use with other gases.

* Aftermarket: Completion of sale, not for purpose of resale, from the manufacturer

INSTALLER: Leave this manual with appliance.

CONSUMER: Retain this manual for future reference.

MANUFACTURED BY NEW BUCK
CORPORATION
200 ETHAN ALLEN DRIVE, PO BOX 69
SPRUCE PINE, N.C. 28777

www.buckstove.com

WARNING: Only New Buck Corporation approved blower assembly, part number MA CVF714, may be used with the CVFB200 unit only.

January 2013

TABLE OF CONTENTS

SAFETY INFORMATION.....	1
IDENTIFICATION NUMBERS AND DESCRIPTIONS.....	2
AIR FOR COMBUSTION AND VENTILATION	4-6
UNPACKING STOVE ASSEMBLY	7
INSTALLATION OF OPTIONAL BLOWER (ONLY) FOR VENT FREE STOVE SERIES TOWNSEND II	8
INSTALLATION:	
CLEARANCES	9
CONNECTING GAS SUPPLY	10
PRESSURE TESTING.....	11
INSTALLATION / POSITIONING OF LOGS:	
VENT FREE STOVE SERIES TOWNSEND II	12-13
VENT FREE STOVE SERIES HEPPLEWHITE.....	14-15
OPERATING HEATER:	
FOR YOUR SAFETY	16
LIGHTING INSTRUCTIONS (SIT) MILLIVOLT	17
MANUAL LIGHTING PROCEDURE	17
OPTIONAL REMOTE CONTROL.....	17
PILOT FLAME PATTERN	17
FRONT ACCESS TO (SIT) MILLIVOLT VALVE	18
INSPECTING / CLEANING	19
TROUBLE SHOOTING	20
PARTS LIST	23
REPLACEMENT PARTS	24
ACCESSORIES	25
WIRING DIAGRAM:	
VENT FREE STOVE SERIES CVFB200.....	26
VENT FREE STOVE SERIES C100BA	27
WARRANTY	28
OWNER REGISTRATION CARD	BACK COVER

VENT FREE STOVE SERIES SAFETY INFORMATION

WARNINGS:

IMPORTANT: Read this owner's manual carefully and completely before trying to assemble, operate or service this heater. Improper use of this heater can cause serious injury or death from burns, fire, explosion, electrical shock and carbon monoxide poisoning.

DANGER: Carbon monoxide poisoning may lead to death!

NOTE: When burning any unit or appliance that combusts fuel for heat, such as coal, oil, wood or natural and (L.P.) liquid petroleum gas. We highly recommend the use of smoke and carbon monoxide detectors in your home.

Carbon Monoxide Poisoning: Early signs of carbon monoxide poisoning resemble the flu, with headaches, dizziness or nausea. If you have these signs, heater may not be working properly. **Get fresh air at once!** Have heater serviced. Some people are more affected by carbon monoxide than others. These include pregnant women, people with heart or lung disease or anemia, those under influence of alcohol and those at high altitudes.

Make certain you read and understand all **Warnings**. Keep this manual for reference. It is your guide to safe and proper operation of this heater.

WARNING: Any change to this heater or its controls can be dangerous.

WARNING: Do not allow fans to blow directly into the stove. Avoid any drafts that alter burner flame patterns. Ceiling fans can create drafts that alter burner flame patterns. Altered burner patterns can cause sooting.

WARNING: Do not use a blower insert, heat exchanger insert or other accessory not approved for use with this heater.

Due to high temperatures the appliance should be located out of traffic and away from furniture and draperies.

Do not place clothing or other flammable material on or near appliance. Never place any objects on heater.

Stove becomes very hot when running heater. Keep children and adults away from hot surfaces to avoid burns or clothing ignition. Stove will remain hot for a time after shutdown. Allow surfaces to cool before touching.

Carefully supervise young children when they are in the room with heater. When using handheld remote accessory, keep selector switch in OFF position to prevent children from turning on burners with remote.

Keep appliance area clear and free from combustible materials, gasoline and other flammable vapors and liquids.

1. This appliance is only for use with the type of gas indicated on rating plate. This appliance is not convertible for use with other gases.
2. If you smell gas
 - shut off gas supply
 - do not try to light any appliance
 - do not touch any electrical switch: do not use any phone in your building
 - immediately call your gas supplier from a neighbor's phone. Follow gas supplier's instructions
 - if you cannot reach your gas supplier, call fire department
3. This heater shall not be installed in a bedroom or bathroom.
4. Do not use this stove as a wood burning fireplace. Use only models: CVFB200(LP), CVFB200(NAT), C100BA(LP) or C100BA(NAT) series vent-free gas log heater.

3. Do not add extra logs or ornaments such as pine cones, vermiculite or rock wool. Using these added items can cause sooting.

6. During initial operation, slight smoking could occur due to heater burning manufacturing residues.
7. To prevent creation of soot, follow instructions in "Cleaning and Maintenance", page 19.
8. Before using furniture polish, wax, carpet cleaners or similar products, turn heater off. If heated, vapors from these products may create a white powder residue within burner box or on adjacent walls or furniture.
9. This heater has an Oxygen Depletion Sensing (ODS) safety shutoff system. The ODS shuts down heater if not enough fresh air is available. See "Air for Combustion and Ventilation", pages 3 through 5. If heater keeps shutting off, see "Troubleshooting", pages 20 through 22.
10. Do not run heater
 - where flammable liquids or vapors are used or stored
 - under dusty conditions
11. Do not use this stove to cook food or burn paper or other objects.
12. Do not use heater if any part has been exposed to or under water. Immediately call a qualified service technician to inspect room heater and to replace any part of control system and any gas control which has been under water.
13. Do not operate heater if any log is broken.
14. Turn heater off and let cool before servicing. Only a qualified service person should service and repair heater.
15. Operating heater above elevations of 4,500 feet could cause pilot outage.
16. Do not place stove directly on carpeting, vinyl tile or any combustible material other than wood. The stove must set on a metal or wood panel extending the full width and depth of the appliance.

IDENTIFICATION NUMBERS AND DESCRIPTIONS FOR VENT FREE STOVE SERIES

CVFB200 TOWNSEND II

<u>ID#</u>	<u>MODEL COLOR</u>
CVFB200-A	ALMOND
CVFB200-B	BLACK
CVFB200-G	GREEN
CVFB200-R	TERRACOTTA
CVFB200-PV	VINTAGE COPPER

<u>ID#</u>	<u>TYPE OF GAS</u>
CVFB200(LP)	LIQUID PROPANE
CVFB200(NAT)	NATURAL

<u>ID#</u>	<u>OPTIONAL BLOWER ASSEMBLY CVFB200 ONLY</u>
MA CVF714	BLOWER ASSEMBLY

C100BA HEPPLWHITE

<u>ID#</u>	<u>MODEL COLOR</u>
C100BA-A	ALMOND
C100BA-B	BLACK
C100BA-G	GREEN
C100BA-R	TERRACOTTA
C100BA-PV	VINTAGE COPPER

<u>ID#</u>	<u>TYPE OF GAS</u>
C100BA(TLP)	LIQUID PROPANE
C100BA(NAT)	NATURAL

PRODUCT IDENTIFICATION

MODELS C100BA(LP), C100BA(NAT) OR CVFB200(LP), CVFB200(NAT) MILLIVOLT VENT FREE UNITS.

PRODUCT FEATURES

OPERATION

This heater is clean burning. It requires no outside venting. There is no heat loss out a vent or up a chimney. Heat is generated by realistic, dancing yellow flames. This heater is designed for vent-free operation. State and local codes in some areas prohibit the use of vent-free heaters.

SAFETY PILOT

This heater has a pilot with an Oxygen Depletion Sensing (ODS) safety shutoff system. The ODS/pilot is a required feature for vent-free room heaters. The ODS/pilot shuts off the heater if there is not enough fresh air.

PIEZO IGNITION SYSTEM

This heater has a piezo ignitor. This system requires no matches, batteries, or other sources to light heater.

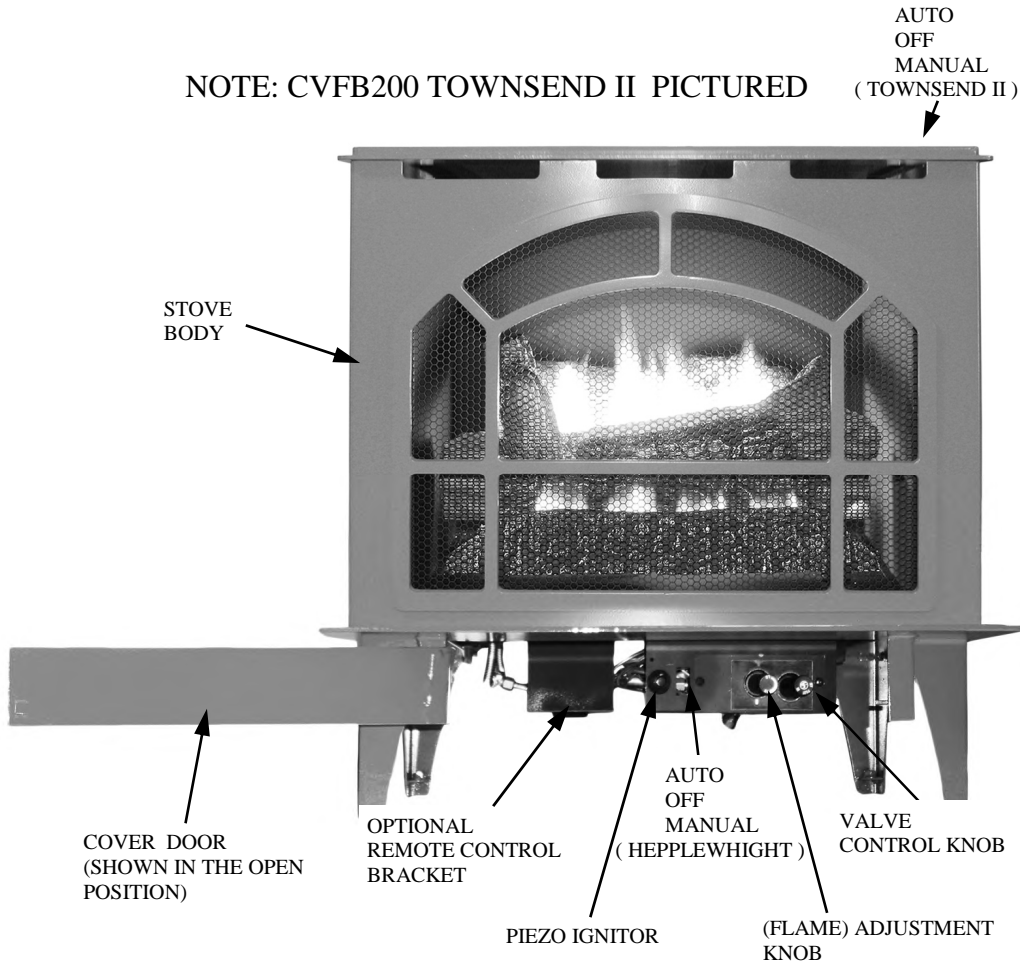

LOCAL CODES

Install and use heater with care. Follow all local codes. In absence of local codes, use latest edition of "The National Fuel Gas Code ANSI Z223.1", also know as NFPA 54*.

*Available from:

American National Standards Institute Inc.
1430 Broadway
New York, NY 10018
National Fire Protection Association, Inc.
Batterymarch Park
Quincy, MA 02269

AIR FOR COMBUSTION AND VENTILATION FOR C100BA, CFVB200 VENT FREE STOVE SERIES

WARNING: This heater shall not be installed in a unusually tight construction unless provisions are provided for adequate combustion and ventilation air. Read the following instructions to ensure proper fresh air for this and other fuel-burning appliances in your home.

Today's homes are built more energy efficient than ever. New materials, increased insulation and new construction methods help reduce heat loss in homes. Home owners weather strip and caulk around windows and doors to keep the cold air out and the warm air in. During heating months, home owners want their homes as airtight as possible.

While it is good to make your home energy efficient, your home needs to breathe. Fresh air must enter your home. All fuel-burning appliances need fresh air for proper combustion and ventilation.

Exhaust fans, fireplaces, clothes dryers and fuel burning appliances draw air from the house to operate. You must provide adequate fresh air for these appliances.

PROVIDING ADEQUATE VENTILATION

The following are excerpts from *National Fuel Gas Code, NFPA 54/ANSI Z223.1, Section 5.3, Air for Combustion and Ventilation*.

All spaces in homes fall into one of the two following ventilation classifications:

1. Unusually Tight Construction
2. Unconfined Space

The information on pages 4 through 5 will help you classify your space and provide adequate ventilation.

Unusually Tight Construction

The air that leaks around doors and windows may provide enough fresh air for combustion and ventilation. However, in buildings of unusually tight construction, you must provide additional fresh air.

Unusually tight construction is defined as construction where:

- a **Walls and ceilings exposed to the outside atmosphere have a continuous water vapor retarder with a rating of one perm (6×10^{-11} kg per pa-sec- m^2) or less with openings gasketed or sealed and**
- b **Weather stripping has been added on openable windows and doors and**
- c **Caulking or sealants are applied to areas such as joints around window and door frames, between sole plates and floors, between wall-ceiling joints, between wall panels, at penetrations for plumbing, electrical and gas lines and at other openings.**

If your home meets all of the two criteria above, you must provide additional fresh air. See *Ventilation Air From Outdoors*, page 5.

If your home does not meet all of the three criteria above, proceed to *Determining Fresh-Air Flow For Heater Location*, page 4.

Unusually Tight Construction or Unconfined Space

The *National Fuel Gas Code, ANSI Z223.1* defines a **unusually tight construction** as a space whose volume is less than 50 cubic feet per 1,000 Btu per hour (4.8 m^3 per kw) of the aggregate input rating of all appliances installed in that space; and **unconfined space** as a space whose volume is not less than 50 cubic feet per 1,000 Btu per hour (4.8 m^3 per kw) of the aggregate input rating of all appliances installed in that space. Rooms communicating directly with the space in which the appliances are installed*, through openings not furnished with doors, are considered a part of the unconfined space.

This heater shall not be installed in a unusually tight construction unless provisions are provided for adequate combustion and ventilation air.

*Adjoining rooms are communicating only if there are doorless passageways or ventilation grills between them.

Installation and repair should be done by a qualified service person. The appliance should be inspected before each use and at least annually by a professional service person. More frequent cleaning may be required due to excessive lint from carpeting, bedding material, pet hair, etc. It is imperative that control compartments, burners and circulating air passageways of the appliance be kept clean.

WARNING: Any change to this heater or its controls can be dangerous.

“WARNING: IF THE AREA IN WHICH THE HEATER MAY BE OPERATED DOES NOT MEET THE REQUIRED VOLUME FOR INDOOR COMBUSTION AIR, COMBUSTION AND VENTILATION AIR SHALL BE PROVIDED BY ONE OF THE METHODS DESCRIBED IN THE NATIONAL FUEL GAS CODE, ANSI Z223.1/NFPA 54, THE INTERNATIONAL FUEL GAS CODE, OR APPLICABLE CODES.”

AIR FOR COMBUSTION AND VENTILATION

Continued

DETERMINING FRESH-AIR FLOW FOR HEATER LOCATION

Determining if You Have A Unusually Tight Construction or Unconfined Space

Use this work sheet to determine if you have a unusually tight construction or unconfined space.

Space: Includes the room in which you will install heater plus any adjoining rooms with doorless passageways or ventilation grills between the rooms.

1. Determine the volume of the space (length x width x height).

Length x Width x Height = _____ cu. Ft. (volume of space)

Example: Space size 20 ft. (length) x 16 ft. (width) x 8 ft. (ceiling height) = 2560 cu. Ft. (volume of space)
if additional ventilation to adjoining room is supplied with grills or openings, add the volume of these rooms to the total volume of the space.

2. Divide the space volume by 50 cubic feet to determine the maximum Btu/Hr the space can support.

_____ (volume of space) / 50 cu. Ft. = (maximum Btu/Hr the space can support)

Example: 2560 cu. Ft. (volume of space) / 50 cu. Ft. = 51,200 (maximum Btu/Hr the space can support)

3. Add the Btu/Hr of all fuel burning appliances in the space.

Vent-free heater _____ Btu/Hr

Gas water heater* _____ Btu/Hr

Gas furnace _____ Btu/Hr

Vented gas heater _____ Btu/Hr

Gas fireplace logs _____ Btu/Hr

Other gas appliances* + _____ Btu/Hr

Total = _____ Btu/Hr

Example:

Gas water heater 40,000 Btu/Hr

Vent-free heater + 30,000 Btu/Hr

Total = 70,000 Btu/Hr

* Do not include direct-vent gas appliances. Direct-vent draws combustion air from the outdoors and vents to the outdoors.

4. Compare the maximum Btu/Hr the space can support with the actual amount of Btu/Hr used.

_____ Btu/Hr (maximum the space can support)

_____ Btu/Hr (actual amount of Btu/Hr used)

Example: 51,200 Btu/Hr (maximum the space can support)

70,000 Btu/Hr (actual amount of Btu/Hr used)

The space in the above example is a unusually tight construction because the actual Btu/Hr used is more than the maximum Btu/Hr the space can support. You must provide additional fresh air. Your options are as follows:

- A. Rework worksheet, adding the space of an adjoining room. If the extra space provides an unconfined space, remove door to adjoining room or add ventilation grills between rooms. See *Ventilation Air From Inside Building*, page 5.
- B. Vent room directly to the outdoors. See *Ventilation Air From Outdoors*, page 5.
- C. Install a lower Btu/Hr heater, if lower Btu/Hr size makes room unconfined.

If the actual Btu/Hr used is less than the maximum Btu/Hr the space can support, the space is an unconfined space. You will need no additional fresh air ventilation.

“Warning: If the area in which the heater may be operated does not meet the required volume for indoor combustion air, combustion and ventilation air shall be provided by one of the methods described in the National Fuel Gas Code, ANSI Z223.1/NFPA 54, the International Fuel Gas Code or applicable local codes.”

AIR FOR COMBUSTION AND VENTILATION

Continued

VENTILATION AIR

VENTILATION AIR FROM INSIDE BUILDING

This fresh air would come from an adjoining unconfined space. When ventilating to an adjoining unconfined space, you must provide two permanent openings; one within 12" of the ceiling and one within 12" of the floor on wall connecting the two spaces (See Options 1 and 2, Figure 2). You can also remove door into adjoining room (See Option 3, Figure 2). Follow the *National Fuel Gas Code, NFPA 54/ANSI Z223.1, Section 5.3, Air for Combustion and Ventilation* for required size of ventilation grills or ducts.

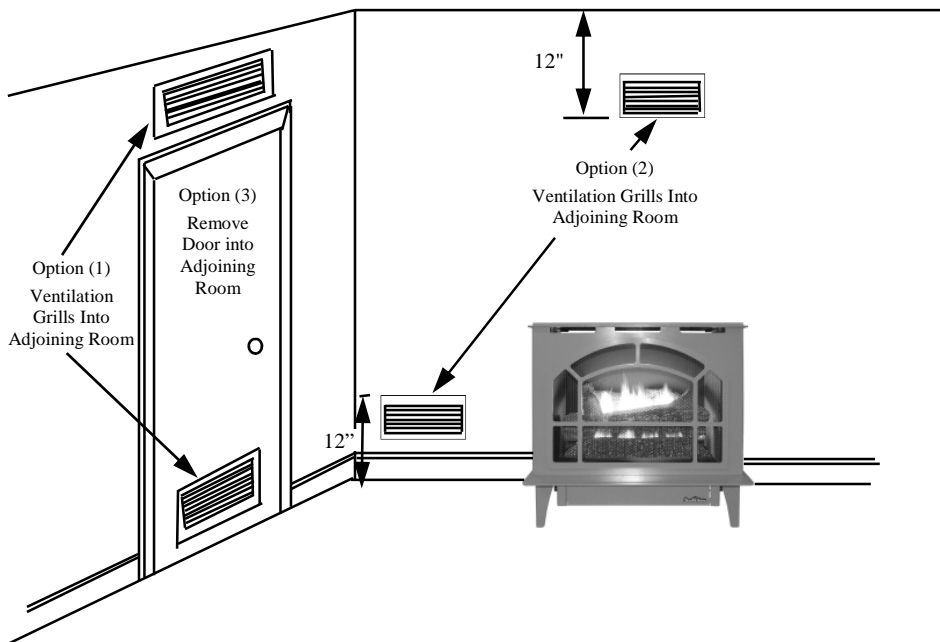

FIGURE 2 - VENTILATION AIR FROM INSIDE BUILDING

WARNING: Rework worksheet, adding the space of the adjoining unconfined space. The combined spaces must have enough fresh air to supply all appliances in both spaces.

NOTE: TYPICAL STOVE CABINET MODEL

Ventilation Air From Outdoors

Provide extra fresh air by using ventilation grills or ducts. You must provide two permanent openings: one within 12" of the ceiling and one within 12" of the floor. Connect these items directly to outdoors or spaces open to outdoors. These spaces include attics and crawl spaces. Follow the *National Fuel Gas Code, NFPA 54/ANSI Z223.1, Section 5.3, Air for Combustion and Ventilation* for required size of ventilation grills or ducts. (See Figure 3).

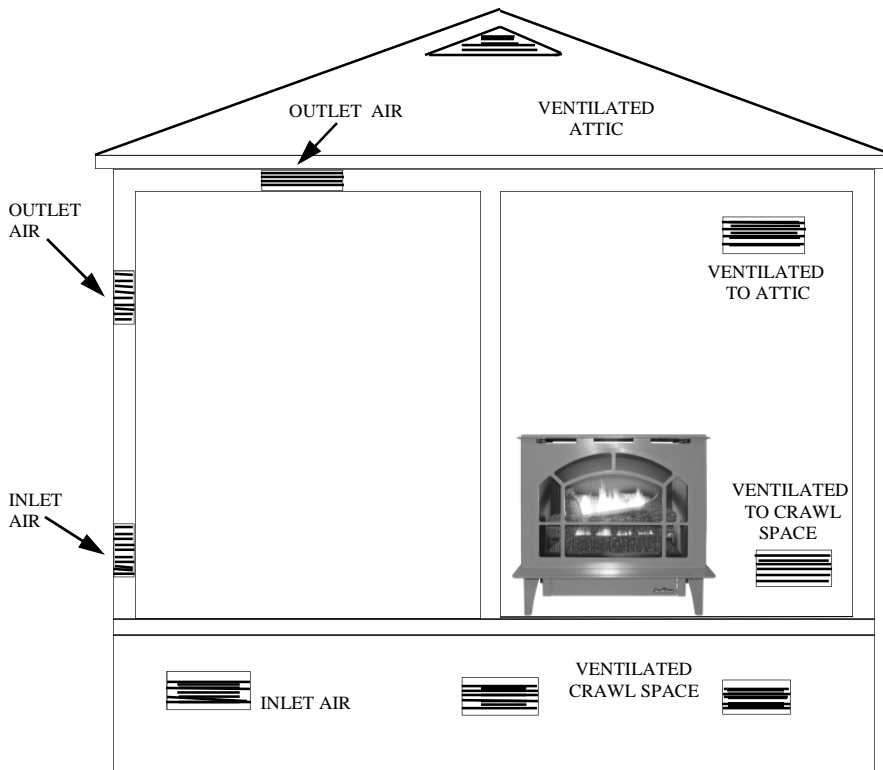
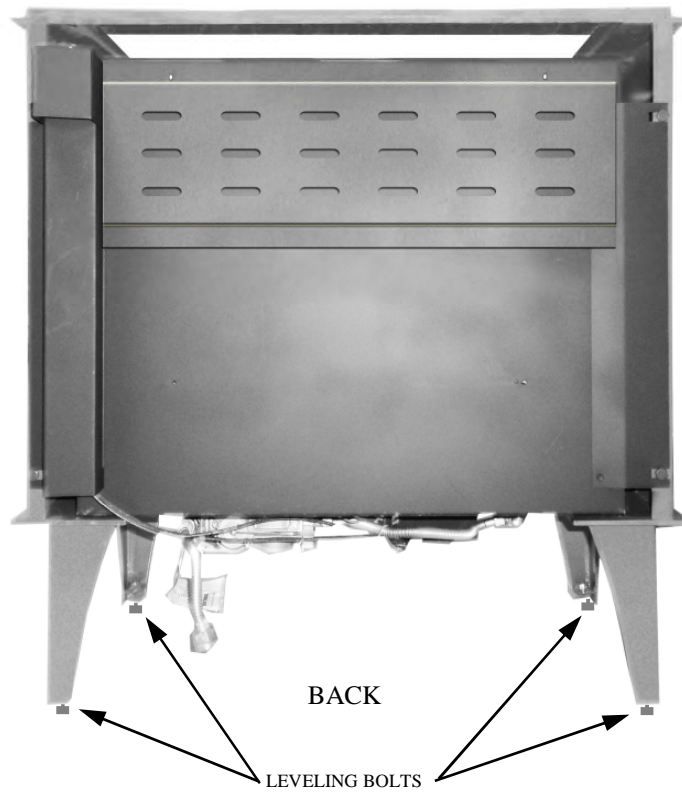

FIGURE 3 - VENTILATION AIR FROM OUTDOORS

IMPORTANT: Do not provide openings for inlet or outlet air into attic, if attic has a thermostat-controlled power vent. Heated air entering the attic will activate the power vent.

UNPACKING STOVE ASSEMBLY FOR CVFB200, C100BA VENT FREE STOVE SERIES

1. Carefully remove corrugated box enclosing stove, leaving unit on pallet at this time. Remove box that contains logs, also remove Top Grate from stove and set aside. Top Grate will be placed on unit after being installed in desired location
2. Using phillips head screwdriver, move screws from hold down brackets on two of the legs.
3. Using drop cloth or blanket to protect floor, carefully lay stove body on back. Remove hold down brackets from the two legs by unscrewing two bolts holding brackets. Now replace two bolts in bottom of legs. The bolts are used for leveling adjusters. Place unit in upright position. (See Figure 4).



NOTE: TYPICAL STOVE CABINET MODEL

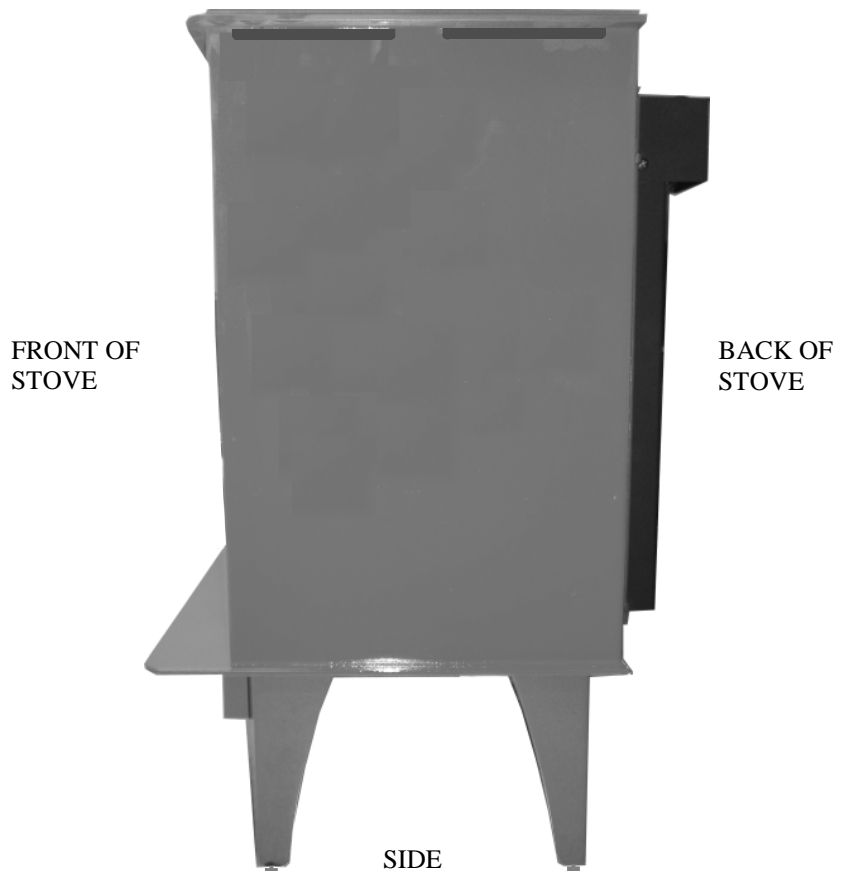

FIGURE 4

INSTALLATION OF OPTIONAL BLOWER ASSEMBLY FOR VENT FREE STOVE SERIES MODEL CVFB200(LP) OR CVFB200(NAT) TOWNSEND II ONLY.

NOTE: If optional blower assembly is to be used with heater, install blower assembly before putting unit in chosen location and connecting gas supply.

WARNING: Failure to position the parts in accordance with this diagram or failure to use only parts specifically approved may result in improper functions or property damage or personal injury.

CAUTION: The Blower Assembly is equipped with a Power Cord. Make sure that the Power Cord does not get under Blower Assembly or become damaged while being installed.

WARNING: Electrical Grounding Instructions: This appliance is equipped with a three prong (grounding) plug for your protection against shock hazard and should be plugged directly into a properly grounded three-prong receptacle. **DO NOT** cut or remove the grounding from this plug.

CAUTION: Label all wires prior to disconnection when servicing controls. Wiring errors can cause improper and dangerous operation.

Verify proper operation after servicing.

If any of the original wire as supplied with the appliance must be replaced, it must be replaced with a wire of at least a 105°C temperature rating.

WARNING: Only New Buck Corporation approved blower assembly, part number MA CVF714, may be used with Vent Free Stove Series CVFB200(LP) or CVFB200(NAT) Townsend II only.

NOTE: Do not run power cord underneath heater or in walk way or heavy traffic areas.

BLOWER ASSEMBLY MODEL (MA CVF714)

1. Remove rear shield from top rear of unit before installing optional Blower Assembly (MA CVF714).
2. Remove Blower Assembly from carton. Remove all protective packaging applied to Blower Assembly for shipment.
3. Check all items for any shipping damage. If damaged, promptly inform dealer where you purchased the Blower Assembly.
4. From the rear of the Fire Box, align four (4) notches in Blower Assembly with (4) holes in rear of Fire Box. This will ensure centering of Blower Assembly on the Fire Box. Attach Blower Assembly to Fire Box using four (4) #8 x 1/2" self-piercing mounting screws provided. (See Figure 5).

VENT FREE STOVE SERIES MODEL CVFB200(LP) or CVFB200(NAT) TOWNSEND II ONLY.

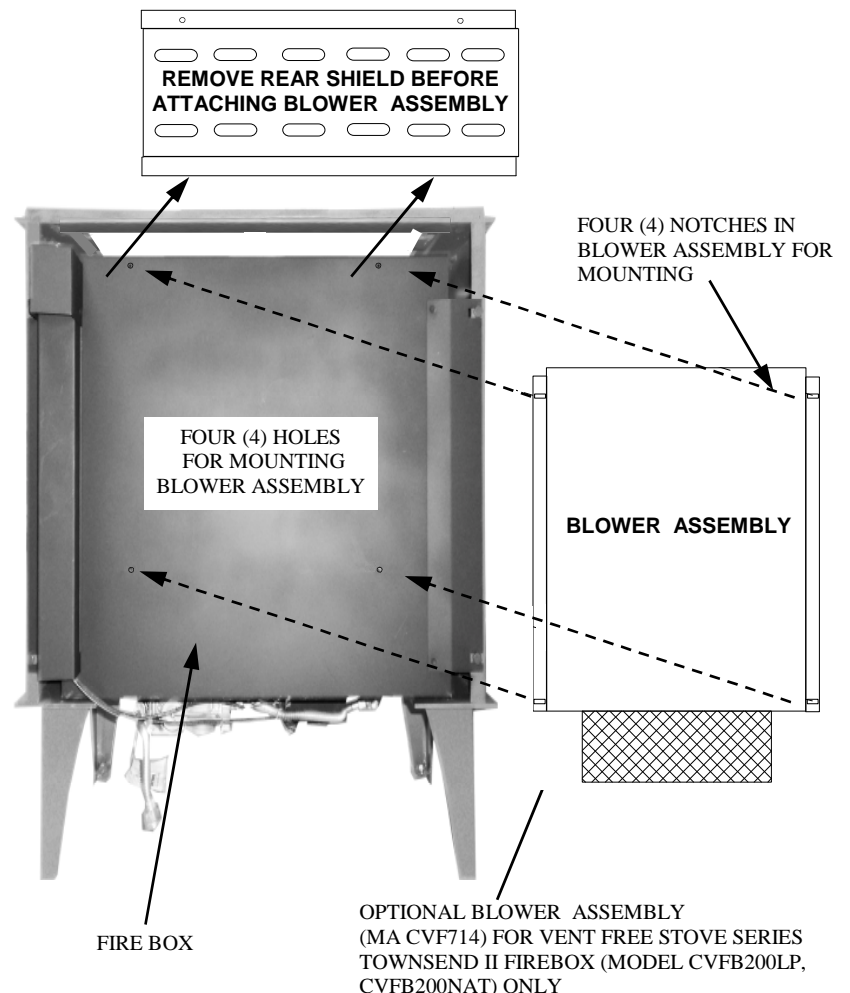

FIGURE 5 - LOCATION OF OPTIONAL BLOWER ASSEMBLY

INSTALLATION OF VENT FREE STOVE SERIES CFVB200, C100BA

NOTE:

Place freestanding stove in desired position in room. Be sure to maintain clearances to combustibles as outlined in Minimum Wall and Ceiling Clearances on this page.

***NOTICE:** This heater is intended for use as supplemental heat. Use this heater along with your primary heating system. Do not install this heater as your primary heat source. Do not run ceiling fan while heater is running. In the event of a power outage, you can use this heater as your primary heat source.

WARNING: A qualified service person must install heater. Follow all local codes.

WARNING: Never install the heater

- in a bedroom or bathroom
- in a recreational vehicle
- where curtains, furniture, clothing or other flammable objects are less than 48 inches from the front, top or sides of the heater
- in high traffic areas
- in windy or drafty areas

CAUTION: This heater creates warm air currents. These currents move heat to wall surfaces next to heater. Installing heater next to vinyl or cloth wall coverings or operating heater where impurities (such as tobacco smoke, aromatic candles, cleaning fluids, oil or kerosene lamps, etc.) in the air exist, may discolor walls.

IMPORTANT: Vent-free heaters add moisture to the air. Although this is beneficial, installing heater in rooms without enough ventilation air may cause mildew to form from too much moisture. See *Air for Combustion and Ventilation*, pages 4 through 5.

Maintain adequate clearances for accessibility for the purpose of servicing and proper operation.

GAS CONNECTION

Check gas type. Use only the type of gas indicated on the valve rating plate. If the type of gas listed on the plate is not your type of gas supply, **DO NOT INSTALL.** Contact your dealer for proper model.

Always use an external regulator for all LP heaters to reduce the supply tank pressure to a maximum of 13" W.C. This is in addition to the regulator furnished with the heater.

Warning: Connection directly to an unregulated LP tank can cause an explosion.

The normal gas connection is 3/8" NPT made at the right rear side facing stove. If a left side connection is desired, the connecting pipe may be routed under the rear of the burner base to terminate at the right hand side for connection to the inlet of the valve.

NOTE: The connecting pipe must be internally treated for protection from sulfur compounds if copper tubing is used for natural gas. Test for leaks using a solution of soap and water after completing the connection. **DO NOT USE OPEN FLAME.**

CLEARANCES TO COMBUSTIBLES (Vent-Free Operation Only)

WARNING: Maintain the minimum clearances. If you can, provide greater clearances from floor, ceiling and adjoining side and back walls.

Carefully follow these instructions. (See Figure 6). This stove is a freestanding unit designed to set directly on the floor. Do not place stove directly on carpeting, vinyl tile or any combustible material other than wood. The stove must set on a metal or wood panel extending the full width and depth of the appliance.

IMPORTANT: You must maintain minimum wall and ceiling clearances during installation. The minimum clearances are shown in Figure 6. Measure from outermost point of stove top.

Minimum Wall and Ceiling Clearances (See Figure 6)

- A. Clearances from outermost point of stove top to any combustible side wall should not be less than 4 inches.
- B. Clearances from outermost point of stove top to any combustible back wall should not be less than 4 inches (Includes Corner Installations).
- C. Clearances from the stove top to the ceiling should not be less than 48 inches.

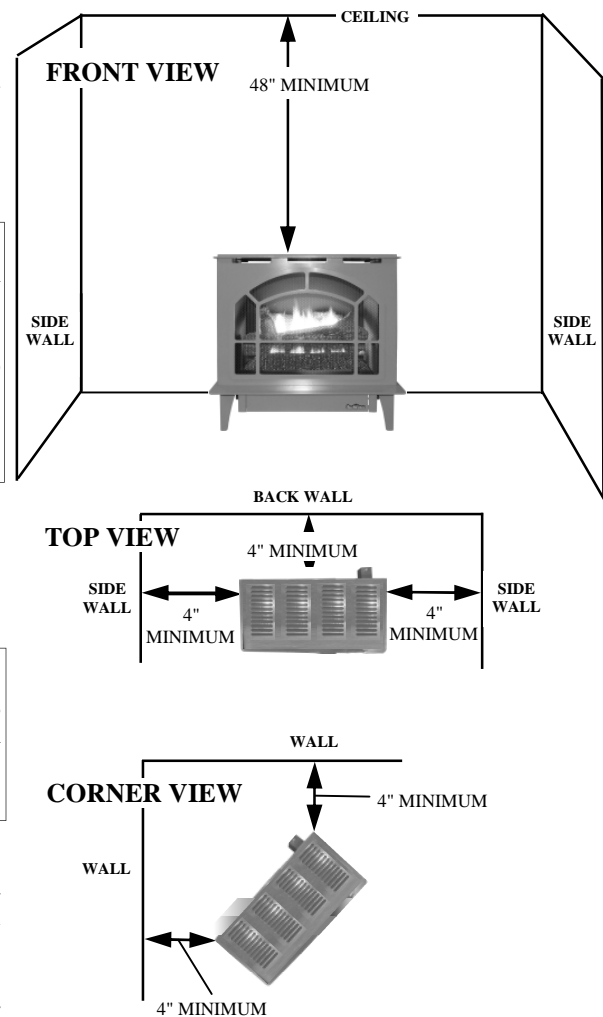

NOTE: TYPICAL STOVE CABINET MODEL
FIGURE 6 - MINIMUM CLEARANCES TO WALLS AND CEILING

INSTALLATION

Continued

After positioning stove in desired position, connect gas supply and complete all pressure checks. (See below *Connecting To Gas Supply*)

CONNECTING TO GAS SUPPLY

WARNING: This appliance is equipped with a 3/8" NPT (National Pipe Thread) inlet connection to the pressure regulator.

WARNING: A qualified service person must connect heater to gas supply. Follow all local codes.

Installation Items Needed

Before installing heater, make sure you have the items listed below:

- piping (check local codes)
- sealant (resistant to LP gas)
- equipment shutoff valve
- tests gauge connection
- sediment trap
- tee joint
- pipe wrench

A CSA/AGA design-certified equipment shutoff valve with 1/8" NPT tap is an acceptable alternative to test gauge connection. Purchase the optional CSA/AGA design-certified equipment shutoff valve from your dealer. See *Accessories*, page 23.

The gas inlet connection for the stove heater is located on the lower rear right-hand side when viewed from the front of the unit. Make sure gas log heater is secured to the stove cavity assembly.

WARNING: Never connect heater to private (non-utility) gas wells. This gas is commonly known as wellhead gas.

CAUTION: Use only new, black iron or steel pipe. Internally-tinned copper tubing may be used in certain areas. Check your local codes. Use pipe of 1/2" diameter or greater to allow proper gas volume to heater.

NOTE: TYPICAL STOVE CABINET MODEL

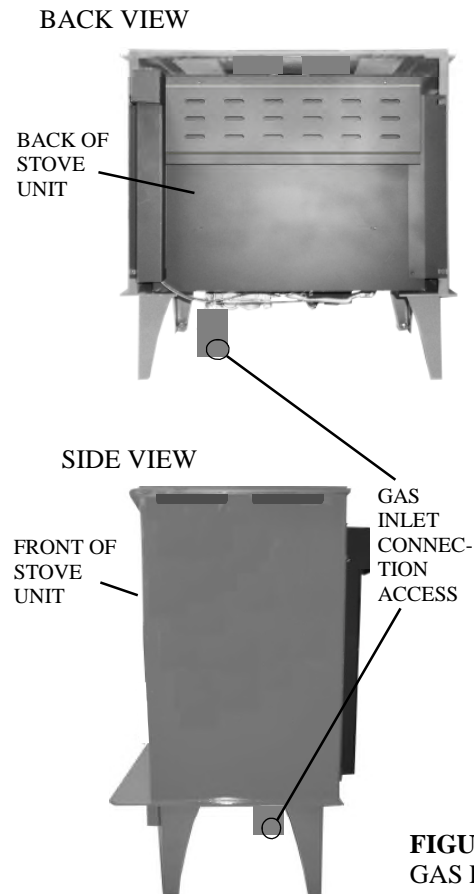

Installation must include an equipment shutoff valve, union and plugged 1/8" NPT tap. Locate NPT tap within reach for test gauge hook up. NPT tap must be upstream from heater (See Figure 8).

IMPORTANT: Install equipment shutoff valve in an accessible location. The equipment shutoff valve is for turning on or shutting off the gas to the appliance.

Apply pipe joint sealant lightly to male threads. This will prevent excess sealant from going into pipe. Excess sealant in pipe could result in clogged heater valves.

CAUTION: Use pipe joint sealant that is resistant to liquid petroleum (LP) gas.

FIGURE 7 - GAS REGULATOR LOCATION AND GAS LINE ACCESS INTO STOVE CABINET

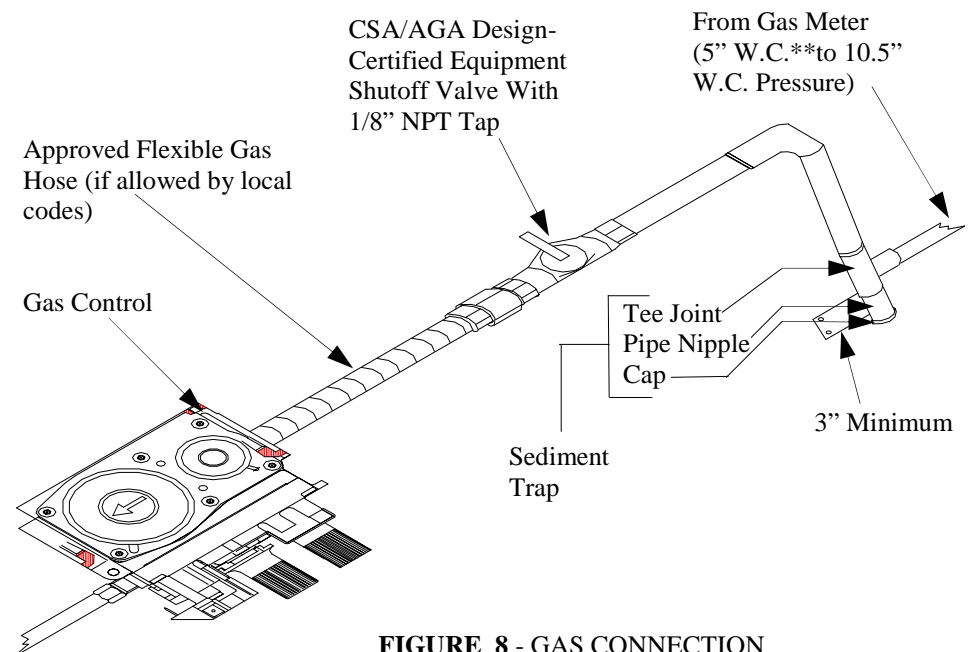

FIGURE 8 - GAS CONNECTION

INSTALLATION

Continued

We recommend that you install a sediment trap in supply line. Locate sediment trap where it is within reach for cleaning. Install in piping system between fuel supply and heater. Locate sediment trap where trapped matter is not likely to freeze. A sediment trap traps moisture and contaminants. This keeps them from going into heater controls. If sediment trap is not installed or is installed wrong, heater may not run properly.

CAUTION: Avoid damage to regulator. Hold gas regulator with wrench when connecting it to gas piping and/or fittings.

CHECKING GAS CONNECTIONS

WARNING: Test all gas piping and connections for leaks after installing or servicing. Correct all leaks at once.

WARNING: Never use an open flame to check for a leak. Apply a mixture of liquid soap and water to all joints. Bubbles forming show a leak. Correct all leaks at once.

Pressure Testing Gas Supply Piping System

Test Pressures In Excess of 1/2 psi (3.5 kPa)

1. Disconnect appliance with its appliance main gas valve (control valve) and equipment shutoff valve from gas supply piping system. Pressures in excess of 1/2 psi will damage heater regulator.
2. Cap off open end of gas pipe where equipment shutoff valve was connected.
3. Pressurize supply piping system by either using compressed air or opening main gas valve located on or near gas meter.

4. Check all joints of gas supply piping system. Apply mixture of liquid soap and water to gas joints. Bubbles forming show a leak.
5. Correct all leaks at once.
6. Reconnect heater and equipment shutoff valve to gas supply. Check reconnected fittings for leaks.

Test Pressures Equal To or Less Than 1/2 psi (3.5 kPa)

1. Close equipment shutoff valve (See Figure 9).
2. Pressurize supply piping system by either using compressed air or opening main gas valve located on or near gas meter.
3. Check all joints from gas meter to equipment shutoff valve (See Figure 10). Apply mixture of liquid soap and water to gas joints. Bubbles forming show a leak.
4. Correct all leaks at once.

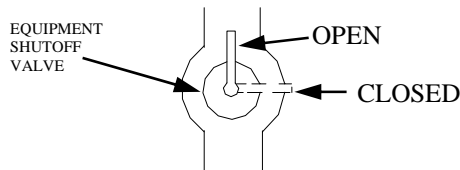

FIGURE 9 - EQUIPMENT SHUTOFF VALVE

Pressure Testing Heater Gas Connections

1. Open equipment shutoff valve (See Figure 9).
2. Open main gas valve located on or near gas meter.
3. Make sure control knob of heater is in the OFF position.
4. Check all joints from equipment shutoff valve to control valve (See Figure 10). Apply mixture of liquid soap and water to gas joints. Bubbles forming show a leak.
5. Correct all leaks at once.
6. Light heater (See *Operating Heater*, pages 17 through 19). Check all other internal joints for leaks.
7. Turn off heater (See *To Turn Off Gas to Appliance on pages 17 through 19*).

Input Rating	Minimum 22,400	Maximum 32,000
Type of Gas	LP/Propane	Natural
Manifold Pressure	<input type="checkbox"/> 10.0"wc	<input type="checkbox"/> 3.5"wc
*Min. Inlet	10.5"wc	4.5"wc
Max. Inlet	13.0"wc	10.5"wc

*For purpose of input adjustment.

The appliance must be isolated from the gas supply piping system by closing its equipment shutoff valve during any pressure testing of the gas supply piping system at test pressures equal to or less than 1/2 psi (3.5 kPa).

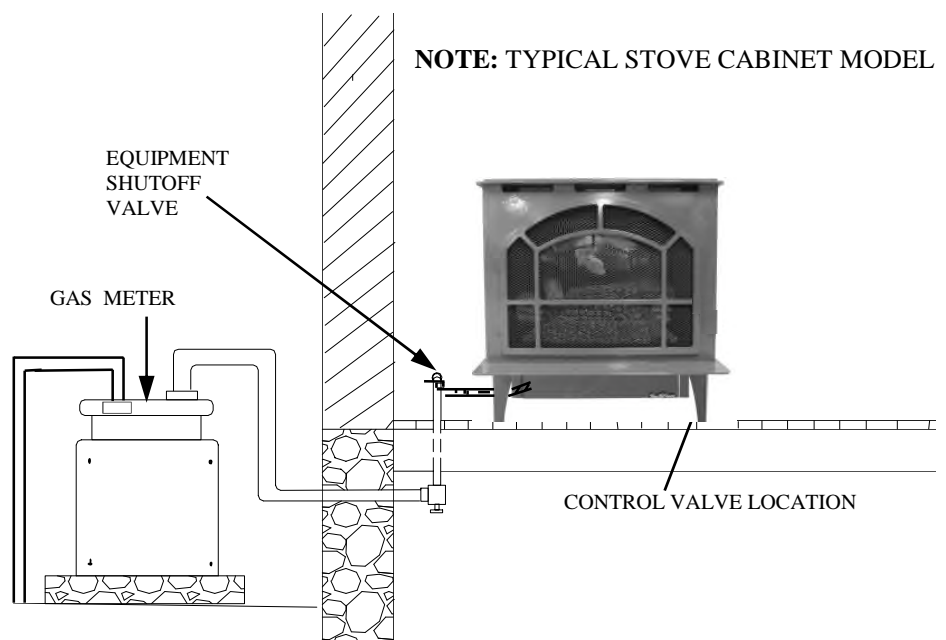

FIGURE 10 - CHECKING GAS JOINTS

INSTALLATION OF LOGS FOR TOWNSEND II MODEL CVFB200(LP) MODEL CVFB200(NAT)

**NOTE: FOR INSTALLATION
OF C100BA HEPPLWHITE
LOGS SEE PAGE 14.**

1. Remove log access door on top of unit by removing two (4) phillips screws. Set access door and screws aside. (See Figure 11).
2. Carefully insert logs through opening in top of unit as described on (Page 13, figure 13).
3. After placing logs on base, light heater making sure no logs are contacting flames, if so, then turn flame off. Reposition any log contacting flames so there is no contact with flame. Relight and check once more. If correct, turn flame off.
4. Place access door on top of unit and secure with the two (4) phillips screws.
5. Place the top grate on unit as shown. (See Figure 12).

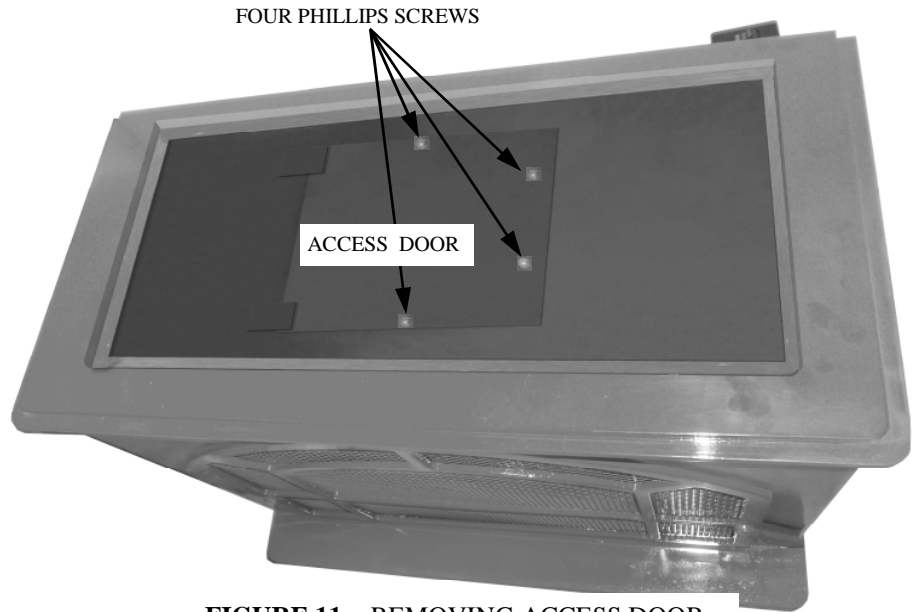

FIGURE 11 - REMOVING ACCESS DOOR

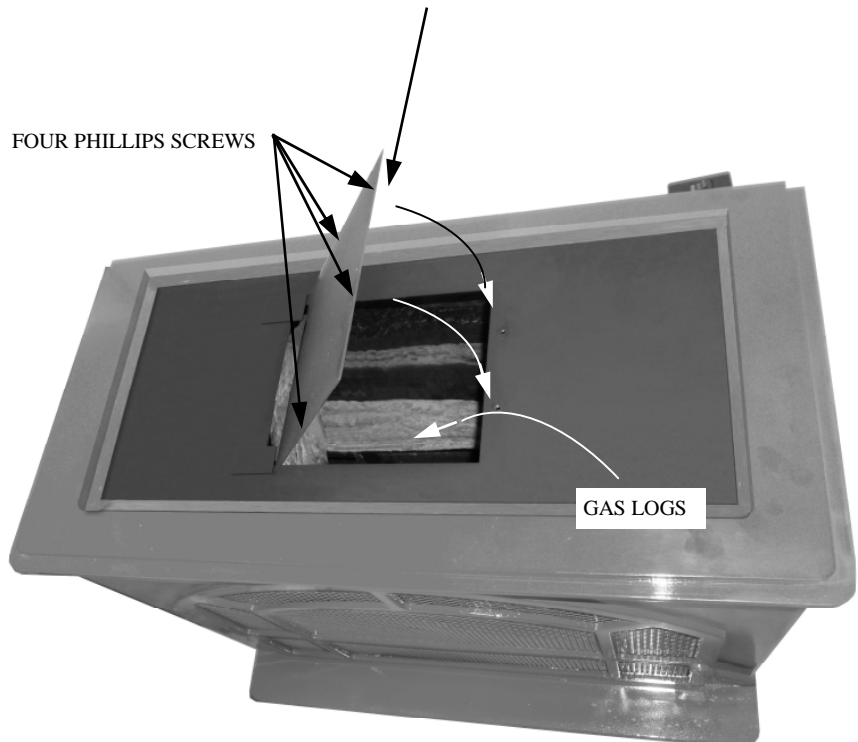
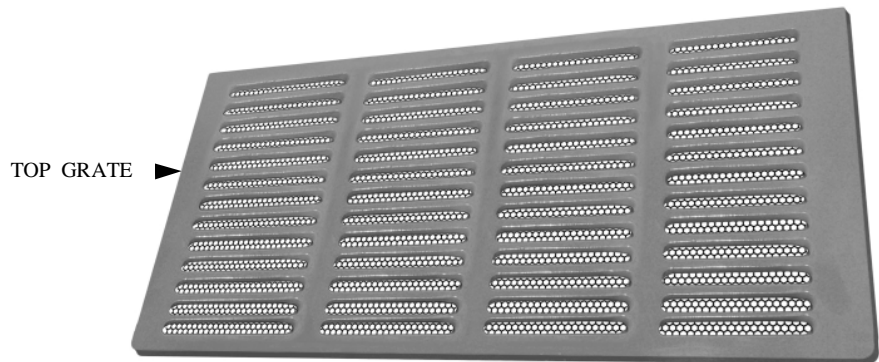

FIGURE 12 - REPLACING ACCESS DOOR AND INSTALL TOP GRATE

POSITIONING OF LOGS FOR VENT FREE STOVE SERIES CVFB200(LP), CVFB200(NAT) TOWNSEND II

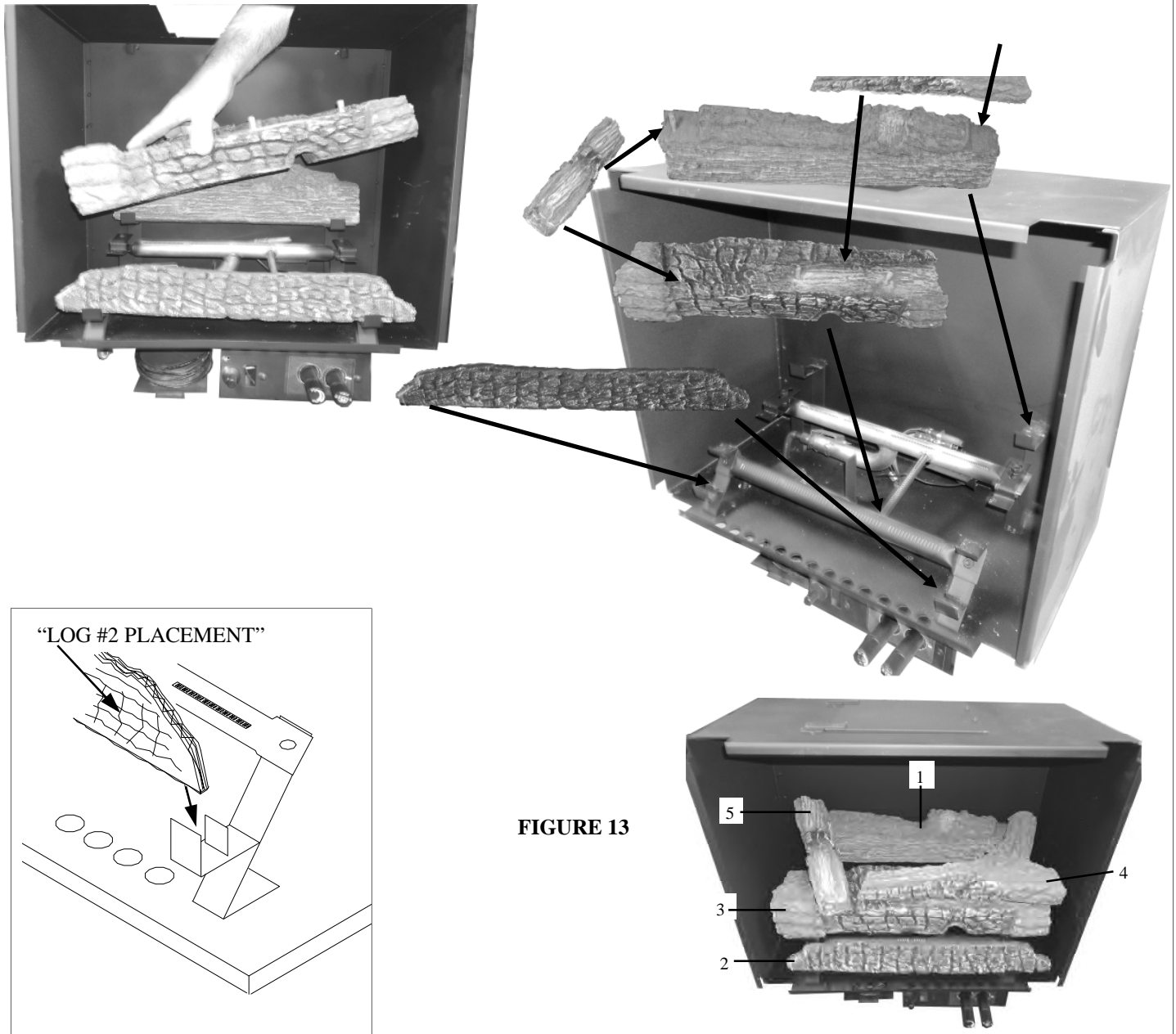

FIGURE 13

**WARNING: POSITIONING LOGS IS VERY CRITICAL (SEE FIGURE 13).
LOG PLACEMENT FOR LOG SET**

- 1) Place rear log (flat faced) #1 on rear log support. The log has alignment notches on each corner.
- 2) Place ember strip (wrapped in cardboard box) #2 on front log supports. Center from side to side.
- 3) Next place middle log (with ember burn out) #3 over front burner tube. The two ends are notched out on bottom to ensure proper fitting over ends of burner.
- 4) Right top log is a “y” shaped log #4. The round stem lays in the notched out space on the right corner of rear log. There is a pin on the middle log, and a hole on the flattened end of the top left log. Place hole over pin.
- 5) Place one end of the left top log #5 in notch of left corner on rear log and the other end of the left top log in notch on top middle log.

NOTE: When operated for the first time, the logs may emit a “paper burning” smell. This smell will gradually diminish and will be totally eliminated after the first few hours of operation.

INSTALLATION OF LOGS FOR HEPPLEWHITE MODEL C100BA(LP) MODEL C100BA(NAT)

1. Carefully insert logs through opening in top of unit, placing logs on base as described on (Page 15, figure 15).
2. After placing logs on base, light heater making sure no logs are contacting flames, if so, then turn flame off. Reposition any log contacting flames so there is no contact with flame. Relight and check once more. If correct, turn flame off.
3. Place the top grate on unit as shown. (See Figure 14).

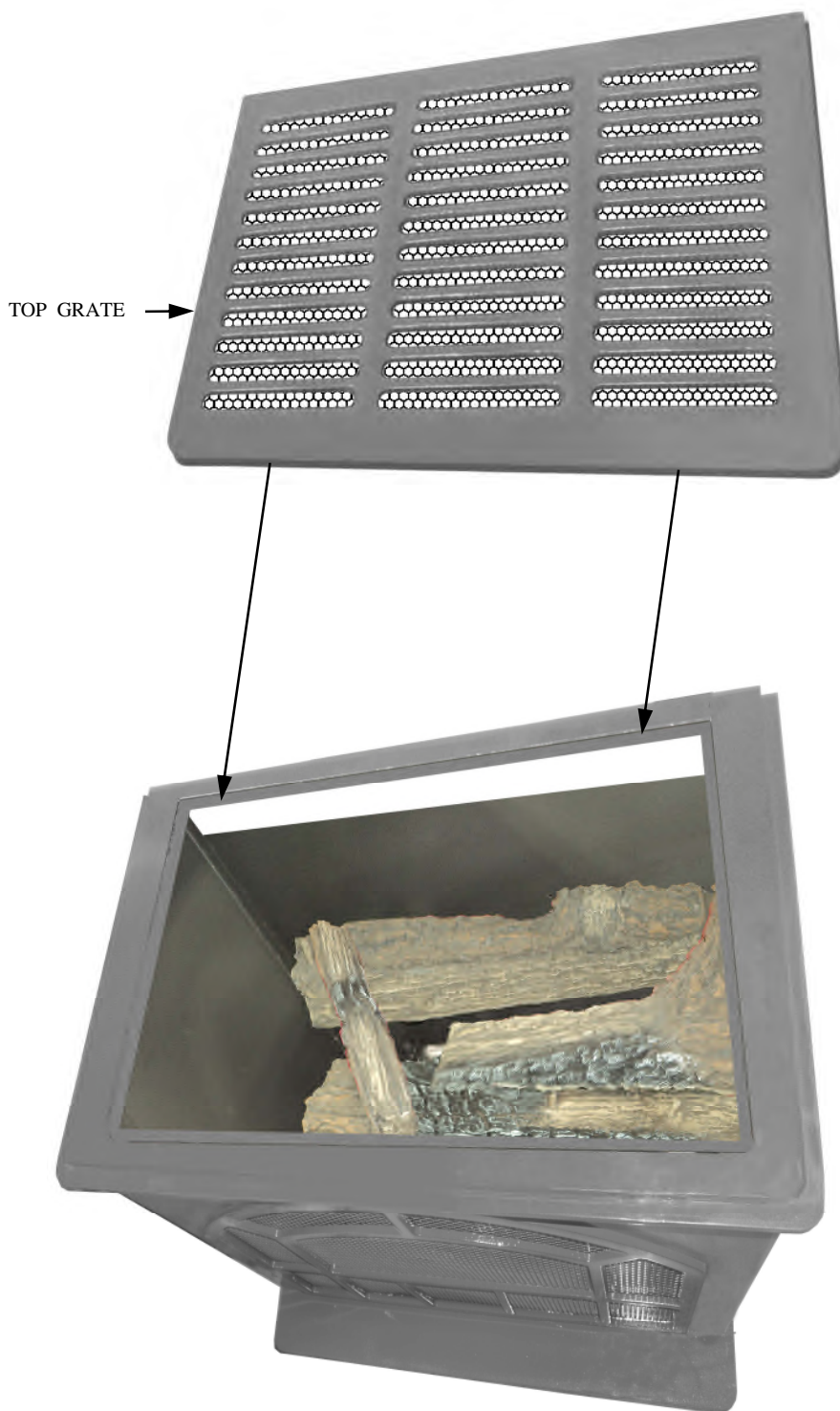

FIGURE 14 - INSTALL TOP GREAT

POSITIONING OF LOGS FOR VENT FREE STOVE SERIES C100BA(LP), C100BA(NAT) HEPPLEWHITE

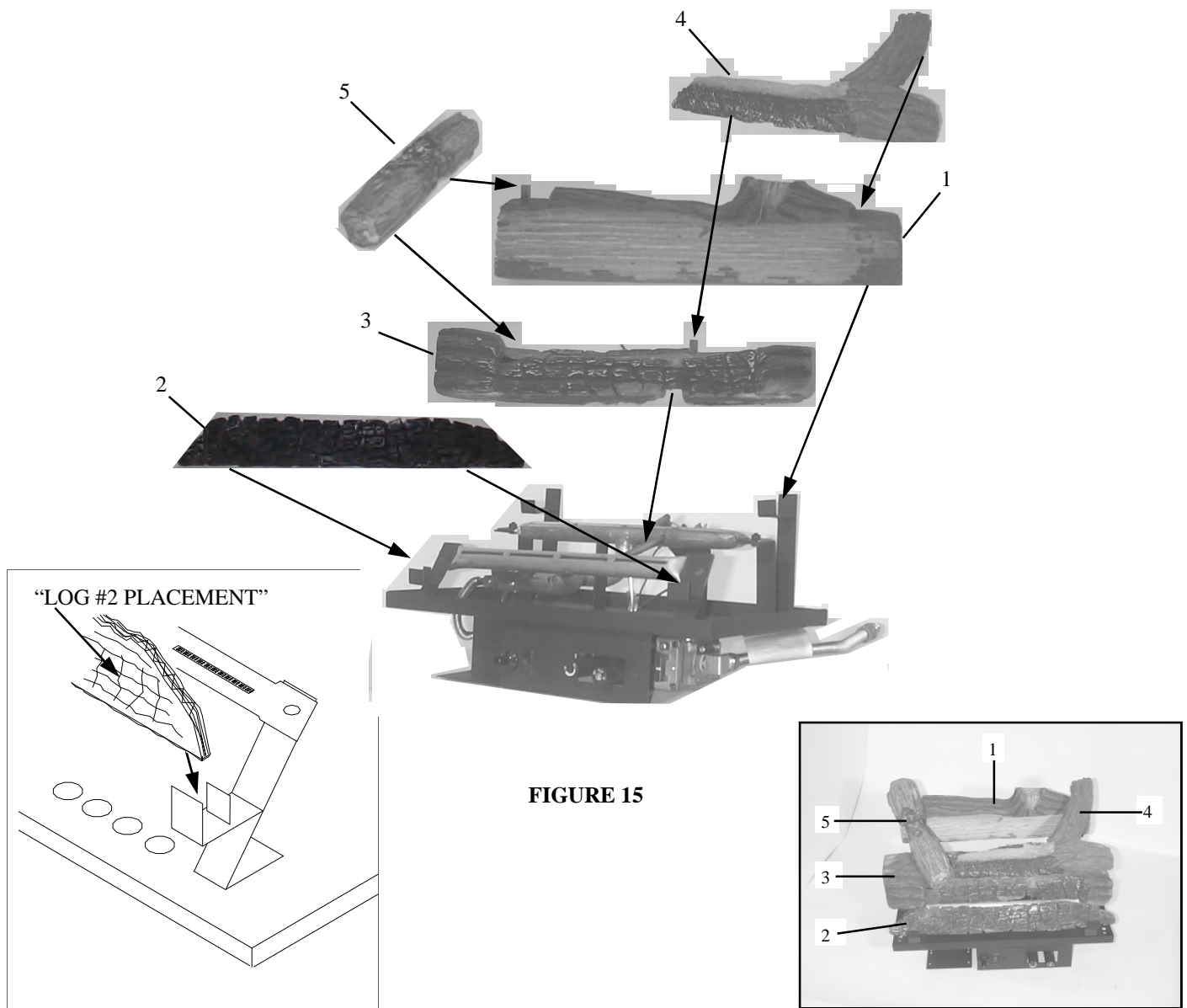

FIGURE 15

**WARNING: POSITIONING LOGS IS VERY CRITICAL (SEE FIGURE 15).
LOG PLACEMENT FOR LOG SET**

- 1) Place rear log (flat faced) #1 on rear log support. The log has alignment notches on each corner.
- 2) Place ember strip (wrapped in cardboard box) #2 on front log supports. Center from side to side.
- 3) Next place middle log (with ember burn out) #3 over front burner tube. The two ends are notched out on bottom to ensure proper fitting over ends of burner.
- 4) Right top log is a "y" shaped log #4. The round stem lays in the notched out space on the right corner of rear log. There is a pin on the middle log, and a hole on the flattened end of the top left log. Place hole over pin.
- 5) Place one end of the left top log #5 in notch of left corner on rear log and the other end of the left top log in notch on top middle log.

NOTE: When operated for the first time, the logs may emit a "paper burning" smell. This smell will gradually diminish and will be totally eliminated after the first few hours of operation.

OPERATING HEATER

FOR YOUR SAFETY READ BEFORE LIGHTING



WARNING: If you do not follow these instructions exactly, a fire or explosion may result causing property damage, personal injury or loss of life.

- A. This appliance has a pilot which must be lit by hand. When lighting the pilot, follow these instructions exactly. If piezo fails, then light the pilot using matches. Refer to *Manual Lighting Procedures*.
- B. **BEFORE OPERATING** smell all around the appliance area for gas. Be sure to smell next to the floor because some gas is heavier than air and will settle on the floor.

WHAT TO DO IF YOU SMELL GAS

- Do not try to light any appliance.
 - Do not touch any electric switch; do not use any phone in your building.
 - Immediately call your gas supplier from a neighbor's phone. Follow the gas supplier's instructions.
 - If you cannot reach your gas supplier, call the fire department.
- C. Use only your hand to push in or turn the gas control knob. Never use tools. If the knob will not push in or turn by hand, don't try to repair it, call a qualified service technician or gas supplier. Force or attempted repair may result in a fire or explosion.
 - D. Do not use this appliance if any part has been under water. Immediately call a qualified service technician to inspect the appliance and to replace any part of the control system and any gas control which has been under water.

LIGHTING INSTRUCTIONS SIT-MILLIVOLT VALVE

1. **STOP!** Read Safety Information.
2. Make sure manual shutoff valve is fully open. Set thermostat to lowest setting.
3. Turn off all electrical power to the appliance (if applies).
4. Turn control knob clockwise  to the "OFF" position.
5. Wait (5) five minutes to clear out any gas. Then smell for gas, including near the floor. If you smell gas, **STOP** and follow "B" in the safety information! If you don't smell gas, go to the next step.
6. Turn control knob counterclockwise  to the "PILOT" position. Press in control knob for (15) fifteen seconds.

NOTE: You may be running this heater for the first time after hooking up the gas supply. If so, the control knob may need to be pressed in for (30) thirty seconds. This will allow air to bleed from the gas system.

7. With control knob pressed in, push down and release ignitor button. This will light the pilot. If needed, keep repeating this step until pilot lights. Pilot is located between middle and rear logs. If pilot does not light with piezo, light by hand with a match.
8. Keep control knob pressed in for (1) one minute after lighting pilot. After (1) one minute, release control knob.

*Please refer to page 25 for location and picture of pilot.

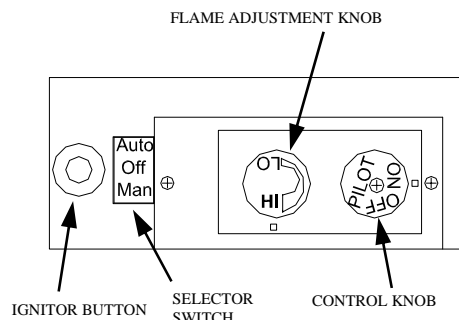



FIGURE 16 - CONTROL KNOB AND IGNITOR BUTTON LOCATION

*If knob does not pop up when released, stop and immediately call your service technician or gas supplier.
* If the pilot will not stay lit after several tries, turn the gas control knob to the "OFF" position and call your service technician or gas supplier.

NOTE: If pilot goes out, repeat steps 4 through 8. Wait (5) five minutes before attempting to light pilot again.

9. Turn control knob counterclockwise  to "ON" position.
10. If using unit without wall thermostat place "AUTO/OFF/MANUAL" switch into the manual position. If using wall thermostat place "AUTO/OFF/MANUAL" switch into the auto position and place thermostat to a setting higher than the room temperature.
11. Turn all electrical power on to the appliance (if applies).
12. Your heater is equipped with a "HI/LO" control. Turn clockwise for Low and counterclockwise for High.

TO TURN OFF GAS TO APPLIANCE SHUTTING OFF UNIT

1. Turn control knob clockwise  to the "OFF" position.
2. Turn off all electric power to the appliance if service is to be performed.

SHUTTING OFF BURNER ONLY (Pilot stays lit.)

1. Turn control knob clockwise  to the "PILOT" position.

CAUTION

Hot while in operation. Do Not Touch. Keep children, clothing, furniture, gasoline, and other liquids having flammable vapors away.

CAUTION

DO NOT TRY TO ADJUST HEATING LEVELS BY USING THE MANUAL SHUTOFF VALVE.

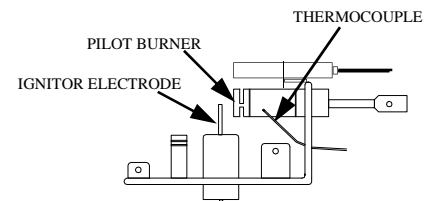

FIGURE 17 - O.D.S. PILOT ASSEMBLY SHOWN AS L.P. GAS.

OPERATING HEATER

Continued

WARNING: Improper installation, adjustment, alteration, service or maintenance can cause property damage, personal injury or loss of life. Installation and service must be performed by a qualified installer, service agency or the gas supplier.

IMPROPER: Always operate the appliance at the completely “ON” or the completely “OFF” positions. Never use the heater at a setting between these positions as this can result in improper combustion and excessive carbon monoxide emissions.

Keep burner and control compartment clean.

MANUAL LIGHTING PROCEDURE

1. Follow steps 1 through 5 under *Lighting Instructions*, page 16.
2. Depress control knob and light pilot with match and lighter rod.
3. Keep control knob pressed in for 30 seconds after lighting pilot. After 30 seconds, release control knob. Now follow steps 8 through 11, page 16.

OPTIONAL REMOTE CONTROL

NOTE: All remote control accessories must be purchased separately (see *Accessories*). Follow instructions included with the remote control.

NOTICE: You must light the pilot before using the remote control unit. See *Lighting Instructions* on page 16.

PILOT FLAME PATTERN (MILLIVOLT)

Figure 18 shows a correct pilot flame pattern. Figure 19 shows an incorrect pilot flame pattern. The incorrect pilot flame is not heating the thermocouple. This will cause the thermocouple to cool. When the thermocouple cools, the heater will shut down.

If pilot flame pattern is incorrect, as shown in Figure 18:

- Turn heater off (see *To turn Off Gas to Appliance*, page 16)
- See *Troubleshooting*, pages 20 through 22.

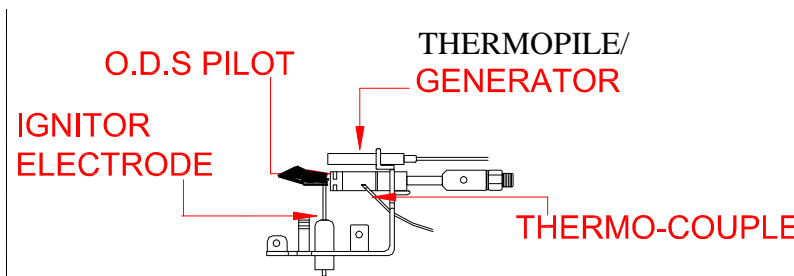

FIGURE 18 - CORRECT FLAME PATTERN L.P. OR NAT. GAS

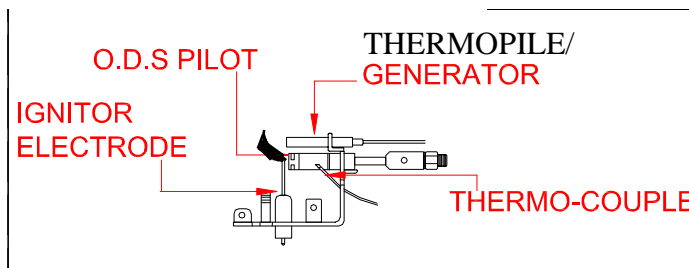
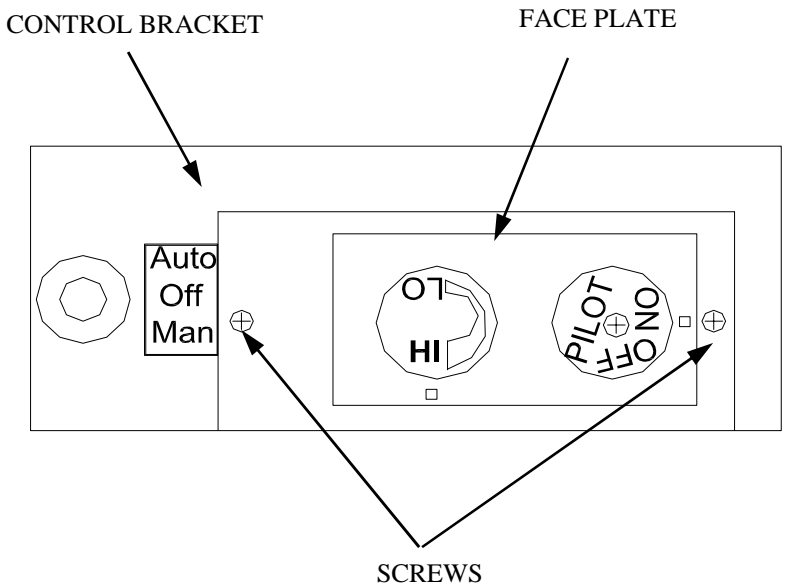

FIGURE 19 - INCORRECT PILOT FLAME PATTERN L.P. OR NAT. GAS

FRONT ACCESS TO (SIT) MILLIVOLT VALVE

When performing pressure checks or wiring accessories such as remote control or wall mounting thermostats it will be necessary to access the front of the valve body. (See Figure 20).

To access the front of the valve body, you must remove the face plate from the control bracket. To remove the face plate you will need to remove the two (2) Phillip head screws which attach it. After removing the screws, pull the face plate back from the unit. This will give you the access you need. When finished reattach the face plate to the control bracket with the screws you removed before operating the unit.



(SIT) MILLIVOLT VALVE WITH FACE PLATE ON

CAUTION

If unit has been in operation, allow the unit time to cool before touching. Failure to do so may result in personal injury.

NOTE: To ensure proper connection of switch refer to pages 26 and 27. Make sure the proper wires are used for thermostat and remote control connections, if not installed correctly the unit will not operate.

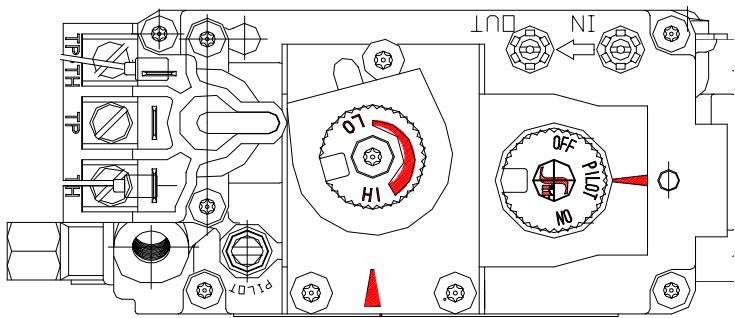

(SIT MILLIVOLT VALVE WITHOUT FACE PLATE)

FIGURE 20

INSPECTING AND CLEANING MAINTENANCE

WARNING: Turn off heater and let cool before cleaning.

CAUTION: You must keep control areas, burner and circulating air passageways of heater clean. Inspect these areas of heater before each use. Have heater inspected yearly by a qualified service person. Heater may need more frequent cleaning due to excessive lint from carpeting, pet hair and bedding material, etc.

CLEANING BURNER INJECTOR HOLDER AND PILOT AIR INLET HOLE

The air shutter slots allow the proper amount of air to mix with the gas. This provides a clean burning flame. Keep these slots clear of dust, dirt, lint and pet hair. Clean these air inlet slots prior to each heating season. Blocked air slots will create soot. We recommend that you clean the unit every three months during operation and have heater inspected yearly by a qualified service person.

We also recommend that you keep the burner tube and pilot assembly clean and free of dust and dirt. To clean these parts we recommend using compressed air no greater than 30 PSI. Your local computer store, hardware store or home center may carry compressed air in a can. You can use a vacuum cleaner in the blow position. If using compressed air in a can, please follow the directions on can. If you don't follow directions on can, you could damage the pilot assembly. **NOTE: For Townsend II** See (Figure 11, page 12). For **Hepplewhite** See (Figure 14, page 14). Removing access door and top grates of your stove will make cleaning easier.

1. Shut off unit, including pilot. Allow unit to cool for at least thirty minutes.
2. Inspect burner, pilot and slots in air shutter for dust and dirt.
3. Using Phillips head driver loosen set screw on air shutter and rotate shutter toward rear of unit. **NOTE:** Before rotating shutter mark the position of shutter so you can

move it back to the correct position after cleaning.

4. Opening the shutter as in step 3, allows you to inspect the orifice. After cleaning the area adjust air shutter to the original position.
5. Blow air through the slots and holes in the burner.
6. Blow air into the primary air holes on the injector holder.
7. In case any large clumps of dust have now been pushed into the burner repeat steps 3 and 4.

Clean the pilot assembly also. A yellow tip on the pilot flame indicates dust and dirt in the pilot assembly. There is a small pilot air inlet hole about two inches from where the pilot flame comes out of the pilot assembly (See Figure 22). With the unit off, lightly blow air through the air inlet hole. You may blow through a drinking straw if compressed air is not available.

LOGS

- If you remove logs for cleaning, refer to *Installing Gas Logs*. For **Townsend II** (Figure 13, page 13). For **Hepplewhite** (Figure 15, page 15), to properly replace logs.

MAIN BURNER

Periodically inspect all burner flame ports with the heater running. All slotted burner flame ports should be open with flame present. Some burner flame ports may become blocked by debris or rust, with no flame present. If so, turn off heater and let cool. Either remove blockage or replace burner. Blocked burner flame holes will create soot.

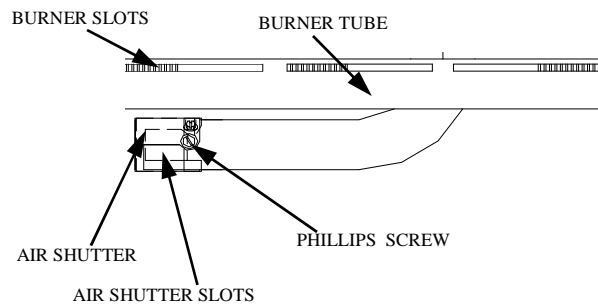

FIGURE 21 - BURNER/ AIR SHUTTER

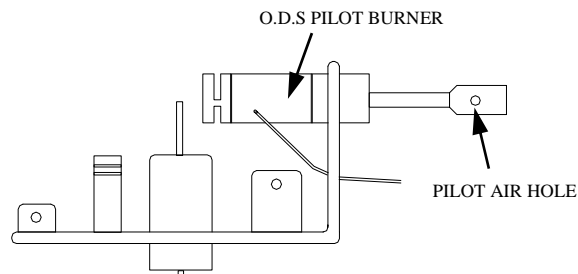

FIGURE 22 - PILOT ASSEMBLY

TROUBLESHOOTING

WARNING: Turn off heater and let cool before servicing. Only a qualified service person should service and repair heater.

CAUTION: Never use a wire, needle, or similar object to clean ODS/pilot. This can damage ODS/pilot unit.

NOTE: All troubleshooting items are listed in order of operation.

OBSERVED PROBLEM	POSSIBLE CAUSE	REMEDY
When ignitor button is pressed, there is no spark at ODS/pilot	<ol style="list-style-type: none"> Ignitor electrode not connected to ignitor cable Ignitor cable pinched or wet Broken ignitor cable Bad piezo ignitor Ignitor electrode broken Ignitor electrode positioned wrong 	<ol style="list-style-type: none"> Reconnect ignitor cable Free ignitor cable if pinched by any metal or tubing. Keep ignitor cable dry Replace ignitor cable Replace piezo ignitor Replace piezo ignitor Replace piezo ignitor
When ignitor button is pressed, there is spark at ODS/pilot but no ignition	<ol style="list-style-type: none"> Gas supply turned off or equipment shutoff valve closed Control knob not in PILOT position Control knob not pressed in while in PILOT position Air in gas lines when installed ODS/pilot is clogged Gas regulator setting is not correct 	<ol style="list-style-type: none"> Turn on gas supply or open equipment shutoff valve Turn control knob to PILOT position Press in control knob while in PILOT position Continue holding down control knob. Repeat igniting operation until air is removed Clean ODS/pilot (see <i>Cleaning and Maintenance</i>, page 19) or replace ODS/pilot assembly Replace gas control
ODS/pilot lights but flame goes out when control knob is released	<ol style="list-style-type: none"> Control knob not fully pressed in Control knob not pressed in long enough Equipment shutoff valve not fully open Pilot flame not touching thermocouple, which allows thermocouple to cool, causing pilot flame to go out. This problem could be caused by one or both of the following: <ol style="list-style-type: none"> Low gas pressure Dirty or partially clogged ODS/pilot Thermocouple connection loose at control valve Thermocouple damaged Control valve damaged 	<ol style="list-style-type: none"> Press in control knob fully After ODS/pilot lights, keep control knob pressed in 30 seconds Fully open equipment shutoff valve Contact local natural gas company <ul style="list-style-type: none"> Clean ODS/pilot (see <i>Cleaning and Maintenance</i>, page 19) or replace ODS/pilot assembly Hand tighten until snug, then tighten 1/4 turn more Replace thermocouple Replace control valve
Burner does not light after ODS/pilot is lit	<ol style="list-style-type: none"> Burner orifice clogged Inlet gas pressure is too low Burner orifice diameter is too small Thermopile/Generator leads disconnected or improperly connected Burners will not come on in remote position 	<ol style="list-style-type: none"> Clean burner (see <i>Cleaning and Maintenance</i>, page 19) or replace burner orifice Contact local gas company Replace burner orifice Reconnect leads Replace battery in transmitter and receiver

TROUBLESHOOTING

Continued

OBSERVED PROBLEM

	POSSIBLE CAUSE	REMEDY
Delayed ignition burner	<ol style="list-style-type: none">1. Manifold pressure is too low2. Burner orifice clogged	<ol style="list-style-type: none">1. Contact local gas company2. Clean burner (see <i>Cleaning and Maintenance</i>, page 19) or replace burner orifice
Burner backfiring during combustion	<ol style="list-style-type: none">1. Burner orifice is clogged or damaged2. Damaged burner3. Gas regulator defective	<ol style="list-style-type: none">1. Clean burner (see <i>Cleaning and Maintenance</i>, page 19) or replace burner orifices2. Replace damaged burner3. Replace gas control
Slight smoke or odor during initial operation	<ol style="list-style-type: none">1. Not enough air2. Gas regulator defective3. Residues from manufacturing processes and logs curing	<ol style="list-style-type: none">1. Check burner for dirt and debris. If found, clean burner (see <i>Cleaning and Maintenance</i>, page 19)2. Replace gas control3. Problem will stop after a few hours of operation
Moisture/condensation noticed on windows	<ol style="list-style-type: none">1. Not enough combustion/ventilation air	<ol style="list-style-type: none">1. Refer to <i>Air for Combustion and Ventilation</i> requirements (page 4)
Heater produces a whistling noise when burner is lit	<ol style="list-style-type: none">1. Turning control knob to HI position when burner is cold2. Air in gas line3. Air passageways on heater blocked4. Dirty or partially clogged burner orifice	<ol style="list-style-type: none">1. Turn control knob to LO position and let warm up for a minute.2. Operate burner until air is removed from line. Have gas line checked by local gas company3. Observe minimum installation clearances (see page 9)4. Clean burner (see <i>Cleaning and Maintenance</i>, page 19) or replace burner orifice
Dark residue on logs or inside of fireplace	<ol style="list-style-type: none">1. Improper log placement2. Drafts or other air currents affecting flame pattern3. Air holes at burner inlet blocked4. Burner flame holes blocked	<ol style="list-style-type: none">1. Properly locate logs (see <i>Installing Gas Logs</i>, for TOWNSENDII see page 13, for HEPPLWITE see page 13)2. Eliminate source of drafts around heater3. Clean out air holes at burner inlet. Periodically repeat as needed4. Remove blockage or replace burner
White powder residue forming within burner box or on adjacent walls or furniture	<ol style="list-style-type: none">1. When heated, vapors from furniture polish, wax, carpet cleaners, etc. turn into white powder residue	<ol style="list-style-type: none">1. Turn heater off when using furniture polish, wax, carpet cleaners or similar products

TROUBLESHOOTING

Continued

WARNING: If you smell gas
Shut off gas supply.
Do not try to light any appliance.
Do not touch any electrical switch; do not use any phone in your building.
Immediately call your gas supplier from a neighbor's phone.
Follow the gas supplier's instructions.
If you cannot reach your gas supplier, call the fire department.

IMPORTANT: Operating heater where impurities in air exist may create odors. Cleaning supplies, paint, paint remover, cigarette smoke, cements and glues, new carpet or textiles, etc., create fumes. These fumes may mix with combustion air and create odors. These odors will disappear over time.

OBSERVED PROBLEM	POSSIBLE CAUSE	REMEDY
Heater produces a clicking/ticking noise just after burner is lit or shut off	1. Metal expanding while heating or contracting while cooling	1. This is common with most heaters. If noise is excessive, contact qualified service person
Heater produces unwanted odors	1. Heater burning vapors from paint, hair spray, glues, cleaners chemicals, new carpet, etc. (see IMPORTANT statement above) 2. Gas leak. See WARNING statement at top of page	1. Open window and ventilate room. Stop using odor causing products while heater is running 2. Locate and correct all leaks (see <i>Checking Gas Connections</i> , page 11)
Heater shuts off in use (ODS operates)	1. Not enough fresh air is available 2. Low line pressure 3. ODS/pilot is partially clogged	1. Open window and/or door for ventilation 2. Contact local gas company 3. Clean ODS/pilot (see <i>Cleaning and Maintenance</i> , page 19)
Gas odor even when control knob is in OFF position	1. Gas leak. See WARNING statement at top of page 2. Control valve defective	1. Locate and correct all leaks (see <i>Checking Gas Connections</i> , page 10) 2. Replace control valve
Gas odor during combustion	1. Foreign matter between control valve and burner 2. Gas leak. See WARNING statement at top of page	1. Take apart gas tubing and remove foreign matter 2. Locate and correct all leaks (see <i>Checking Gas Connections</i> , page 10)

PARTS LIST
FOR MODELS CVFB200(LP), CVFB200(NAT) AND
C100BA(LP), C100BA(NAT)

MILLIVOLT (SIT)

KEY #	PART #	DESCRIPTION #
1	PE 8204C PE 8404C	PILOT ASSEMBLY NATURAL GAS PILOT ASSEMBLY L.P.
2	PO 10-2121-12	FLEXIBLE SUPPLY LINE
3	PE 820638 PE 820636	(SIT) MILLIVOLT VALVE NATURAL GAS (SIT) MILLIVOLT VALVE L.P.
4	PE 916188	ON/OFF KNOB EXTENSION
5	PE 916189	HI/LO KNOB EXTENSION
6	PE RC211RB	AUTO/OFF/MANUAL
7	PE 124461	PIEZO STRIKER
8	POT6-06	6" MANIFOLD SUPPLY LINE
8A	POT6-12	12" MANIFOLD SUPPLY LINE
9	PO H- BURN001	18" H-BURNER
10	PO 64MVORF PO 54MVORF PO 54MVORF PO 44MVORF	L.P. FRONT ORIFICE C100BA-CVFB200 L.P. REAR ORIFICE C100BA-CVFB200 NAT. FRONT ORIFICE C100BA-CVFB200 NAT. REAR ORIFICE C100BA-CVFB200

**REPLACEMENT PARTS
 OPTIONAL BLOWER ASSEMBLY (MA CVF714)
 FOR USE WITH CVFB200**

PART NO.	DESCRIPTION	QTY.
PH 101612TEK	#10-16 x 1/2" Self tapping Screws (For Mounting Blower Assembly To Fire Box)	4
PE A2-40-01WB	Motor	1
PE 400132	Therm o disc	1
PE 400240	Power Cord	1
PE 400320	Strain Relief	1
PE RA911VB	ON/OFF Switch	1

ACCESSORIES

Purchase these heater accessories from your local dealer. If they can not supply these accessories, call our Parts Department at 1-828-765-6144 for referral information. You can also write to the address listed on the back page of this manual.

RECEIVER AND HAND-HELD REMOTE CONTROL KIT PART# PO FDC-504

For remote-ready models. Allows the gas log heater to be turned on and off by using a hand-held remote control.

WALL THERMOSTAT PART# PE 400142

The desired comfort setting can be selected on the wall thermostat and the log heater will automatically cycle from pilot to the heat setting selected.

SERVICE HINTS

When Gas Pressure Is Too Low

- Pilot will not stay lit
- Burners will have delayed ignition
- Heater will not produce specified heat

When Gas Quality Is Bad

- Pilot will not stay lit
- Burners will produce flames and soot
- Heater will backfire when lit

You may feel your gas pressure is too low or gas quality is bad. If so, contact your local gas supplier.

REPLACEMENT PARTS

NOTE: Use only original replacement parts. This will protect your warranty coverage for parts replaced under warranty.

VENT FREE STOVE SERIES CVFB200(LP), CVFB200(NAT) TOWNSEND II WIRING DIAGRAM AND REMOTE OR WALL THERMOSTAT INSTALLATION

FACTORY WIRING

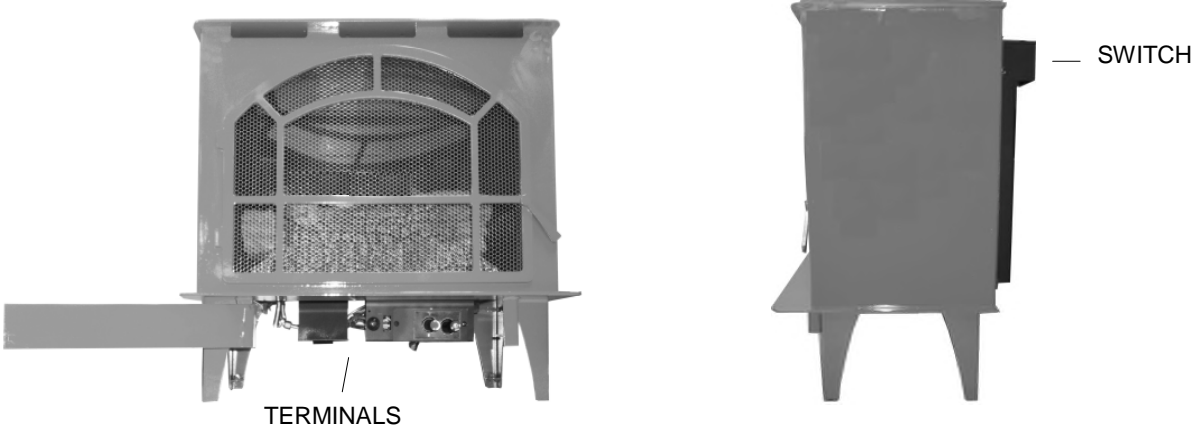
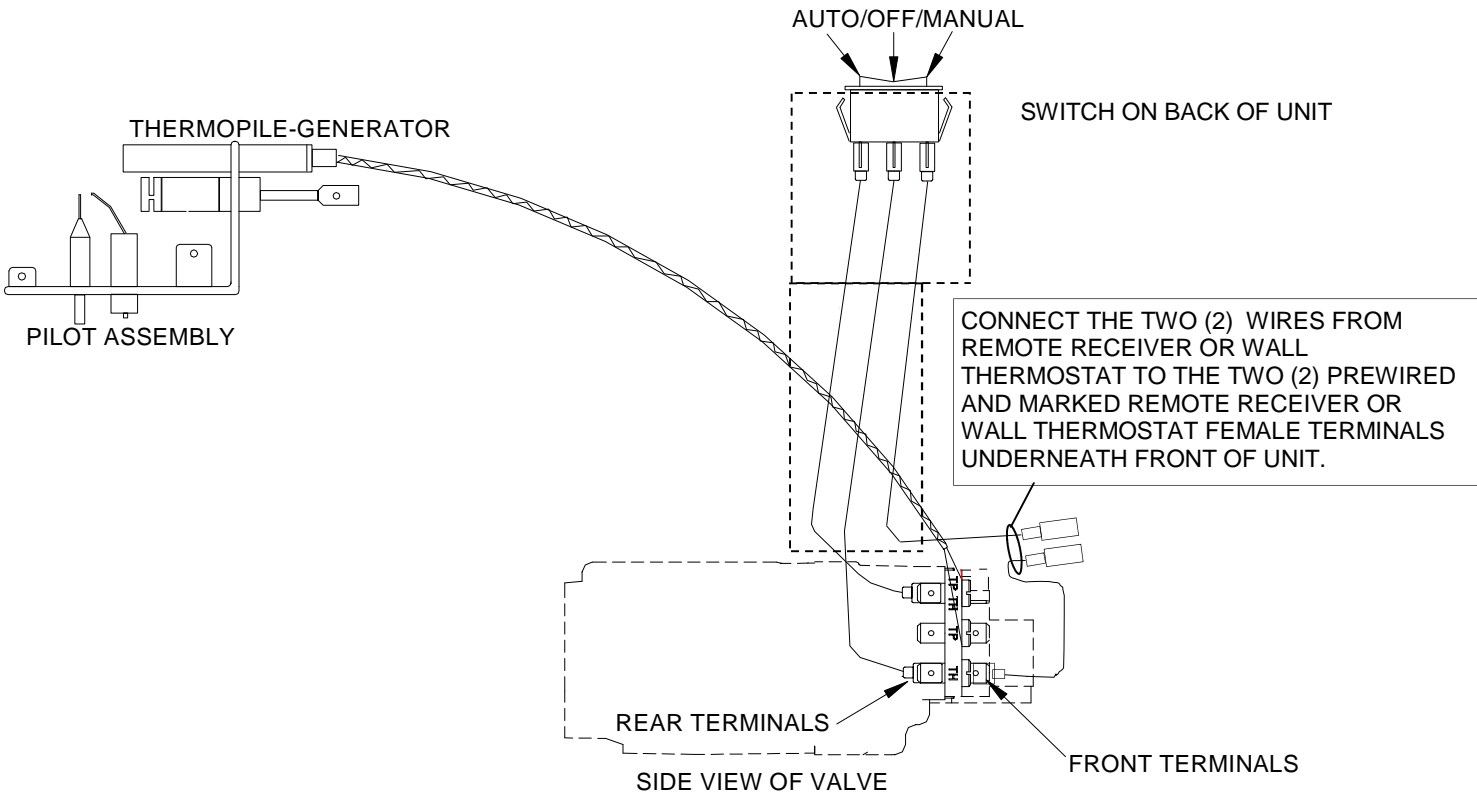

VENT FREE STOVE SERIES C100BA(LP), C100BA(NAT) HEPPLWHITE WIRING DIAGRAM AND REMOTE OR WALL THERMOSTAT INSTALLATION

FACTORY WIRING

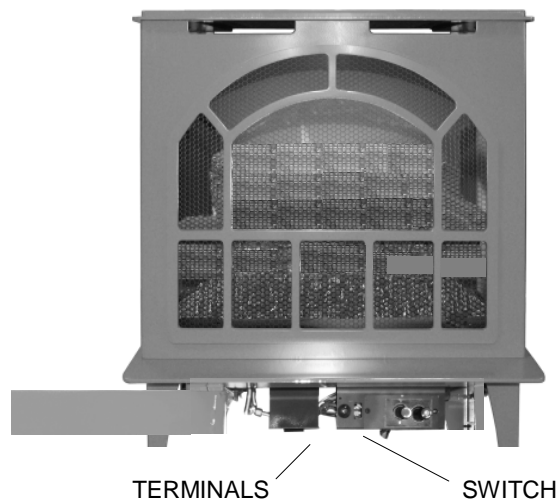
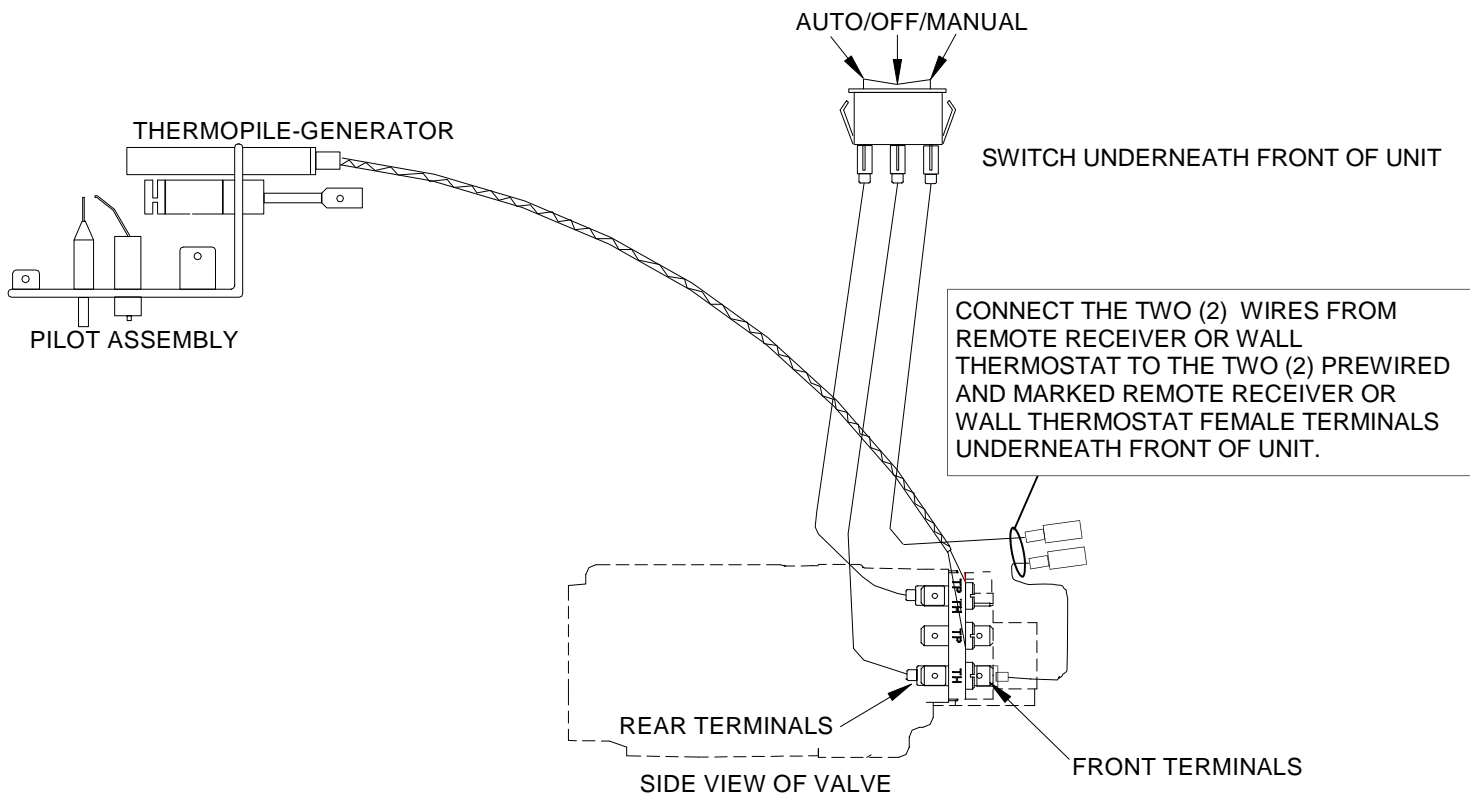

LIMITED WARRANTY VENT-FREE NATURAL OR L.P. (LIQUID PROPANE) GAS LOG HEATERS AND STOVE CHASSIS

WARRANTY INFORMATION

New Buck Corporation warrants this product to be free from defects in materials and components for two (2) year from the date of first purchase provided that the product has been properly installed, operated and maintained in accordance with all applicable instructions. To make a claim under this warranty the Bill of Sale or Cancelled check must be presented.

This warranty is extended only to the original retail purchaser. This warranty covers the cost of part(s) required to restore this heater to proper operating condition and an allowance for labor when provided by a New Buck Corp. dealer. Warranty part (s) MUST be obtained through authorized dealers of this product and / or New Buck Corp. who will provide original factory replacement parts. Failure to use original factory replacement parts voids this warranty. The heater MUST be installed by a qualified installer in accordance with all local codes and instructions furnished with the unit.

This warranty does not apply to parts that are not in original condition because of normal wear and tear, or parts that fail or become damaged as a result of misuse, accidents, lack of proper maintenance or defects caused by improper installation. Travel diagnostic cost, labor, transportation and any and all such other costs related to repairing a defective heater will be the responsibility of the owner.

For a period of one (1) year from the date of purchase, New Buck Corp. will replace or repair at its option: electrical motor, wiring, switches and optional accessories.

TO THE FULL EXTENT ALLOWED BY LAW OF THE JURISDICTION THAT GOVERNS THE SALE OF THE PRODUCT: THIS EXPRESS WARRANTY EXCLUDES ANY AND ALL OTHER EXPRESSED WARRANTIES AND LIMITS THE DURATION OF ANY AND ALL IMPLIED WARRANTIES, INCLUDING WARRANTIES OF MERCHANTABILITY AND FITNESS FOR A PARTICULAR PURPOSE TO TWO (2) YEARS ON ALL COMPONENTS FROM THE DATE OF PURCHASE: AND NEW BUCK CORPORATION LIABILITY IS HEREBY LIMITED TO THE PURCHASE PRICE OF THE PRODUCT AND NEW BUCK CORPORATION SHALL NOT BE LIABLE FOR ANY OTHER DAMAGES WHATSOEVER INCLUDING INDIRECT, INCIDENTAL OR CONSEQUENTIAL DAMAGES.

Some states do not allow a limitation on how long an implied warranty lasts or an exclusion or limitation of incidental or consequential damages, so the above limitation on implied warranties or exclusion or limitation on damages may not apply to you. This warranty gives you specific legal rights and you may also have other rights that vary from state to state.

For information about this warranty write: **NEW BUCK CORPORATION**
P.O. BOX 69
SPRUCE PINE, NC 28777

www.buckstovecorp.com

OWNER REGISTRATION

The attached owner registration card must be completed in its entirety and mailed within 30 days from date of installation in order for warranty coverage to begin to:

New Buck Corporation
P.O. Box 69
Spruce Pine, NC 28777

PLEASE NOTE: Owner Registration Card must contain Authorized Buck Stove Dealer Number and Certified Installer's number (if applicable) for warranty coverage to begin.

<p>NAME: _____</p> <p>ADDRESS: _____</p> <p>CITY: _____</p> <p>STATE: _____ ZIP: _____</p> <p>CUSTOMER EMAIL: _____</p> <p>MODEL #: _____</p> <p>SERIAL #: _____</p> <p>DATE OF PURCHASE: _____</p> <p>DATE OF INSTALLATION: _____</p> <p>INSTALLER'S NAME: _____</p> <p>PURCHASED FROM: _____</p>
--