

**MODEL 34 CONTEMPORARY**  
**MAY BE INSTALLED IN A SOLID FUEL BURNING FIREPLACE, AS A ZERO**  
**CLEARANCE FIREPLACE OR WITH AN OPTIONAL SURROUND.**



**WARNING:** If the information in this manual is not followed exactly, a fire or explosion may result causing property damage, personal injury or loss of life.

- Do not store or use gasoline or other flammable vapors and liquids in vicinity of this or any other appliance.

**WHAT TO DO IF YOU SMELL GAS:**

- Do not try to light any appliance.
- Do not touch any electrical switch; do not use any phone in your building.
- Immediately call your gas supplier from a neighbor's phone. Follow gas supplier's instructions.
- If you cannot reach your gas supplier, call fire department.
- Installation and service must be performed by a qualified installer, service agency or gas supplier.

This is an unvented gas-fired heater. It uses air (oxygen) from room in which it is installed. Provisions for adequate combustion and ventilation air must be provided. Refer to section "Producing Adequate Air For Combustion And Ventilation" page 29.

This appliance may be installed in an aftermarket, permanently located, manufactured (mobile) home, where not prohibited by local codes.

This appliance is only for use with type of gas indicated on rating plate. This appliance is not convertible for use with other gases.

**INSTALLER:** Leave this manual with appliance.  
**CONSUMER:** Retain this manual for future reference.

**MANUFACTURED BY:**  
**NEW BUCK CORPORATION**  
**200 ETHAN ALLEN DRIVE**  
**PO BOX 69**  
**SPRUCE PINE, N.C. 28777**  
[www.buckstove.com](http://www.buckstove.com)

**This appliance is intended for supplemental heating.**

Revised October 2019

# TABLE OF CONTENTS MODEL 34 CONTEMPORARY

SECTION I: Safety Information .....	3-5
SECTION II: Fireplace Preparation/Solid Fuel Burning Fireplace (FP) .....	6
Fireplace Clearances(FP) .....	7
Gas Connection .....	7
Placement of Logs.....	8
Gas Pressure Check.....	9
Operating / Lighting Instructions - SIT Millivolt Valve.....	10-13
Flame Check.....	14
SECTION III: Solid Fuel Burning Fireplace Installation (FP) .....	15
SECTION IV: Wooden Surround Installation (WS) .....	17
SECTION V: Zero Clearance (ZC).....	19
SECTION VI: Installation-After Market Permanently Located Manufactured Home .....	23
SECTION VII: Producing Adequate Air For Combustion And Ventilation .....	24
Air For Combustion And Ventilation Inside Building.....	26
Air For Combustion And Ventilation Outdoors.....	27
Important Safeguards .....	28
Cleaning .....	28
Wiring Diagram .....	29
Warnings / Grounding - Blower Information .....	30
Maintenance .....	31
Trouble Shooting.....	32-35
Service and Repair Parts .....	36
Replacement Parts .....	37-38
Warranty/Owner Registration .....	39



## SECTION I

### SAFETY INFORMATION WARNINGS

**IMPORTANT: READ THIS OWNER'S MANUAL CAREFULLY AND COMPLETELY BEFORE TRYING TO ASSEMBLE, OPERATE, OR SERVICE APPLIANCE. IMPROPER USE OF THESE LOGS CAN CAUSE SERIOUS INJURY OR DEATH FROM BURNS, FIRE, EXPLOSION AND CARBON MONOXIDE POISONING.**

**NOTE: When burning any unit or appliance that combusts fuel for heat, such as coal, oil, wood or natural and (L.P.) liquid petroleum gas, we highly recommend use of smoke and carbon monoxide detectors in your home.**

Early signs of carbon monoxide poisoning resemble flu, with headaches, dizziness and/or nausea. If you have these signs, heater may not be working properly. **Get fresh air at once and have heater serviced.** Some people such as, pregnant women, persons with heart or lung disease, anemia, apnea, those under influence of alcohol and those at high altitudes-are more affected by carbon monoxide than others.

**CAUTION: Strong drafts, such as a ceiling fan placed directly in front of heater (pulling from either direction) may create sooting. Sooting will discolor walls.**

1. The installation must conform with local codes or in the absence of local codes, with *National Fuel Gas Code, ANSI Z223.1/NFPA54*.
2. **This appliance may be installed in an After-Market\* Permanently Located Manufactured Home, where not prohibited by state or local codes.**  
\* (After-Market: Completion of sale, not for purpose of resale from manufacturer.)

**This appliance is only for use with the type of gas indicated on rating plate.  
This appliance is not convertible for use with other gases.**

**NOTE:**See Section VII, "Producing Adequate Air For Combustion And Ventilation" page 29.

**IMPORTANT: VENT-FREE HEATERS ADD MOISTURE TO AIR. ALTHOUGH THIS IS BENEFICIAL, INSTALLING HEATER IN ROOMS WITHOUT ADEQUATE VENTILATION MAY CAUSE MILDEW TO FORM FROM TOO MUCH MOISTURE.**

3. Never install this heater:
  - In a recreational vehicle, bathroom, bedroom or any other sleeping quarters.
  - Where curtains, furniture, clothing or other flammable objects are less than 42" from front of heater
  - In high traffic or windy areas
4. Two models are available. One specific model for propane (LP) and one for natural gas. Use the correct type gas for your home. Do not convert from one gas type to another.

**NOTE:** This appliance complies with ANSI Z21.11.2-2019 Unvented Room Heater.

**WARNING: ANY CHANGE TO THIS HEATER OR ITS CONTROLS CAN BE DANGEROUS.**

5. If this heater is used with propane gas, do not place propane supply tank(s) inside any structure.
6. **What To Do IF You Smell Gas:**  
Shut off gas supply.
  - Do not try to light any appliance.
  - Do not touch any electrical switch; do not use any phone in your building.
  - Immediately call your gas supplier from a neighbor's phone. Follow gas supplier's instructions.
  - If you cannot reach your gas supplier, call fire department.
7. When operated for first time, logs may emit a "paper burning" smell. This smell will gradually diminish and will be totally eliminated after first few hours of operation. Do not use blower at this time.
8. This heater shall not be installed in unusually tight construction unless provisions are provided adequate combustion and ventilation air. *See "Producing Adequate Air For Combustion And Ventilation," page 29.*
9. Surface of gas logs become very hot when operating. Keep children and adults away from hot surface. Gas logs will remain hot for sometime after shutdown. Allow surface to cool before touching.
10. Do not place clothing or other flammable material on or near appliance.
11. If equipped, fresh air damper must be closed.
12. Keep appliance area clean and free from combustible materials, gasoline and other flammable vapors and liquids.
13. If burner shuts off, do not relight until you provide fresh outside air. If burner continues to shut off, have unit serviced.
14. Do not use this heater if any part has been under water. Immediately call a qualified service technician to inspect room heater and to replace any part of control system and any gas control which has been under water.
15. Turn off heater and let cool before servicing.
16. These logs are made of bonded fiber. When removing logs and base, do not damage the bonded material. If material is damaged extensively, loose fiber dust could be emitted into air.
17. Any safety screen or guard removed for servicing an appliance must be replaced prior to operating heater.
18. This appliance is intended for supplemental heating.
19. **WARNING:** Any change to this heater or its controls can be dangerous.
20. Installation and repairs should be performed by a qualified service person. The appliance should be inspected before use and at least annually by a professional service person. More frequent cleaning may be required due to excessive lint from carpeting, bedding material, etc. It is imperative that control compartments, burners and circulating air passageways be kept clean.

21. All heater screens must be kept closed when operating gas logs.
22. **WARNING: Failure to keep primary air opening (s) of the burner (s) clean may result in soot and property damage.**
23. Do not use this heater for burning trash or cooking. Never place matches, paper, garbage or any other material on top of logs or into the flames.
24. Do not install or operate this heater in areas where impurities in air exist (such as tobacco smoke or heavy cooking grease). Particles from impurities may discolor walls.
25. Due to high temperatures, appliance should be located out of traffic and away from furniture and draperies.
26. Children and adults should be alerted to hazards of high surface temperature and should stay away to avoid burns or clothing ignition.
27. Young children should be carefully supervised when they are in same room with appliance.
28. An unvented room heater, having an input rating of more than 10,000 Btu per hour, shall not be installed in a bedroom or bathroom.
29. The appliance and its main gas valve must be disconnected from gas supply piping system during any pressure testing of that system at test pressure in excess of 1/2 psi (3.5 kPa).
30. The appliance must be isolated from gas supply piping system by closing its equipment shut-off valve during any pressure testing of gas supply piping system at test pressures equal to or less than 1/2 psi (3.5 kPa).
31. **WARNING:** Do not allow fans to blow directly into fireplace. Avoid any drafts that alter burner flame patterns.
32. **WARNING:** Do not use a blower insert, heat exchanger insert or other accessory not approved for use with this heater.
33. A fireplace screen must be in place when appliance is operating and unless other provisions for combustion air are provided, screen shall have an opening (s) for introduction of combustion air.

## SECTION II

### FIREPLACE PREPARATION

The fireplace needs to be prepared before installing heater.

A. Turn off the gas supply to fireplace.

**WARNING:** BEFORE INSTALLING IN A SOLID-FUEL BURNING FIREPLACE, CHIMNEY FLUE AND FIREBOX MUST BE CLEANED OF SOOT, CREOSOTE, ASHES AND LOOSE PAINT BY A QUALIFIED CHIMNEY CLEANER.

**WARNING:** DO NOT ALLOW FANS TO BLOW DIRECTLY INTO FIREPLACE. AVOID DRAFTS THAT ALTER BURNER FLAME PATTERNS.

**WARNING:** DO NOT USE A BLOWER INSERT, HEAT EXCHANGER INSERT OR OTHER ACCESSORIES NOT APPROVED FOR USE WITH THIS HEATER.

**WARNING:** ANY OUTSIDE AIR DUCTS AND/OR ASH DUMPS IN FIREPLACE SHALL BE PERMANENTLY CLOSED AT TIME OF APPLIANCE INSTALLATION.

B. Read the following sections before installing your unit; Section III, page 20 “Installation In A Solid-Fuel Burning Fireplace” and Section VIII, page 29 “Producing Adequate Air For Combustion And Ventilation.”

**WARNING:** CUTTING ANY SHEET-METAL PARTS OF SOLID-FUEL BURNING FIREPLACE OR LISTED VENTLESS FIREBOX ENCLOSURE IN WHICH UNVENTED FIREPLACE INSERT IS TO BE INSTALLED IS PROHIBITED.

**NOTE:** IF FACTORY BUILT FIREPLACE HAS NO GAS ACCESS HOLE (S) PROVIDED, AN ACCESS HOLE OF 1.5 inch (37.5mm) DIAMETER OR LESS MAY BE DRILLED THROUGH LOWER SIDES OR BOTTOM OF FIREBOX. THIS ACCESS HOLE MUST BE PLUGGED WITH NON-COMBUSTIBLE INSULATION AFTER GAS SUPPLY LINE HAS BEEN INSTALLED. REFRACTORY, GLASS DOORS , SCREEN RAILS, SCREEN MESH AND SOLID-FUEL LOG GRATES (IF APPLICABLE) CAN BE REMOVED FROM FIREPLACE BEFORE INSTALLING UNVENTED FIREPLACE INSERT.

## INSTALLATION AND CLEARANCES

To ensure a safe installation into a masonry or factory built fireplace, instructions must be carefully followed:

(1) Sidewall Clearances:

Clearance from side of fireplace opening to any adjacent combustible wall should not be less than: right side 7", left side 7".

(2) Ceiling Clearances:

The ceiling height should not be less than 24" from top of fireplace opening.

(3) Mantel Clearances:

Clearances from top of heater to mantel or mantel supports should not be less than 20".

**NOTE:** See following sections for installation options: Section III page 15 "Installation In A Solid-Fuel Burning Fireplace" and Section IV page 17 "Installation With Optional Wooden Mantel" and Section V page 19 "Zero Clearance Installation."

**WARNING: ANY CHANGE TO THIS HEATER OR ITS CONTROLS CAN BE DANGEROUS.**

## GAS CONNECTION

Check gas type. Use only type of gas indicated on valve rating plate. If type of gas listed on plate is not your type of gas supply, **DO NOT INSTALL.** Contact your dealer for proper model.

Always use an external regulator for all LP heaters to reduce supply tank pressure to a maximum of 13" W.C. This is in addition to regulator furnished with heater.

**WARNING: CONNECTION DIRECTLY TO AN UNREGULATED LP TANK CAN CAUSE AN EXPLOSION.**

Normal gas connection is 3/8" N.P.T. made at left side of appliance (facing front of appliance). If a right side connection is desired, connecting pipe may be led under rear of burner base to terminate at right side for connection to inlet of valve.

**NOTE:** The connecting pipe must be internally tinned copper tubing for use with natural gas. Test for leaks using a solution of soap and water after completing the connection. **DO NOT USE OPEN FLAME.**

**WARNING: Installation and repairs should be performed by a qualified service person. Appliance should be inspected before use and at least annually by a professional service person. More frequent cleaning may be required due to excessive lint from carpeting, bedding material, etc. It is imperative that control compartments, burners and circulating air passageways of appliance be kept clean.**



## #POCRESBLG-E.S.B. LOG SET PLACEMENT FOR MODEL 34 CONTEMPORARY

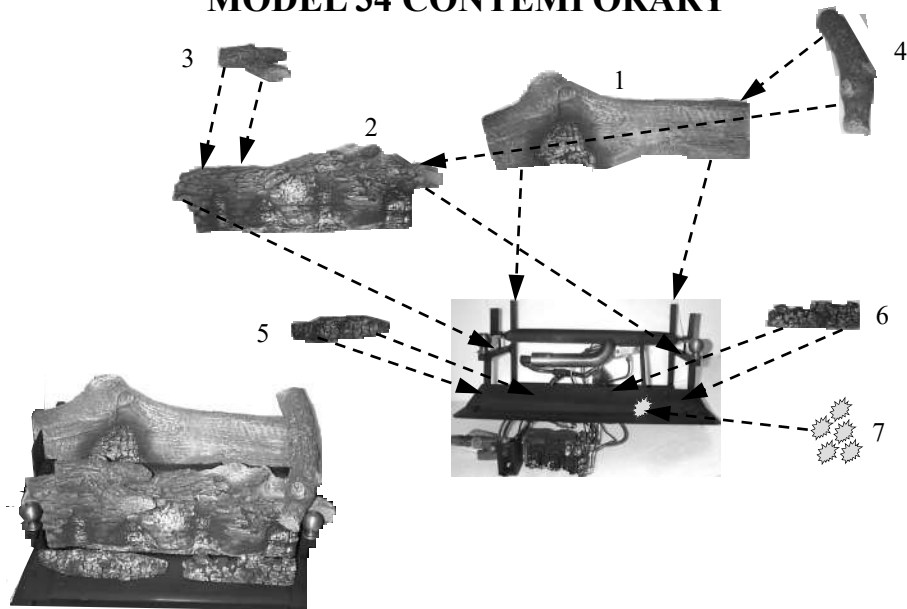

“MILLIVOLT ONLY”

**WARNING:** Failure to position parts in accordance with these diagrams or failure to use only parts specifically approved with this heater may result in property damage or personal injury.

**WARNING:** POSITIONING OF LOGS IS VERY CRITICAL (SEE DIAGRAM ABOVE).

MODEL E.S.B: (1) Rear Log, (2) Middle Log, (3) Left Top Middle Log, (4) Right Top Middle Log (5), Left Front Log (6), Right Front Log (7), Glowing Embers in front of 5 & 6 logs.

- 1) Place rear log #1 on rear log supports. The log has alignment notches on each rear corner.
- 2) Place Middle log #2 in front of rear burner tube and then move log forward. The log should sit just behind brass knob (s), located in middle section of base between rear burner tube and front burner pan.
- 3) Place Left Top Middle log #3 on pins located on left top section of Middle log #2.
- 4) Place Right Top Middle log #4 on pin located on right top section of Middle log #2 and align notch on right side #4 with side shield on right.
- 5) Place Left Front log #5 on locator pins located on left middle section of front burner pan.
- 6) Place Right Front log #6 on locator pins located on right middle section of front burner pan.
- 7) Provided with your log set is a package of Glowing Embers (rock wool). Open package and tear off small pieces of wool material and place it over small holes (ports) located on front burner pan in front of logs #5 and #6. Cover entire section of holes (ports).

**\*Replacement of loose (Glowing Embers) must be purchased from the original manufacturer and application of excess loose material may adversely affect performance of heater.**

**NOTE:** Wash your hands immediately after coming in contact with wool material. The wool can cause slight itching or burning. Avoid any contact with eyes.

**WARNING:** All previously applied loose material must be removed prior to replacement.

# GAS PRESSURE CHECK

Check inlet pressure to burner to ensure that it is as shown in table below. **NOTE:**The pressure check point is located on the right side of valve facing burner, for SIT Millivolt.

Appliance and its main gas valve must be disconnected from the gas supply piping system during any pressure testing of that system at test pressures in excess of 1/2 psi (3.5kPa).

Appliance must be isolated from gas supply piping system by closing its equipment shut-off valve during any pressure testing of gas supply piping system at test pressures equal to or less than 1/2 psi (3.5 kPa).

VALVE	(MILLIVOLT)	
MODEL:	FP34	FP34
<u>GAS TYPE</u>	<u>Natural</u>	<u>Propane</u>
Maximum Heat Input	33,000	33,000
Minimum Heat Input	23,000	23,000
<u>Gas Inlet Pressure</u>		
Maximum	10.5ins.W.C.	13ins.W.C.
Minimum	3.5.0ins.W.C.	8ins.W.C.
<u>Manifold Pressure</u>		
Maximum	3.5ins.W.C.	9.0ins.W.C.
Minimum	3.0ins.W.C.	8.2ins.W.C.

**NOTE:** On initial installation it may be necessary to bleed out air in the gas lines. Do this by holding the control knob and turning the knob to the “PILOT” position for about 30 seconds.

To check the regulator pressure, remove the pressure tag and plug at the left side of the regulator facing the heater. The pressure should be checked with the heater burning and the control set on high. After measuring the pressure, replace the pressure tap plug, ensuring that there are no leaks. **For the purpose of minimum input adjustment.**

## WARNING

**This appliance is equipped for (natural or propane) gas. Field conversion is not permitted.**

**Solid fuels shall not be burned in the same fireplace where an unvented room heater has been installed.**

**NOTE: The following label has been provided with this appliance and must be read and then attached to floor of the fireplace or firebox. The label is a peel and stick label. Make sure the area is clean before attaching label to it.**

## PEEL AND STICK LABEL

**WARNING: This solid-fuel burning fireplace or listed vent less enclosure has been converted for use with an unvented fireplace insert only. A solid-fuel burning fireplace cannot be used for burning wood or solid fuels unless all original parts have been replaced and fireplace re-approved by the authority having jurisdiction. A vent less firebox enclosure cannot be used with an unvented gas log unless all original parts have been replaced and vent less firebox enclosure re-approved by authority having jurisdiction.”**

## **OPERATING INSTRUCTIONS**

Before operating this appliance, proceed through following checklist.

1. Read and understand these instructions before operating this appliance.
2. Check that there are no gas leaks. If you smell gas do not attempt to light this appliance.
3. Verify that log placement is correct.

**WARNING: ANY CHANGE TO THIS HEATER OR ITS CONTROLS CAN BE DANGEROUS.**

## **LIGHTING INSTRUCTIONS**

### **SIT-MILLIVOLT VALVE**

### **FOR YOUR SAFETY READ BEFORE LIGHTING**

**WARNING: If you do not follow these instructions exactly, a fire or explosion may result causing property damage, personal injury or loss of life.**

- A. This appliance has a pilot which must be lit by hand. When lighting pilot follow these instructions exactly. If piezo fails, then light pilot using matches. Refer to match lighting instructions.
- B. **BEFORE LIGHTING** smell all around appliance area for gas. Be sure to smell next to floor because some gas is heavier than air and will settle to floor.

#### **WHAT TO DO IF YOU SMELL GAS:**

- \* Do not try to light any appliance.
  - \* Do not touch any electric switch, do not use any phone in your building.
  - \* Immediately call your gas supplier from a neighbor's phone. Follow gas supplier's instructions.
  - \* If you cannot reach your gas supplier, call fire department.
- C. Use only your hand to push in or turn gas knob. Never use tools. If knob will not push in or turn by hand, don't try to repair it. Call a qualified service technician. Forced or attempted repair may result in a fire or explosion.
  - D. Do not use this appliance if any or part of it has been under water. Immediately call a qualified service technician to inspect the appliance and to replace any part of the control system and any gas control which has been under water.

## LIGHTING INSTRUCTIONS

1. **STOP.** Read the safety information on (page 10).
2. Make sure manual shutoff valve is fully closed. If equipped with thermostat, set to lowest setting.
3. Turn off all electrical power to appliance.
4. Open access door located at bottom of front of appliance.
5. Push in gas control knob slightly and turn clockwise  to full “OFF” position.

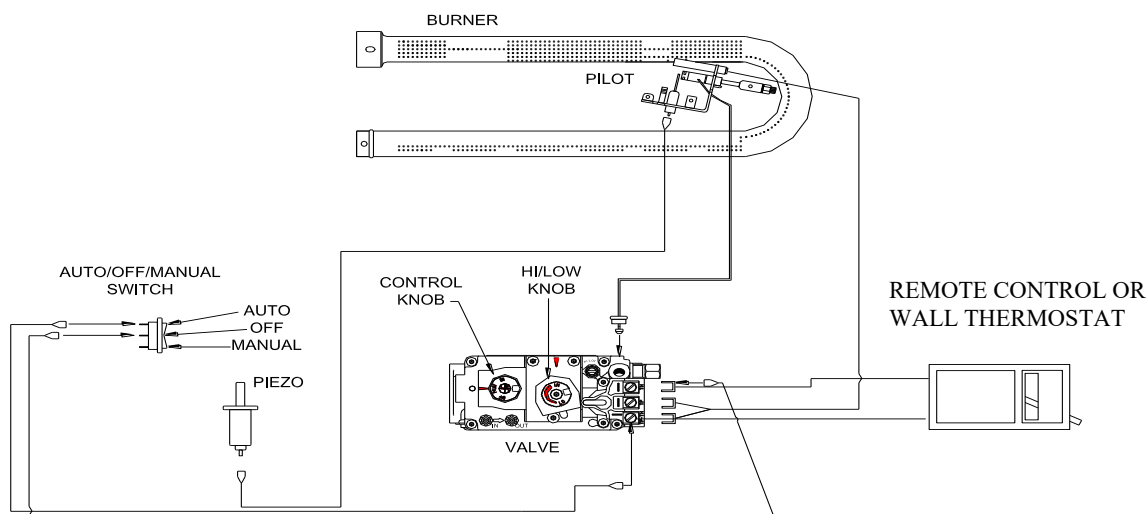

**NOTE:** Knob cannot be turned from “PILOT” to “OFF” unless knob is pushed in slightly. Do not force.

6. Wait (5) five minutes to clear out any gas. Then smell for gas, including near the floor. If you smell gas, STOP! Follow “B” in the safety information on the reverse side of this label. If you don’t smell gas, go to the next step.
  7. Find Pilot: The pilot is located in front of rear log and burner on right hand side of appliance. Fully open manual shutoff valve.
  8. Press in and turn knob on gas control counterclockwise  to “PILOT” and continue pressing in knob for (15) fifteen seconds.
  9. With control knob pressed in push down (in) and release igniter button (igniter button is located on front left hand side of appliance). This will light pilot. If needed, keep repeating this step until pilot lights.
  10. Keep control knob pressed in for (1) one minute after lighting pilot. After (1) minute, release control knob and it will pop back up. Pilot should remain lit. If pilot goes out, repeat steps 1 through 9.
- If knob does not pop up when released, stop and immediately call your service technician or gas supplier.
  - If pilot will not stay lit after several tries, turn the gas control knob to “OFF” and call your services technician or gas supplier.

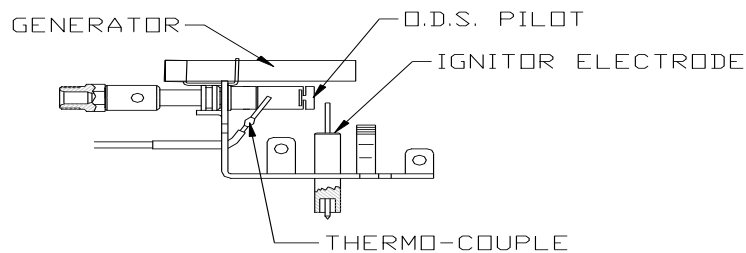

11. Turn control knob counterclockwise  to “ON”.
12. If using unit without wall thermostat place Auto/Off/Manual switch to manual position. If using wall thermostat place Auto/Off /Manual switch to auto position and place thermostat to a setting higher than room temperature.
13. Close access cover door.
14. Turn on all electrical power to appliance.
15. Your heater is equipped with a HI & LO control. Turn clockwise for Lo and counterclockwise for High.

### CAUTION

DO NOT TRY TO ADJUST HEATING LEVELS BY USING MANUAL SHUTOFF VALVE.

## TO TURN OFF GAS TO APPLIANCE

### SHUTTING OFF UNIT

1. Open access cover door.
2. If equipped with thermostat set to lowest setting.
3. Turn control knob clockwise  to full “OFF”.
4. Turn off all electric power to appliance if service is to be performed.
5. Close access cover door.

### SHUTTING OFF BURNER ONLY (Pilot stays lit.)

- \* Turn control knob clockwise  to “PILOT” position.



**CAUTION:** Hot while in operation. Do Not Touch. Keep children, clothing, furniture, gasoline and other liquids having flammable vapors away.

**CAUTION:** DO NOT TRY TO ADJUST HEATING LEVELS BY USING MANUAL SHUTOFF VALVE.

**WARNING:** Improper installation, adjustment, alteration, service or maintenance can cause property damage, personal injury or loss of life. Refer to owner’s information manual provided with this appliance. Installation and service must be performed by a qualified installer, service agency or gas supplier.

**IMPORTANT:** Always operate appliance at completely “ON” or completely “OFF” positions. Never use heater at a setting between these positions as this can result in improper combustion and excessive carbon monoxide emissions.

## MANUAL LIGHTING PROCEDURE

1. If pilot cannot be lit with piezo, it can be manually lit with the use of a paper match and a lighter rod.
2. Open access panel door located at bottom front of appliance.
3. Place match in holder and light. With left hand, turn control knob counterclockwise  to "PILOT" position. Press in gas control knob for fifteen (15) seconds.
4. Use rod to light match and ignite pilot. Pilot is located in front of rear log and burner on right hand side of appliance.
5. Continue to hold the control knob for an additional one (1) minute to ensure pilot is lit.
6. Turn control knob counterclockwise  to "ON" position. Push "ON/ OFF" toggle switch to "ON" position. Main burner should light.
7. Close access panel door.
8. Turn on all electrical power to appliance.

**NOTE:** This unit may be used with an optional Wall Thermostat. If so, Wall Thermostat needs to be set at a higher temperature than the room temperature.

## FLAME CHECK

A periodic check of the flames should be made. The pilot flame should always be present when gas logs are in operation. See Figure 4.

**Rear Flames:** The flames at rear or at either side of top log should be very similar, yellow in color, and should be about 3" to 4" above large rear log for natural gas logs and about 6" for propane (LP) gas log sets.

**Front Flame:** The flame should be 1-1/2" to 2" high and touch the back of front log. This will produce a red glow on this log.

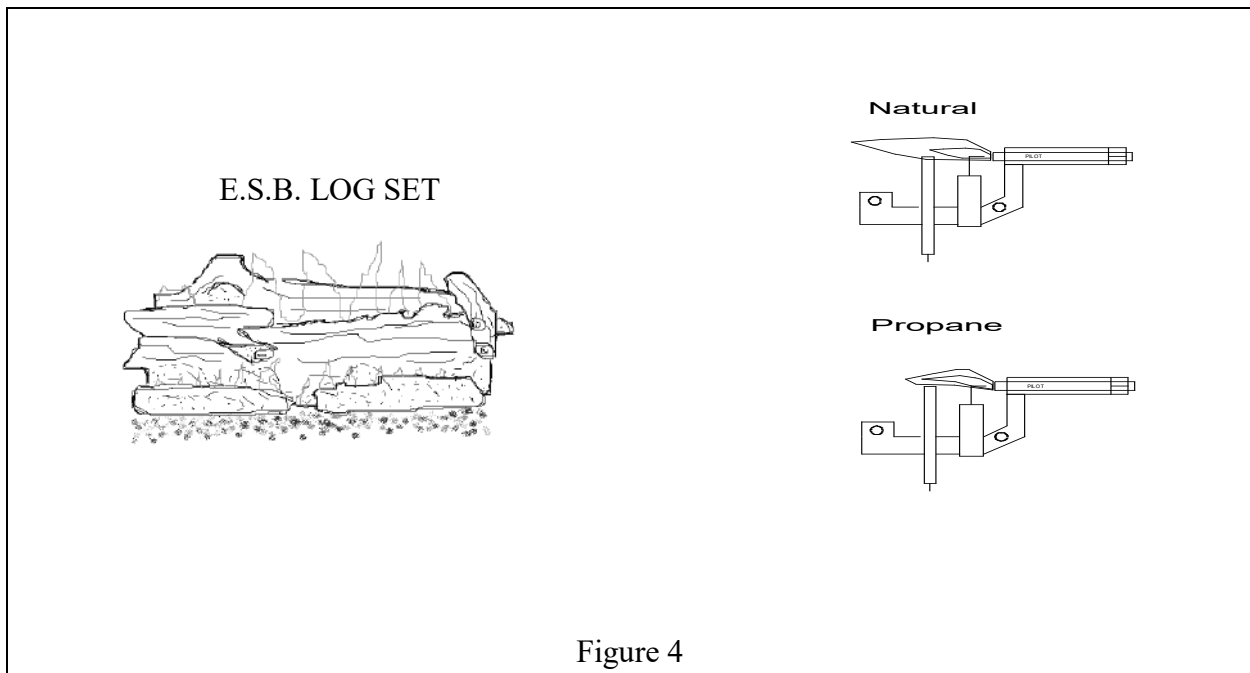

Figure 4

When used as a ventless heater, flue damper of a solid-fuel burning non-combustible fireplace must always be closed.

NOTE: The Vent-Free fireplace may be installed where permitted by local, state, and city codes.

In the absence of local codes, the latest edition of the *National Fuel Gas Code (ANSI Z223.1)* must be met.

## SECTION III

### INSTALLATION MODEL 34 CONTEMPORARY IN SOLID FUEL BURNING FIREPLACES

- (1) Model 34 Contemporary may be installed in a masonry fireplace. The **minimum fireplace dimension** must be 24" high, 29-1/2" wide, and 12" deep.
- (2) For minimum dimensions for the sidewall and mantel, see Figure 5.
- (3) Center heater in fireplace opening.

**NOTE:** See "Producing Adequate Air for Combustion And Ventilation" page 24.

**NOTE:** Installer of this appliance must mechanically (peel and stick) attach marking before installing to inside of firebox of solid-fuel burning fireplace or listed vent less firebox enclosure, into which unvented fireplace insert is installed. See example of marking on page 9 of this manual.

**CAUTION:** Cutting any sheet-metal parts of solid-fuel burning fireplace or listed ventless enclosure in which unvented fireplace is to be installed is prohibited.

**NOTE:** If factory-built fireplace has no gas access hole(s) provided, an access hole of 1.5 inch (37.5) diameter or less may be drilled through lower sides or bottom of firebox. This access hole must be plugged with non-combustible insulation after the gas supply line has been installed.

Refractory, glass doors, screen rails, screen mesh and solid-fuel log grates (if applicable) can be removed from fireplace before installing unvented fireplace insert.

**NOTE:** After the unit is positioned in fireplace, mark trim panels as follows:

- A. Set side panels in place, flat against fireplace. Mark down inside edge of trim panel to make a vertical reference line.

#### CEILING

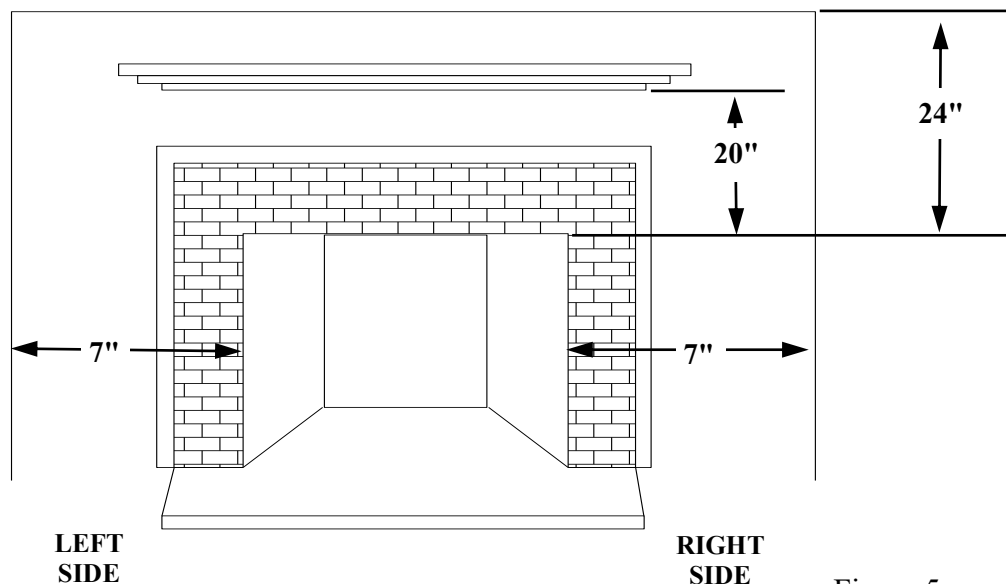

Figure 5



B. Set top (long) trim panel in place on top of unit. Panel should be flat against outside face of fireplace and standing vertically. Mark along lower edge of trim panel with a pencil to make reference line for mounting.

**NOTE:** If used in installation, trim panels or surrounds shall not seal ventilation openings in fireplace. Also provide adequate clearances around air openings

(4) Slide the unit out of fireplace far enough to work behind trim panel reference lines with a screw gun.

**NOTE:** You need to make sure supply gas line is hooked up at this time. Be sure to check for leaks at connection using soap and water. **DO NOT USE OPEN FLAME TEST FOR LEAKS.** With screws provided, attach both side trim panels. Next, attach top trim panels.

(5) Slide heater back into fireplace with trim panels flat against face of fireplace.

(6) After hooking up gas line, checking for leaks and mounting trim panels slide heater into fireplace.

(8) Place logs on burner base as shown on page 8.

(9) For gas hook-up page 7 and pressure tap test see instruction in Section II page 9.

**NOTE:** Smoke shelves, shields and baffles may be removed if attached by mechanical fasteners.

**WARNING:** Solid-Fuels shall not be burned in a fireplace in which an unvented room heater is installed.

**CAUTION:** Any outside air ducts and/or ash dumps in the fireplace shall be permanently closed at time of appliance installation.

**WARNING:** Before installing in a solid-fuel burning fireplace, the chimney flue and firebox must be cleaned of soot, creosote, ashes and loose paint by a qualified chimney cleaner.

## SECTION IV

### INSTALLATION OF MODEL 34 CONTEMPORARY (WS) OPTIONAL WOODEN SURROUND (KIT#PAKDFP34)

- (1) When choosing right location for your heater and surround (mantel) keep the following in mind:

**NOTE:** Due to high temperatures, this heater should be located out of traffic areas and away from furniture and draperies.

**CAUTION:** INSTALLATION MUST CONFORM TO LOCAL CODES. IN THE ABSENCE OF LOCAL CODES, INSTALLATION MUST CONFORM WITH NATIONAL GAS CODES.

**NOTE:** See Section II for gas hookup and pressure check.

**NOTE:** See "Producing Adequate Ventilation" page 24.

**WARNING: CHILDREN AND ADULTS SHOULD BE ALERTED TO HAZARDS OF HIGH SURFACE TEMPERATURES AND SHOULD STAY AWAY TO AVOID BURNS OR CLOTHING IGNITION. YOUNG CHILDREN SHOULD BE CAREFULLY SUPERVISED WHEN THEY ARE IN SAME ROOM WITH APPLIANCE**

**WARNING: DO NOT PLACE CLOTHING OR OTHER FLAMMABLE MATERIAL ON OR NEAR APPLIANCE.**

- (2) Position screen before leaving heater unattended.

- (3) Instructions for assembly of Wooden Surround (Mantel):

TOOLS NEEDED: Medium Phillips screwdriver, tape measure, power drill, and 5/16" socket.

STEP 1: Lay out all components.

STEP 2: Assemble end panels A & B to top front rail C.

STEP 3: Stand end panels and top front rail onto hearth.

**NOTE:**(Position back of end panels with back of hearth centering assembly from each end). Install front screws first, then pull back towards inside to square mantel. Install screws through back holes.

STEP 4: The owner must decide at this time if parts D, E, and F are to be wood or green. Beginning with panel E stand chosen color face out on hearth and flush against stop block (located inside end panel A) and attach. Position left end of top window D on top of E and attach. Slide panel F under right end of D and attach.

STEP 5: Take metal trim panel provided with surround (mantel) and position it on top of heater. Measure 11 1/8" from back of stove, center panel and attach with self-tapping screws provided.

- STEP 6: Place a cloth or blanket over front portions of surround (mantel) as not to scar wooden part of surround.
- STEP 7: Slide unit into front opening of surround so top metal trim panel and outer sides of heater meet flush with the surround front.
- STEP 8: Remove cloth or blanket from underneath stove.
- STEP 9: Take two metal “ell” brackets with screws provided and anchor back of fireplace to surround.
- STEP10: Place top on to surround (mantel), flush with back and equal on each end. Secure both ends and middle with screws.

EXPLODED VIEW OF MODEL 34 SURROUND KIT# PAKDFP34

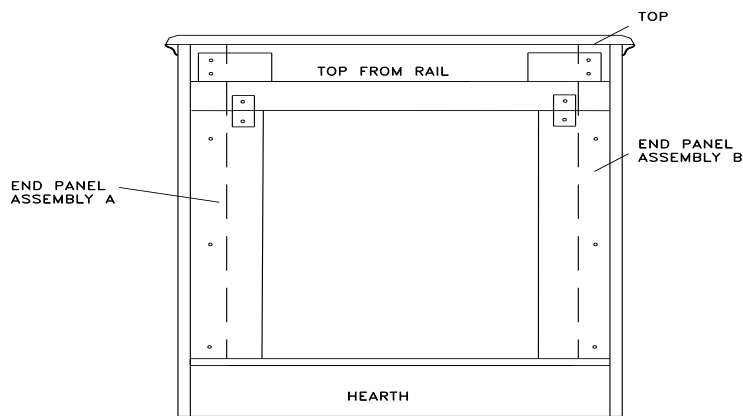
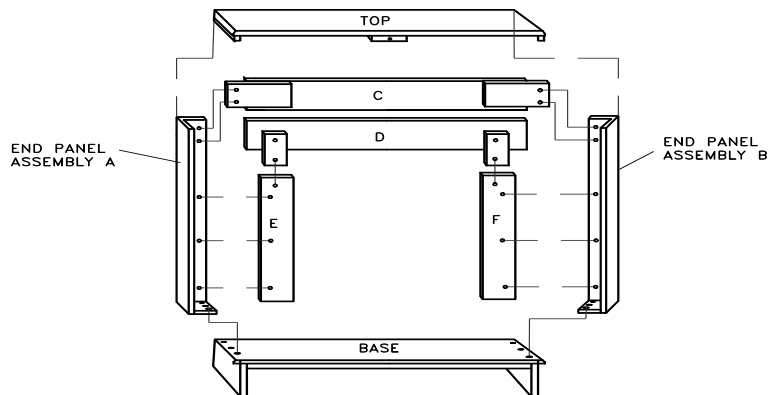

AS VIEWED FROM BACK OF SURROUND (MANTEL)

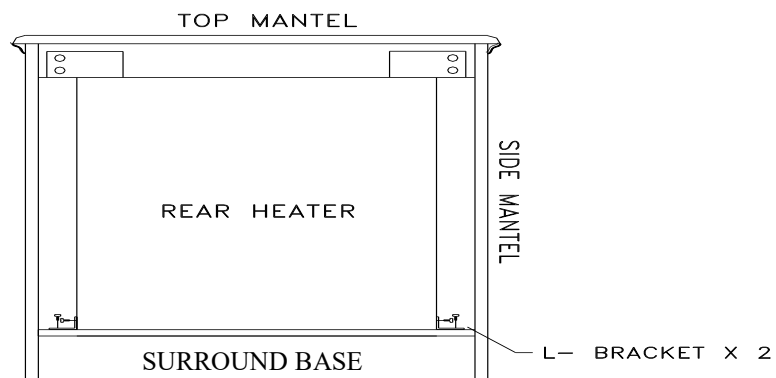

## SECTION V

### MODEL 34 CONTEMPORARY (ZC) ZERO CLEARANCE INSTALLATION

The installation must conform with local codes or in the absence of local codes, with *National Fuel Gas Code, ANSI Z223.1/NFPA54*.

**This appliance may be installed in an After-Market\* Permanently Lowcated Manufactured Home, where not prohibited by state or local codes.**

\* (After Market: Completion of sale, not for purpose of resale from manufacturer).

This appliance is only for use with the type of gas indicated on trating plate. This appliance is not convertible for use with other gases.

**NOTE:** See “Producing Adequate Air For Combustion And Ventilation” page 24.

#### CHOOSING THE LOCATION FOR YOUR FIREPLACE:

The figure below shows some of many ways your fireplace may be installed. Consider traffic pattern in your room and location of doors and windows. Moving air from ceiling fans, open doors and hot air grills may cause flames to soot. If a disturbance is found that affects flames, it must be eliminated by turning off ceiling fan, closing door or closing or moving hot air register. A corner location may be best where space is limited.

Your fireplace weighs no more than some of your fine furniture. If fireplace is located near a load bearing wall, additional supports to foundation will not be necessary. HEAVY FACINGS, SUCH AS BRICK, STONE, ETC., MAY REQUIRE ADDITIONAL FOUNDATION SUPPORT.

**NOTE: If this appliance is installed directly on carpeting, tile or other combustibile material, other than wood flooring, appliance shall be installed on a metal or wood panel extending full width and depth of appliance.**

#### GAS LINE

Gas supply line and electrical supply must be installed before framing in the fireplace by a licensed installer.

#### DRAFTS

Do not locate the fireplace in high traffic areas or areas exposed to high drafts and winds. Locate the fireplace away from furniture and draperies.

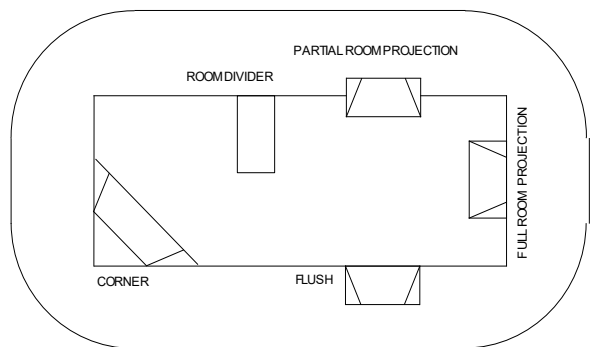

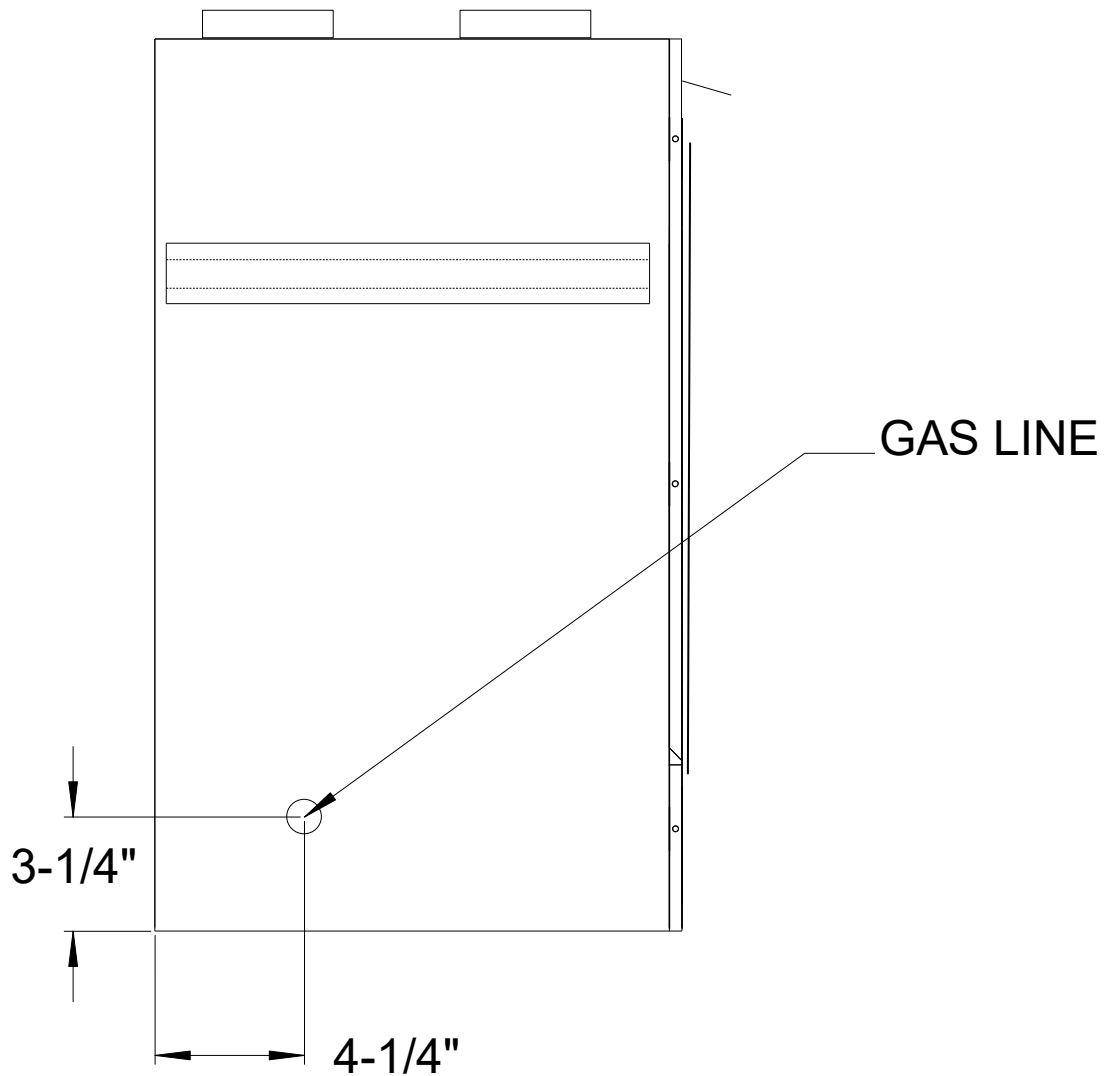

**WARNING:** Installation and repairs should be performed by a qualified service person. The appliance should be inspected before use and at least annually by a professional service person. More frequent cleaning may be required due to excessive lint from carpeting, bedding material, etc. It is imperative that control compartments, burners and circulating air passageways of appliance be kept clean.

## FIREPLACE CLEARANCES (ZC)

Fireplace may be placed directly on a combustible floor, against a combustible wall at marked clearances or on a raised wooden platform.

If fireplace is to be installed on a raised wooden platform, platform must be a continuous level surface. The fireplace must be secured in place so it cannot shift positions. Only header (see below) may rest on standoffs on top of firebox.

When the firebox is installed over carpeting, vinyl tile, or any combustible material other than wood flooring, it must be installed on a metal or wood panel extending its full width and depth.

Alternatively, carpeting, vinyl tile, etc. may be removed beneath fireplace before installing.

COMBUSTIBLE MATERIALS MUST NOT BE INSTALLED OVER OR TOUCH ANY BLACK PAINTED SURFACE. DO NOT BLOCK HEAT CIRCULATING AIR OUTLETS. DOING SO MAY RESULT IN POTENTIAL FIRE HAZARDS.

1. **Sidewall Clearances:** Clearances from side of fireplace opening to any adjacent combustible wall should not be less than 7" right side and 7" left side.
2. **Ceiling Clearances:** Ceiling height should not be less than 24" from top of fireplace opening.

## INSTALLING FIREBOX (ZC)

This list of specific instructions will help you make certain that every installation operation is performed correctly. Complete installation steps in sequence shown.

LOCAL BUILDING CODES SHOULD BE CONSULTED IN ALL CASES AS TO PARTICULAR REQUIREMENTS CONCERNING INSTALLATION OF FACTORY BUILT FIREPLACES. Select location for fireplace by taking into consideration factors previously outlined in "Choosing the Location."

### Framing Firebox

Width of framed opening must be 33". Height of framed opening must be 25 1/8". Entire fireplace can be elevated above floor to achieve a raised hearth effect. This can be done by adding a small platform to achieve desired height.

**NOTE:** Wiring for lower blower must be installed during framing stage. Insulation should be used in framing on back, sides, and top.

### Install Firebox

Install firebox into framed opening by placing it directly in front of opening and sliding it into proper position. Please follow wooden surround instructions.

### Level Firebox

Check level of the firebox on top edge of fireplace face. Shim if necessary.

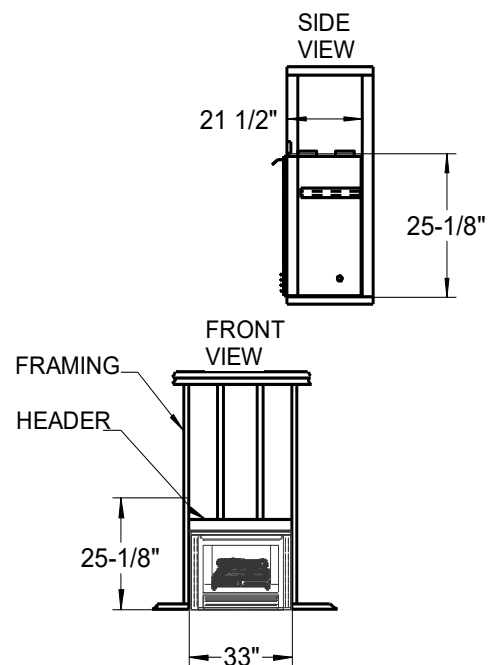
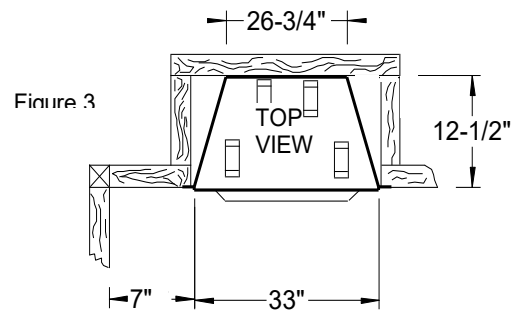

## FINISHING YOUR FIREPLACE (ZC)

There is a wide variety of finishing material available for your fireplace from formal wall treatments with marble and mantels, to rustic wood paneling, stone or brick. Non-combustible materials used in this installation such as slate, tile, marble, etc. must be at least 1/2" thick.

**IT IS IMPORTANT THAT BLACK FACE OF FIREPLACE NOT BE COVERED WITH ANY TYPE OF COMBUSTIBLE MATERIAL.**

Check to see whether man-made brick and stone are made of non-combustible materials before using them on face of fireplace. Some of these products contain combustible materials. Combustible wall

coverings such as paneling or wall-board may not overlap black face of fireplace. Space between wall covering and fireplace should be sealed with a heat resistant material such as rock wool insulation or mortar.

**NOTE:** An "L" shaped steel lintel must be installed across top of firebox opening where facing materials such as brick or stone is used on the face of firebox. It acts as a support/firestop. It should be attached to face of fireplace with screws and sealed to fireplace with a heat-resistant sealer.

### CLEARANCES (ZC)

To ensure a safe installation, the following must be carefully observed.

1. **Sidewall Clearances:** Clearances from side of fireplace opening to any adjacent combustible wall should not be less than 7".
2. **Ceiling Clearances:** Ceiling height should not be less than 24" from the top of fireplace opening.
3. **Mantel Clearances:** Clearance from top of heater to mantel or mantel supports should not be less than 20".
4. **Floor Clearances:** No clearance is required if the appliance is installed per these instructions.

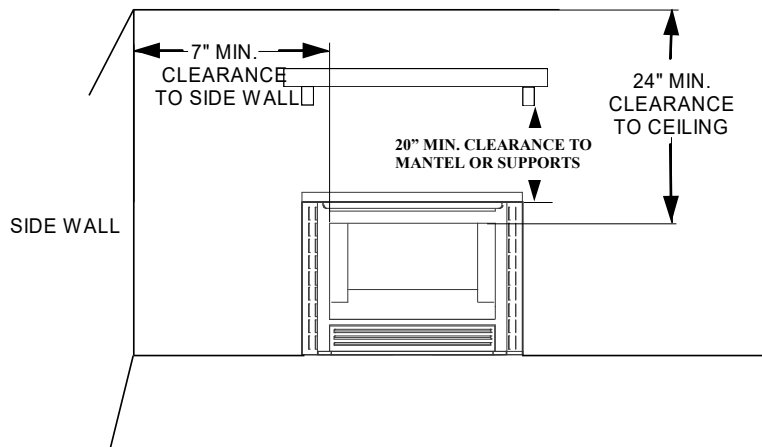

**SECTION VI**  
**AFTER MARKET PERMANENTLY LOCATED**  
**MANUFACTURED HOME**  
**INSTALLATION**

**NOTE:** See “Producing Adequate Air For Combustion And Ventilation” page 24

**THIS APPLIANCE MAY BE INSTALLED IN AN AFTERMARKET\*, PERMANENTLY LOCATED, MANUFACTURED HOME, WHERE NOT PROHIBITED BY LOCAL CODES.**

**\*(After Market: Completion of sale, not for purpose of resale from manufacturer.)**

**THIS APPLIANCE IS ONLY FOR USE WITH THE TYPE OF GAS INDICATED ON RATING PLATE. THIS APPLIANCE IS NOT CONVERTIBLE FOR USE WITH OTHER GASES.**



## PRODUCING ADEQUATE AIR FOR COMBUSTION AND VENTILATION

**This section is for residential or manufactured (mobile) installation**

“This heater shall not be installed in unusually tight construction unless provisions are adequate for combustion and ventilation air.”

**NOTE:** This heater shall not be installed in a room or space unless the required volume of indoor combustion air is provided by the method in *National Fuel Gas Code, ANSI Z223.1/NFPA 54*, the *International Fuel Gas Code*, or applicable codes.

**National Fuel Gas Code, ANSI Z223.1/NFPA 54** defines unusually tight construction or unconfined space as a space whose volume is less than 50 cubic feet per 1,000 BTU per hour (4.8m<sup>3</sup> per kw) of aggregate input rating of all appliances installed in that space and an unconfined space as a space whose volume is not less than 50 cubic feet per 1,000 BTU per hour (4.8m<sup>3</sup> per kw) of aggregate input rating of all appliances installed in that space. Rooms communicating directly with space in which appliances are installed, through openings not furnished with doors, are considered a part of unconfined space.

**“WARNING: IF AREA IN WHICH HEATER MAY BE OPERATED DOES NOT MEET THE REQUIRED VOLUME FOR INDOOR COMBUSTION AIR, COMBUSTION AND VENTILATION AIR SHALL BE PROVIDED BY ONE OF METHODS DESCRIBED IN NATIONAL FUEL GAS CODE, ANSI Z223.1/NFPA 54, THE INTERNATIONAL FUEL GAS CODE OR APPLICABLE CODES.”**

**“WARNING: IF AREA IN WHICH HEATER MAY BE OPERATED IS SMALLER THAN THAT DEFINED AS AN UNCONFINED SPACE OR IF BUILDING IS OF UNUSUALLY TIGHT CONSTRUCTION, PROVIDE ADEQUATE AIR FOR COMBUSTION AND VENTILATION BY ONE OF METHODS DESCRIBED IN NATIONAL FUEL GAS CODE, ANSI Z223.1/NFPA 54 AIR FOR COMBUSTION AND VENTILATION OR APPLICABLE LOCAL CODES.”**

Unusually tight construction is defined as construction where:

- a) Walls and ceilings exposed to the outside atmosphere have a continuous water vapor retarder with a rating of 1 perm (6 x 10<sup>-11</sup> kg per pa-sec-m<sup>2</sup>) or less with openings gasketed or sealed.
- b) Weather stripping has been added on openable windows and doors.
- c) Caulking or sealants are applied to areas such as joints around window and door frames, between sole plates and floors, between wall-ceiling joints, between wall panels, at penetrations for plumbing, electrical and gas lines and at other openings.

**NOTE: SOME AREAS IN THE UNITED STATES HAVE HIGHER REQUIREMENTS FOR CUBIC FEET PER 1000 BTU/ HOUR INPUT. (EX. CINCINNATI, OHIO CODES REQUIRE 70 CUBIC FEET). CHECK YOUR LOCAL CODE BEFORE INSTALLATION.**

## DETERMINING FRESH-AIR FLOW FOR HEATER LOCATION

DETERMINE IF YOU HAVE A UNUSUALLY TIGHT CONSTRUCTION OR UNCONFINED SPACE

Use this worksheet to determine if you have unusually tight construction or unconfined space.

**SPACE:** Includes the room in which you will install heater plus adjoining rooms with doorless passageways or ventilation grills between the rooms.

1. **Determine the volume of the space (length x width x height).**

Length x Width x Height = \_\_\_\_\_ cu.ft.(volume of space)

EXAMPLE: 20 ft.(Length) x 16 ft.(Width) x 8 ft.(ceiling Height)=  
2560 cu. ft. (volume of space)

If additional ventilation to adjoining room is supplied with grills or openings, add the volume of these rooms to the total volume of the space.

2. **Divide the space volume by 50 cubic feet to determine the maximum BTU/Hr the space can support.**

\_\_\_\_\_ (volume of space)/50 cu. ft. =maximum BTU/Hr the space can support

EXAMPLE: 2560 cu. ft. (volume of space /50 cu. Ft .= 51.2 or  
51200 (maximum BTU/Hr the space can support)

3. **Add the BTU/Hr of all fuel burning appliances in the space.**

Vent-free heater		_____ BTU/Hr
*Gas water heater		_____ BTU/Hr
Gas furnace		_____ BTU/Hr
Vented gas heater		_____ BTU/Hr
Gas fireplace logs		_____ BTU/Hr
Other gas appliances	+	_____ BTU/Hr
Total	=	_____ BTU/Hr

Example: Gas water heater 40000 BTU/Hr  
Vent-free heater + 18000 BTU/Hr  
Total = 58000 BTU/Hr

\*Does not include direct-vent gas appliances. Direct-vent draws combustion air from outdoors and vents to the outdoors.

4. **Compare the maximum BTU/Hr the space can support with actual amount of BTU/Hr used.**

\_\_\_\_\_ BTU/Hr (maximum the space can support)

\_\_\_\_\_ BTU/Hr (actual amount of BTU/Hr used)

Example: 51200 BTU/Hr (maximum the space can support)

58000 BTU/Hr (actual amount of BTU/Hr used)

Space in above example is unusually tight construction because actual BTU/Hr used is more than maximum BTU/Hr the space can support. You must provide additional fresh air. Your options are as follows:

- A. Rework worksheet, adding space of an adjoining room. If extra space provides an unconfined space, remove door to adjoining room or add ventilation grills between rooms. See “Ventilation Air From Inside Building”, page 37.
- B. Vent room directly to the outdoors. See “Ventilation Air From Outdoors”, page 27.
- C. Install a lower BTU/Hr heater, if lower BTU/Hr size makes room unconfined.

If actual BTU/Hr used is less than the maximum BTU/Hr the space can support, space is an unconfined space. You will need no additional fresh air ventilation.



**WARNING:**

**YOU MUST PROVIDE ADDITIONAL VENTILATION AIR IN UNUSUALLY TIGHT CONSTRUCTION**

## AIR FOR COMBUSTION AND VENTILATION INSIDE BUILDING

This fresh air would come from an adjoining unconfined space. When venting to an adjoining space, you must provide two permanent openings: one within 12" of ceiling and one within 12" of floor, on wall connecting two spaces. (See Options 1 and 2, Figure 11.) You can also remove door into adjoining room. (See Option 3, Figure 11.)

### WARNING

**REWORK WORKSHEET, ADDING SPACE OF ADJOINING UNCONFINED SPACE. COMBINED SPACES MUST HAVE ADEQUATE AMOUNT OF AIR TO SUPPLY ALL APPLIANCES IN BOTH SPACES.**

**NOTE:** Each opening shall have a minimum free area of 1 square inch per 1000 BTU's per hour of the total input ratings of all gas utilization equipment in the confined space, but not less than 100 square inches.

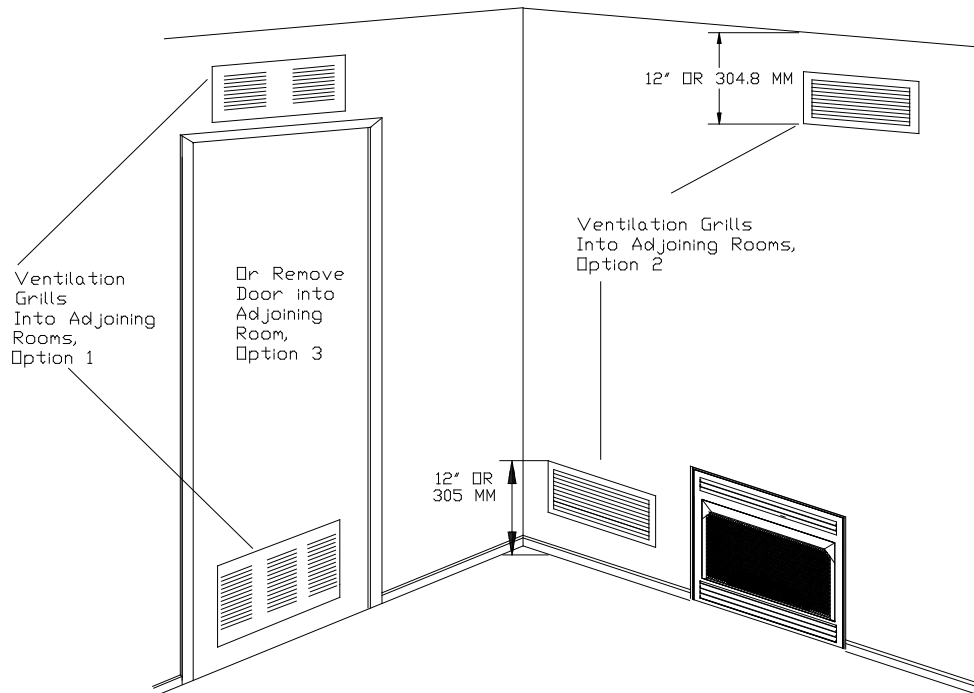

Figure 11 Ventilation Air From Inside Building



## WARNING

**THIS APPLIANCE MUST HAVE ADEQUATE AMOUNT OF AIR FOR PROPER OPERATION. IF NOT, POOR FUEL COMBUSTION COULD RESULT. READ FOLLOWING INSTRUCTIONS TO ENSURE PROPER AMOUNT OF AIR FOR THIS AND OTHER FUEL-BURNING APPLIANCES IN YOUR HOME.**

### AIR FOR COMBUSTION AND VENTILATION OUTDOORS

Provide extra fresh air by using ventilation grills or ducts. You must provide two permanent openings: one within 12" of ceiling and one within 12" of floor. Connect these items directly to outdoors. These spaces include attics and crawl spaces. Follow **National Fuel Gas Code NFPA 54/ANSI Z223.1**, Section 5.3, "Air For Combustion and Ventilation" for required size of ventilation grills or ducts.

**IMPORTANT:** Do not provide openings for inlet air into attic if attic has a thermostat-controlled power vent. Heated air entering the attic will activate the power unit.

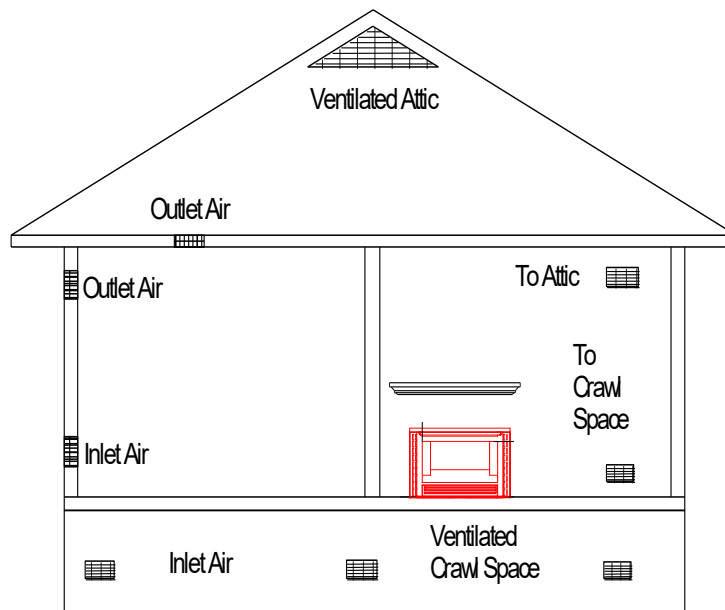

Ventilation Air From Outdoors

## IMPORTANT SAFEGUARDS

Although your gas logs are very realistic in appearance, it is not a real burning fireplace and must not be used for burning rejected material.

- To avoid irreparable damage to heater or personal injury, matches, paper, garbage or any other material **must not** be placed or thrown on top of logs or into flames.
- To avoid personal injury, do not touch hot surfaces when heater is operating.
- Close supervision is necessary when heater is being operated near children.

### WARNING:

**THE LOGS ARE MANUFACTURED FROM BONDED CERAMIC FIBER. THIS IS A COMMONLY USED MATERIAL IN INDUSTRY WORLDWIDE. IN EVENT THAT A LOG SHOULD BE REMOVED, CARE SHOULD BE TAKEN NOT TO DAMAGE BONDED MATERIAL. INTENTIONAL MISUSE OR DELIBERATELY FRAGMENTING MATERIAL COULD LEAD TO INHALING FIBERS AND BE HAZARDOUS TO YOUR HEALTH.**

**THIS HEATER IS INTENDED FOR USE AS A GAS HEATER FIREPLACE AS DESCRIBED IN THESE INSTRUCTIONS. IT SHOULD NOT BE USED FOR ANY OTHER PURPOSE.**

## CLEANING

**CAUTION: BEFORE CLEANING OR MOVING THESE LOGS OR OTHER PARTS OF HEATER, BE SURE TO READ ABOVE SECTIONS ON “IMPORTANT SAFEGUARDS.”**

### CLEANING BURNER AND PILOT AREA:

Turn unit off and let cool. The appliance must be turned “OFF” before cleaning inside firebox (burn area), make sure pilot is “OFF” completely and appliance has cooled.

- All cleaning should be carried out when heater is cold. Limited cleaning is required with normal use. Dusting front of base, top of piezo cover or control knob panel may be required occasionally. Do not use cleaning fluids to clean logs or any other part of heater.
- If flames show unusual shapes or behavior or if burner fails to ignite properly, burner holes may require cleaning. If this occurs, contact your nearest dealer to service heater.
- Slide screens open if equipped or open doors.
- Remove logs very gently ( to clean logs use a soft brush or compressed air). Place logs aside. NOTE: If unit is equipped with embers on front burner remove and put aside before cleaning area.
- Use vacuum cleaner with furniture brush attached and gently clean burner. It may be necessary to use brass brush when cleaning the burner making sure all holes in burner are open. Vacuum pilot, making sure not to damage any of parts. Replace logs in proper position, replace embers if equipped ( See Manual page 7).
- Close screens or door. Make sure unit is plugged up.

### WARNING:

Failure to keep the primary air openings (s) of the burner (s) clean may result in sooting and property damage.

## WIRING DIAGRAM

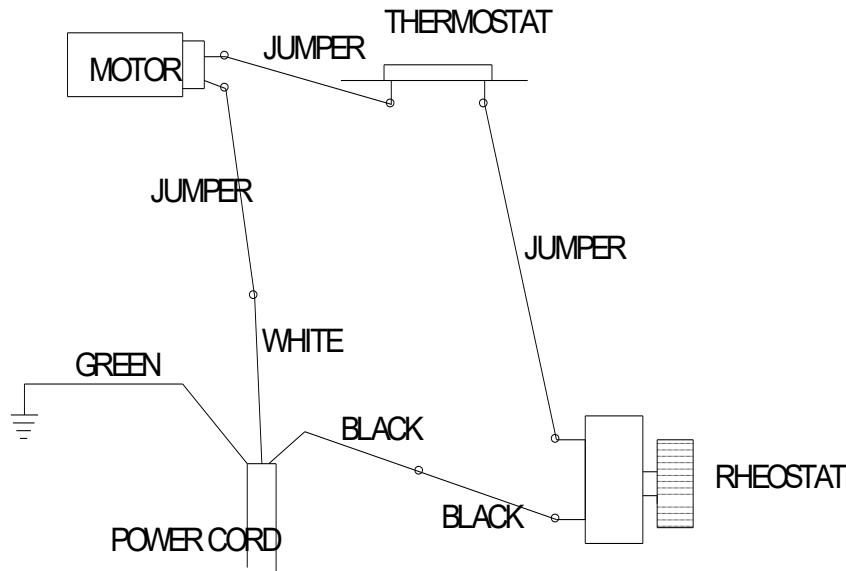

**WARNING:** CHILDREN AND ADULTS SHOULD BE ALERTED TO HAZARDS OF HIGH SURFACE TEMPERATURES AND SHOULD STAY AWAY TO AVOID BURNS OR CLOTHING IGNITION. YOUNG CHILDREN SHOULD BE CAREFULLY SUPERVISED WHEN THEY ARE IN SAME ROOM WITH APPLIANCE

**WARNING:** DO NOT PLACE CLOTHING OR OTHER FLAMMABLE MATERIAL ON OR NEAR APPLIANCE.

**NOTE:** If any of the original wire as supplied with the gas appliance must be replaced, it must be replaced with a wire of at least a 105° C. temperature rating.

**NOTE:** Installation and repair should be done by a qualified service person. This heater should be inspected before use and at least annually by a qualified service person. More frequent cleaning may be required due to excessive lint from carpeting, bedding material, etc. It is imperative that control compartments and circulating air passageways of heater be kept clean.

**CAUTION:** Label all wires prior to disconnection when servicing controls. Wiring errors can cause improper and dangerous operation. Verify proper operation after servicing.

**WARNING: ELECTRICAL GROUNDING INSTRUCTION: HEATER IS EQUIPPED WITH A THREE-PRONG PLUG FOR YOUR PROTECTION AGAINST SHOCK HAZARD AND SHOULD BE PLUGGED DIRECTLY INTO A PROPERLY GROUNDED THREE-PRONG RECEPTACLE.**

**NOTE:** #PESBRO84 Blower may be used with Model 34 Manhattan.  
Rating: 120 volts/60HZ/1.1 Amps.  
See page 29 for wiring diagram.

**NOTE:** For convenience, allow licensed electrician to install properly grounded 3-plug receptacle near unit.

**Installation and repairs should be performed by a qualified service person. Appliance should be inspected before use and at least annually by a professional service person. More frequent cleaning may be required due to excessive lint from carpeting, bedding material, etc. It is imperative that control compartments, burners and circulating air passageways of appliance be kept clean.**

## CLEANING BOTTOM COMPARTMENT - MOTOR AND MOTOR REPLACEMENT

1. Unplug power cord.
2. Open access door at front bottom facing unit to access bottom compartment.
3. Using vacuum cleaner, remove all dust, fuzz, dirt and foreign materials from bottom of stove. Also vacuum the fan blade on motor. They must be kept clean to ensure peak performance of motor.
4. Check to see if there are no loose fitting.
5. If motor needs to be replaced, use a 5/16" hex driver to loosen and remove the (2)-two screws holding motor bracket to motor support. (See Figure 14 ).
6. Mark wires and disconnect motor from unit.
7. When replacing motor use only Part # PESBR085.
8. Reconnect all marked wires to motor.
9. Reinstall motor buy installing the two screws through motor bracket into motor support and tighten screws using 5/16" hex driver.

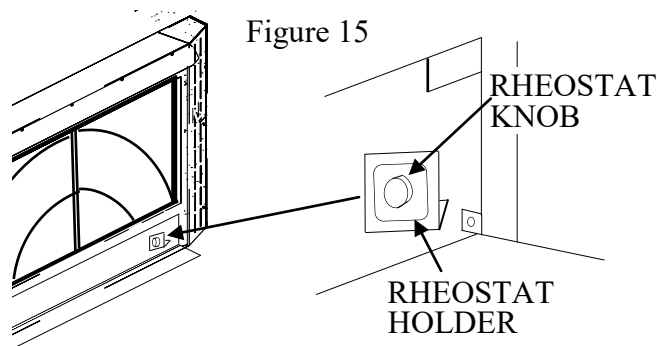
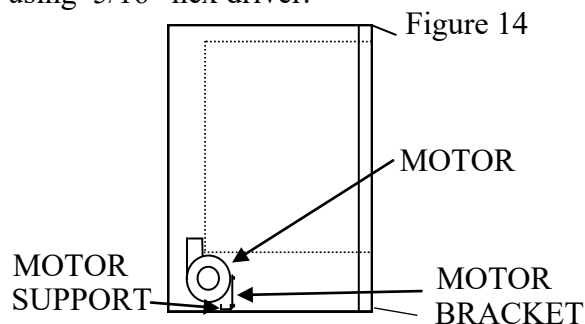

## RHEOSTAT REPLACEMENT

1. If rheostat needs to be replaced, open access door at front bottom facing unit, rheostat is bottom right of compartment. Mark wires and disconnect rheostat from unit. (See Figure 155).
2. Remove knob from rheostat by gently pulling it. Remove lock nut from stem of rheostat and remove from rheostat holder.
3. When replacing rheostat use only Part # PEBC204.
4. Reinstall rheostat into rheostat holder. Reinstall lock nut onto stem of rheostat and tighten nut.
5. Replace knob onto stem of rheostat.
6. Reconnect all marked wires to rheostat.

## THERMOSTAT REPLACEMENT

1. Thermostat is located at top front of unit under visor in room air channel right side of opening.(See Figure 16).
2. Thermostat is positioned under flanges of thermostat bracket. Gently bend flanges of thermostat bracket up and slide thermostat out.
3. Disconnect (2) two wires from thermostat electrical post.
4. When replacing thermostat use only Part # PE400130.
5. To reinstall thermostat, reconnect the (2) two wires to electrical post of thermostat. NOTE: On a new thermostat you bend the electrical post up 90° then reconnect the (2) two wires to electrical post of thermostat.
6. Slide thermostat wings under the flanges of thermostat bracket, making sure disk of thermostat is flat against inner top of unit. Gently bend flanges of thermostat bracket down to hold thermostat firmly in place against surface of unit.

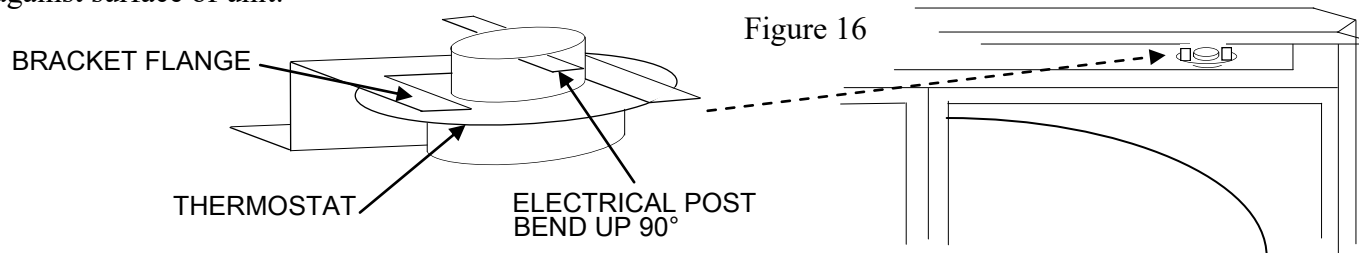



## TROUBLESHOOTING

### WARNING

**TURN OFF, UNPLUG HEATER AND LET COOL BEFORE SERVICING. ONLY A QUALIFIED SERVICE PERSON SHOULD SERVICE AND REPAIR HEATER.**

### CAUTION

**NEVER USE A WIRE, NEEDLE OR SIMILAR OBJECT TO CLEAN ODS/PILOT. THIS CAN DAMAGE ODS/PILOT.**

<b>OBSERVED PROBLEM</b>	<b>POSSIBLE CAUSE</b>	<b>SOLUTION</b>
Igniter button is pressed No spark at ODS/Pilot	Igniter electrode positioned incorrectly	Replace igniter
	Igniter electrode broken	Replace igniter
	Igniter electrode not connected to igniter cable	Reconnect igniter cable
	Igniter cable pinched or wet	Free igniter cable if pinched by any metal or tubing. Keep igniter cable dry
	Piezo igniter nut is loose	Tighten nut holding piezo igniter to heater cabinet. Nut is located inside heater cabinet at top
	Broken igniter cable	Replace igniter cable
	Bad piezo igniter	Replace piezo igniter
<b>OBSERVED PROBLEM</b>	<b>POSSIBLE CAUSE</b>	<b>SOLUTION</b>
Igniter button is pressed Spark at ODS/Pilot No Ignition	Gas supply turned off or manual shutoff valve is closed	Turn on gas supply or open manual shutoff valve
	Control knob not in "PILOT" position	Turn control knob to "PILOT" position
	Control knob not pressed in while in "PILOT" position	Press in control knob while in "PILOT" position

<b>OBSERVED PROBLEM</b>	<b>POSSIBLE CAUSE</b>	<b>SOLUTION</b>
Igniter button is pressed Spark at ODS/Pilot No Ignition (continued)	Air in gas lines when installed	Continue to hold down control knob. Repeat igniting operation until air is removed.
	Depleted gas supply	Contact local propane gas company
	ODS/Pilot is clogged	Clean ODS/Pilot or replace ODS/Pilot assembly
	Gas regulator setting is not correct	Replace gas regulator

<b>OBSERVED PROBLEM</b>	<b>POSSIBLE CAUSE</b>	<b>SOLUTION</b>	
ODS/PILOT lights but flame goes out when control knob is released	Control knob is not fully pressed in	Press control knob completely	
	Control knob not pressed in long enough	After ODS/Pilot lights keep control knob pressed thirty (30) seconds	
	Safety interlock system has been triggered (if equipped)	Wait one (1) minute for safety interlock system to reset	
	Manual shutoff valve not fully open	Fully open manual shutoff valve	
	Thermo-couple connection loose at control valve	Hand tighten until snug, then tighten 1/4 turn	
	Pilot flame not touching thermo-couple, which allows thermo-couple to cool, causing pilot flame to go out. This problem can be caused by one or both of the following: A) Low gas pressure B) Dirty or partially clogged ODS/Pilot	A) Contact local propane gas company	B) Clean ODS/Pilot (See Cleaning and Maintenance) or replace ODS/Pilot assembly
		B) Dirty or partially clogged ODS/Pilot	
	Control valve damaged	Replace valve control	

<b>OBSERVED PROBLEM</b>	<b>POSSIBLE CAUSE</b>	<b>SOLUTION</b>
Burner does not light after ODS/Pilot is lit	Burner orifice is clogged	Clean burner (see Cleaning and Maintenance) or replace burner orifice
	Inlet gas pressure is too low	Contact local propane gas company
Delayed ignition of burner	Manifold pressure is too low	Contact local propane gas company
	Burner orifice is clogged	Clean burner (see Cleaning and Maintenance) or replace burner orifice
Burner backfiring during combustion	Burner orifice is clogged or damaged	Clean burner (see Cleaning and Maintenance) or replace burner orifice
	Burner damaged	Replace burner
	Gas regulator defective	Replace gas regulator
Slight smoke or odor during initial operation	Residues from manufacturing process	Problem will stop after a few hours of operation
Heater produces a whistling noise when burner is lit	Turning control knob to “HI” position when burner is cold (if equipped with this type of valve)	Turn control knob to “LOW” position and allow to warm
	Air in gas line	Operate burner until air is removed from line. Call local propane company to check gas line
	Air passageways on heater blocked	Observe minimum installation clearances
	Dirty or partially clogged burner orifice	Clean burner or replace orifice

# WARNING

**IF YOU SMELL GAS:**

- \* **SHUT OFF GAS SUPPLY**
- \* **DO NOT TRY TO LIGHT APPLIANCE**
- \* **DO NOT TOUCH ANY ELECTRICAL SWITCH; DO NOT USE ANY PHONE IN YOUR BUILDING**
- \* **IMMEDIATELY CALL YOUR GAS SUPPLIER FROM A NEIGHBOR'S PHONE. FOLLOW THE GAS SUPPLIER'S INSTRUCTIONS.**
- \* **IF YOU CANNOT REACH YOUR GAS SUPPLIER, CALL THE FIRE DEPARTMENT.**

**IMPORTANT:** Operating heater where impurities in air exist may create odors. Cleaning supplies, paint, paint remover, cigarette smoke, cements and glues, new carpet or textiles, etc. create fumes. These fumes may mix with combustion air and create odors.

OBSERVED PROBLEM	POSSIBLE CAUSE	SOLUTION
Heater produces a clinking/ticking noise just after burner is lit or shut off	Metal expands while heating or contracts while cooling	This is common with most heaters. If noise is excessive, contact a qualified service person
Heater produces unwanted odors	Heater burning vapors from paint, hairspray, glues, etc. (See <b>Important</b> above)	Ventilate room. Stop using odor causing products while heater is running
	Low fuel supply	Refill supply tank
	Gas leak (See <b>WARNING</b> above)	Locate and control all leaks (See Checking Gas Connections)
Heater shuts off in use (ODS operates)	Not enough fresh air is available	Open window/door for ventilation
	Low line pressure	Contact local propane co.
	ODS/Pilot is partially clogged	Clean ODS/Pilot
Gas odor even when control knob is in OFF position	Gas leak (See <b>WARNING</b> above).	Locate and correct all leaks (see Checking Gas Connections)
	Control valve defect	Replace control valve
Gas odor during combustion	Foreign matter between control valve and burner	Remove foreign matter from gas tubing
	Gas leak (See <b>WARNING</b> above)	Locate and correct all leaks (see Checking Gas Connections)

## SERVICING

Repair and replacement work should only be performed by a qualified service technician.

Always shut off the gas supply and make sure heater is cool before beginning any service operation. Check for gas leaks after servicing.



## REPAIR PARTS



A parts list with exploded view follows. Always include correct name, part number and model number of heater when ordering service parts. Please contact your local dealer or distributor when ordering . If one is not available, you may contact.

New Buck Corporation  
200 Ethan Allen Drive  
PO Box 69  
Spruce Pine, NC 28777

## REPLACEMENT PARTS

### SIT MILLIVOLT VALVE MA344EBBA ESB BASE

(Picture on page 38)

A parts list with exploded view follows. Always include correct name, part number and model number of the heater when ordering service parts.

KEY#	PART DESCRIPTION	PART NUMBER
1.	O.D.S. Pilot O.P. Assembly (LP)	PE 8404C
1.	O.D.S. Pilot O.P. Assembly (NAT)	PE 8204C
2.	Pilot Tube 3/16"	MF 31612 ALMTUB
3.	Rear Burner	PO VE1002
4.	Front Burner	PO 383436
5.	Inlet Elbow	PH 4966
6.	3/8" Comp. Nut & Sleeve	PH 616 & PH 606
7.	3/8" Burner Supply Tube (Flex) - 3 pieces@12"	PO T6-12
8.	30" Switch Wires	PE 30JUMPER
9.	Carling Switch (Auto/Off/Manual)	PE RC211RB
10.	Piezo Striker	PE 124461
11.	Piezo 18" Ignitor Wire	PE 8400-014
12.	Male Run Tee Fitting	PH 64A-66
13.	Manifold Outlet Connector	PH 68A-6C
14.	Orifices (LP)            Front (#1.25mm)	PO 125 MVORF
	Rear (#.046")	PO 046 MVORF
14.	Orifices (NAT)        Front (#2.05mm)	PO 205 MVORF
	Rear (#48)	PO 48 MVORF
15.	820 M.V. S.I.T. Valve (LP)	LP - PE 820636
15.	820 M.V. S.I.T. Valve (NAT)	NAT - PE 820638
16.	8" L 3/8" Burner Supply Line (3/4"-3/8" Flare & 3/8" Comp. N&S Fittings)	MF382ALMTUB
17.	1/2" Ball Valve with Pressure Tap	PO 110-553
18.	1/2" Flex Line	PO 20-2131-18
19.	Burner Base Assembly	L,P, - #MA344ESBBALP / NAT - #MA344ESBBANAT
* Log Set	—Ember Stove Base (Ceramic)	POCR34ESBLG

# SIT MILLIVOLT VALVE ESB BASE

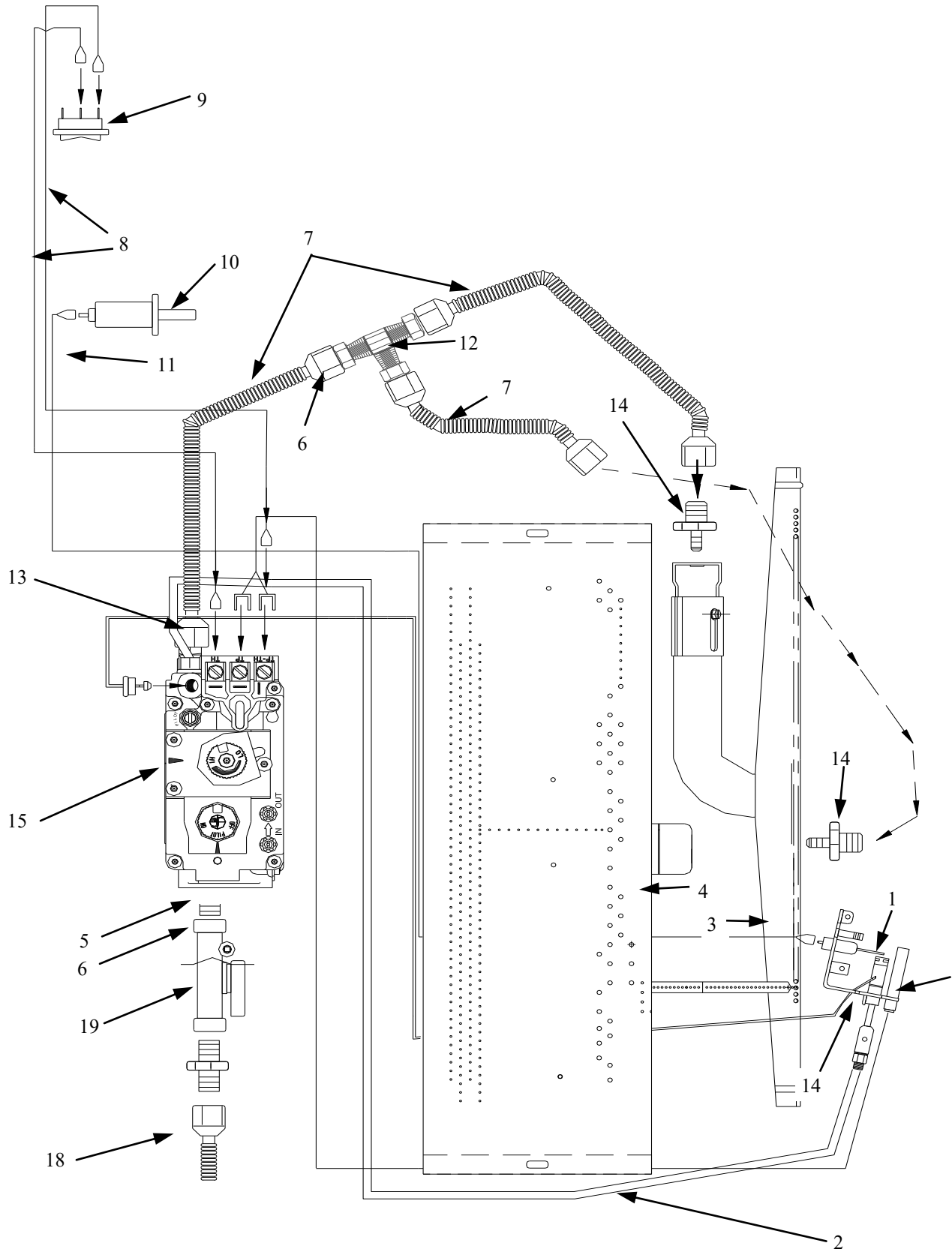

## **NEW BUCK CORPORATION**

We reserve right to amend these specifications at any time without notice. The only warranty applicable is our standard written warranty. We offer no other warranty, expressed or implied.

### **LIMITED WARRANTY**

### **VENT-FREE GAS LOG HEATER**

New Buck warrants this product to be free from defects in materials and components for two (2) years from date of first purchase, provided that product has been properly installed, operated and maintained in accordance with all applicable instructions. To make a claim under this warranty Bill of Sale or canceled check must be presented.

This warranty is extended only to original retail purchaser and covers cost of parts required to restore the heater to proper condition. Warranty parts **MUST** be obtained through an authorized Buck Stove dealer and/or New Buck, who will provide original factory replacement parts. Failure to use original factory replacement parts voids this warranty. The heater **MUST** be installed by a qualified installer in accordance with all local codes and instructions furnished with unit.

Warranty does not apply to parts that are not in original condition, normal wear and tear or parts that fail or become damaged as a result of misuse, accidents, lack of proper maintenance or defects caused by improper installation.

#### **WARRANTY DOES NOT COVER:**

- Removal and re-installation cost
- Labor costs for replacements or repairs
- Transportation
- Cost of service call to diagnose trouble
- Painted surfaces
- Damage or defect caused by improper installation, accident, misuse, abuse, or alteration

**TO FULL EXTENT ALLOWED BY LAW OF JURISDICTION THAT GOVERNS THE SALE OF PRODUCT, THIS EXPRESS WARRANTY EXCLUDES ANY AND ALL OTHER EXPRESSED WARRANTIES AND LIMITS DURATION OF ANY AND ALL WARRANTIES, INCLUDING WARRANTIES OF MERCHANTABILITY AND FITNESS FOR A PARTICULAR PURPOSE TO ONE (1) YEAR FROM DATE OF FIRST PURCHASE. NEW BUCK LIABILITY IS HEREBY LIMITED TO PURCHASE PRICE OF PRODUCT AND NEW BUCK SHALL NOT BE LIABLE FOR ANY OTHER DAMAGES WHATSOEVER INCLUDING INCIDENTAL OR CONSEQUENTIAL DAMAGES.**

Some states do not allow a limitation on how long an implied warranty lasts or an exclusion or limitation of incidental or consequential damages so above limitation on implied warranties or exclusion on damages may not apply to you.

This warranty gives you specific legal rights. Other rights may vary from state to state.





## OWNER REGISTRATION

The attached owner registration card must be completed in its entirety and mailed within 30 days from date of installation in order for warranty coverage to begin to:

New Buck Corporation  
P.O. Box 69  
Spruce Pine, NC 28777  
Email: info@buckstove.com

\* You have the option to also scan and email this page to email listed above.

PLEASE NOTE: Owner Registration Card must contain Authorized Buck Stove Dealer Number and Certified Installer's number (if applicable) for warranty coverage to begin.

**NAME:** \_\_\_\_\_

**ADDRESS:** \_\_\_\_\_

**CITY:** \_\_\_\_\_

**STATE:** \_\_\_\_\_ **ZIP:** \_\_\_\_\_

**MODEL #:** 34 CONTEMPORARY **SERIAL #:** \_\_\_\_\_

**DATE OF INSTALLATION:** \_\_\_\_\_

**INSTALLER'S NAME:** \_\_\_\_\_

**PURCHASED FROM:** \_\_\_\_\_