

# 10' x 20' MAX AP CANOPY Assembly Instructions

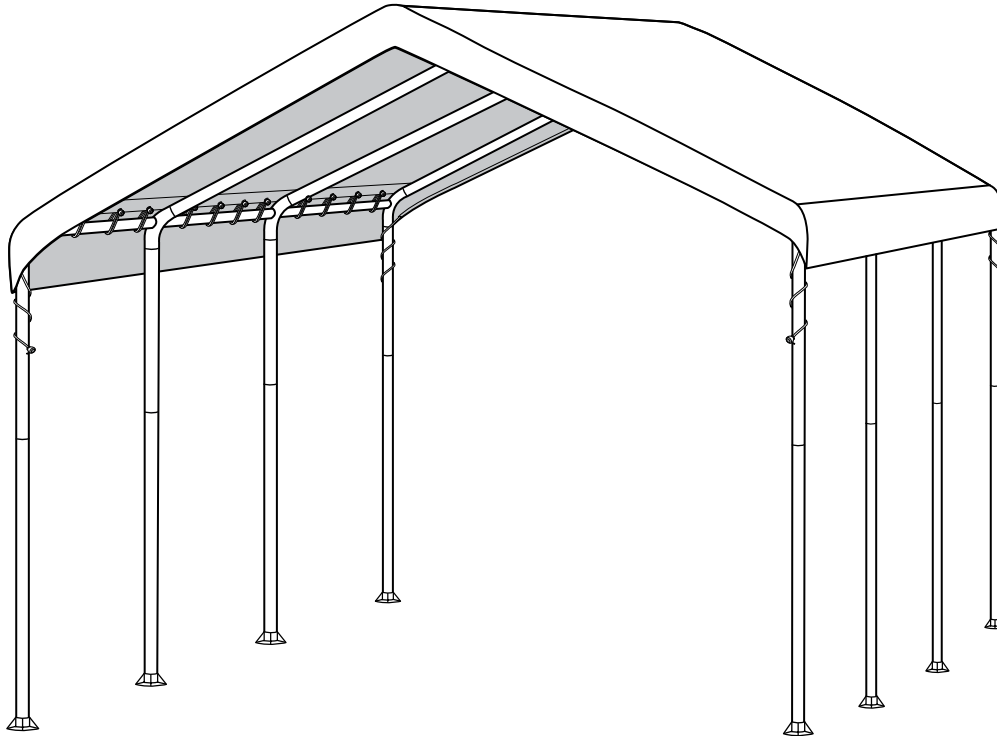

DESCRIPTION	MODEL #
10' x 20' MAX AP Canopy - 8 Leg - White	23522

## RECOMMENDED TOOLS

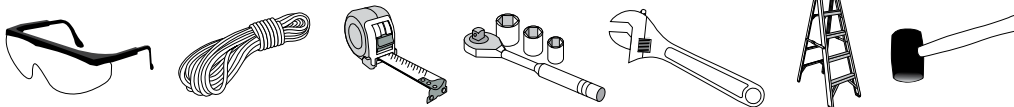

Please read instructions **COMPLETELY** before assembly. This shelter **MUST** be securely anchored. **THIS IS A TEMPORARY STRUCTURE AND NOT RECOMMENDED AS A PERMANENT STRUCTURE.**

Before you start: 2+ individual recommended for assembly, approximate time 2 hr.



150 Callender Road  
Watertown, CT 06795  
www.shelterlogic.com

**1-800-524-9970**

Canada:  
**1-800-559-6175**

## ATTENTION:

This shelter product is manufactured with quality materials. It is designed to fit the **ShelterLogic®**, LLC custom fabric cover included. **ShelterLogic®**, LLC Shelters offer storage and protection from damage caused by sun, light rain, tree sap and animal - bird excrement. Please anchor this **ShelterLogic®**, LLC structure properly. See manual for more anchoring details. Proper anchoring, keeping cover tight and free of snow and debris is the responsibility of the consumer. This shelter is not recommended for severe weather conditions. Please read and understand the installation detail, warnings and cautions prior to beginning installation. If you have any questions call the customer service number listed below. Please refer to the warranty card inside this package.

## DANGER:

Prior to installation, consult with all local municipal codes regarding installation of temporary shelters. Choose the location of your shelter carefully. **DANGER: Keep away from electrical wires.** Check for overhead utility lines, tree branches or other structures. Check for underground pipes or wires before you dig. DO NOT install near roof lines or other structures that could shed debris onto your shelter. DO NOT hang objects from the roof or support cables.



## WARNING:

Risk of fire. DO NOT smoke or use open flame devices (including grills, fire pits, deep fryers, smokers or lanterns) in or around the shelter. DO NOT store flammable liquids (gasoline, kerosene, propane, etc.) in or around your shelter. Do not expose top or sides of the shelter to open fire or other flame source.

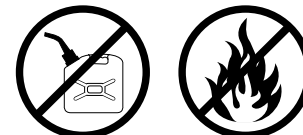

## CAUTION:

Use **CAUTION** when erecting the frame. Use safety goggles during installation. Secure and bolt together overhead poles during assembly. Beware of pole ends.

## PROPER ANCHORING AND INSTALLATION OF FRAME:

### PROPER ANCHORING OF THE FRAME IS THE RESPONSIBILITY OF THE CONSUMER.

**ShelterLogic®**, LLC is not responsible for damage to the unit or the contents from acts of nature. Any shelter that is not anchored securely has the potential to fly away causing damage, and is not covered under the warranty. Periodically check the anchors to ensure stability of shelter. **ShelterLogic®**, LLC cannot be responsible for any shelter that blows away. **NOTE:** *Your shelter's cover can be quickly removed and stored prior to severe weather conditions.* If strong winds or severe weather is forecast in your area, we recommend removal of cover.

## REPLACEMENT PARTS, ASSEMBLY, SPECIAL ORDERS:

Genuine **ShelterLogic®**, LLC replacement parts and accessories are available from the factory, including anchoring kits for nearly any application, replacement covers, wall and enclosure kits, vent and light kits, frame parts, zippered doors and other accessories. All items are shipped factory direct to your door.

### QUESTIONS - CLAIMS - SPECIAL ORDERS? CALL OUR CUSTOMER SERVICE HOTLINE:

U.S. CUSTOMER SERVICE: 1-800-524-9970 INTERNATIONAL CUSTOMER SERVICE: 001-860-945-6442 CANADA CUSTOMER SERVICE: 1-800-559-6175

HOURS OF OPERATION: MON-FRI 8:30AM-8:00PM EST, SAT-SUN 8:30AM-5:00PM EST.

## CARE AND CLEANING:

A tight cover ensures longer life and performance. Always maintain a tight cover. Loose fabric can accelerate deterioration of cover fabric. Immediately remove any accumulated debris from the roof structure with a broom, mop or other soft-sided instrument. Use extreme caution when removing debris from cover- always remove from outside the structure. DO NOT use hard-edged tools or instruments like rakes or shovels to remove debris. This could result in punctures to the cover. DO NOT use bleach or harsh abrasive products to clean the fabric cover. Cover is easily cleaned with mild soap and water.

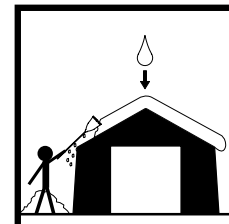







## WARRANTY:

This shelter carries a full limited warranty against defects in workmanship. **ShelterLogic®**, LLC warrants to the Original Purchaser that if properly used and installed, the product and all associated parts, are free from manufacturer's defects for a period of:

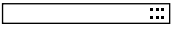
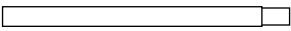
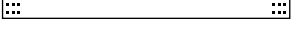
### 1 YEAR FOR COVER FABRIC, END PANELS AND FRAMEWORK

Warranty period is determined by date of shipment from **ShelterLogic®**, LLC for factory direct purchases or date of purchase from an authorized reseller, (please save a copy of your purchase receipt). If this product or any associated parts are found to be defective or missing at the time of receipt, **ShelterLogic®**, LLC will repair or replace, at it's option, the defective parts at no charge to the original purchaser. Replacement parts or repaired parts shall be covered for the remainder of the Original Limited Warranty Period. All shipping costs will be the responsibility of the customer. Parts and replacements will be sent C.O.D. You must save the original packaging materials for shipment back. If you purchased from a local dealer, all claims must have a copy of original receipt. After purchase, please fill out and return warranty card for product registration. Please see warranty card for more details.

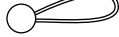
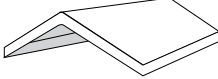
# 10' x 20' MAX AP Canopy - 8 Leg - Parts List - Model #23522

Description of Parts:	Quantity	Part #
 Rafter Poles, Swedge 24.4"	8	13104
 Poles, Swedge 40.7"	25	13103
 Cross Poles 39.5"	9	13107
 Leg Poles 39"	8	13105
 3 - Way Frame Connectors	6	13101
 4 - Way Frame Connectors	6	13102
 Bungee Cords	24	10066
 Canopy Cover	1	10072
 Base Feet	8	10075
 Anchors	8	10431

## 1. LAYOUT ROOF FRAME

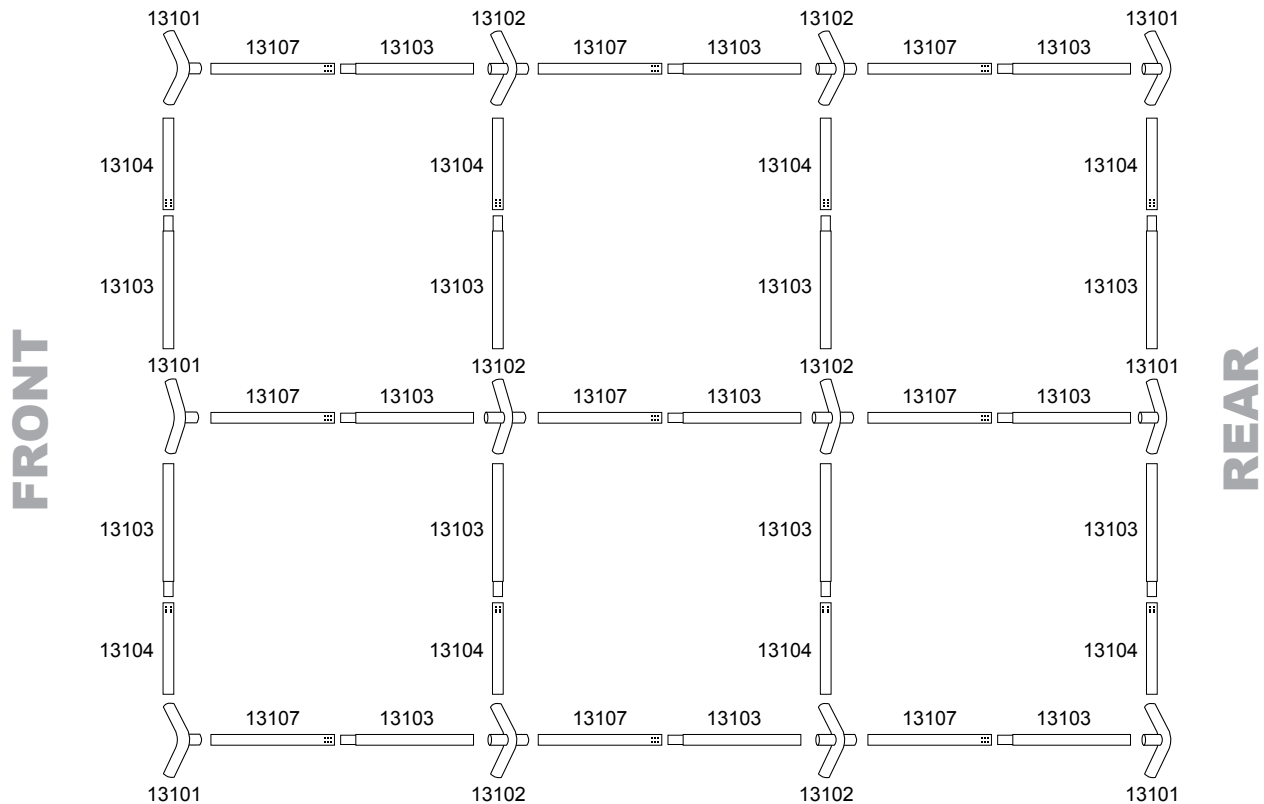

## 2. ASSEMBLE ROOF FRAME

**NOTE:** Swedged tubes insert into plain ends at the crimp marks.

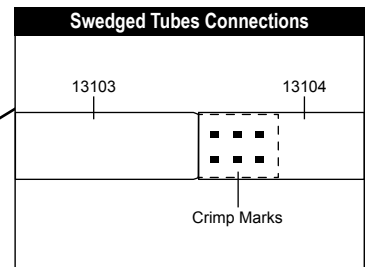
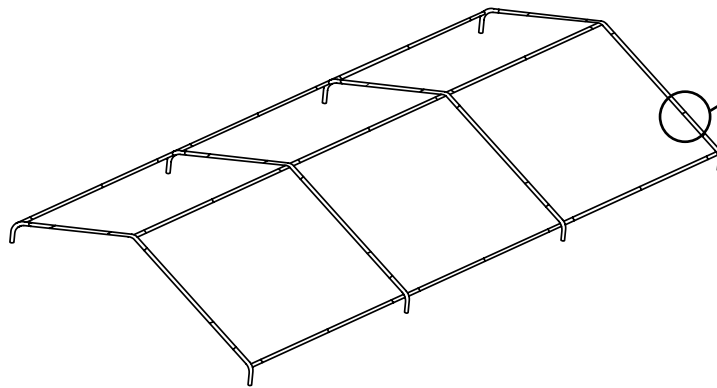

## 3. ASSEMBLE LEGS & ATTACH TO ROOF FRAME

**A.** Attach all legs to one side first. Let the other side of roof frame rest on the ground. Repeat for opposite side.

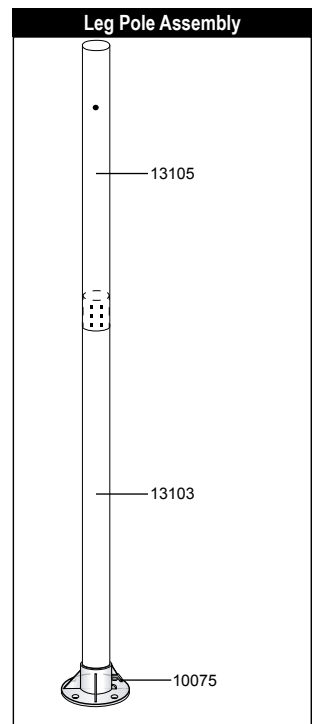
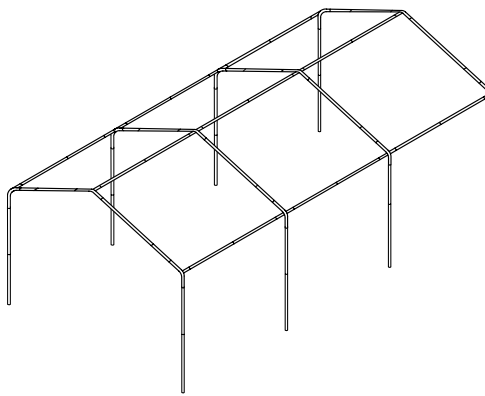
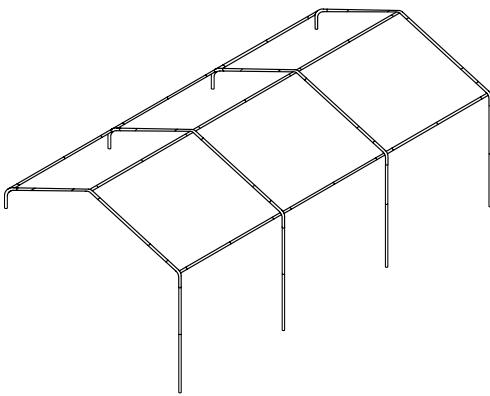

## 4. ANCHOR THE FRAME

*There are four holes on each base foot that the anchor can go into.*

**A.** Select a hole in each base foot. Insert each anchor (10431) into the ground until the round head is touching the base foot. These anchors prevent the canopy from shifting. Insert one anchor into all four base feet.

*This is a temporary spike anchor. Not intended for permanent use.*

**B.** To securely anchor canopy, Accessory Anchoring Kit #10073 is recommended. The 4-anchor pins are inserted into the ground. Then the ropes are tied from the anchors to the corner tees as shown in **B**.

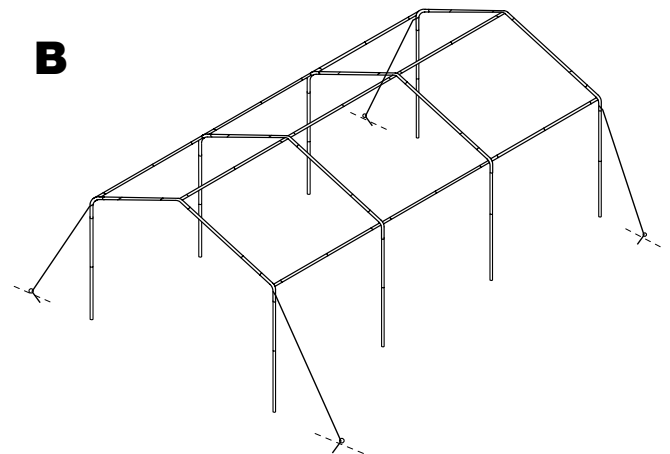
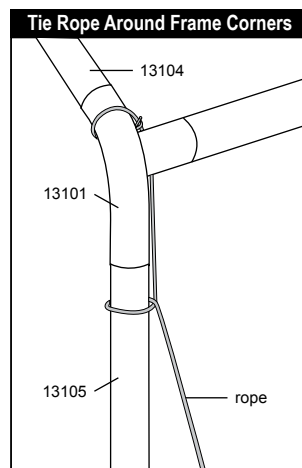
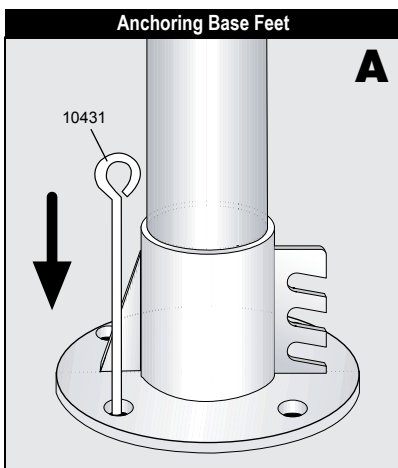

## 5. PLACE COVER AND SECURE TO CANOPY FRAME

- A. Place cover over assembled roof frame with grommet panels facing down, aligned with cross rails.
- B. Make sure the cover is properly aligned on the frame, secure the four corners of the cover with bungees (10066) to the frame first. Attach remaining bungees.

*Re-adjust bungees position along cross pole as needed to ensure a tight and even fit of the cover to the frame.*

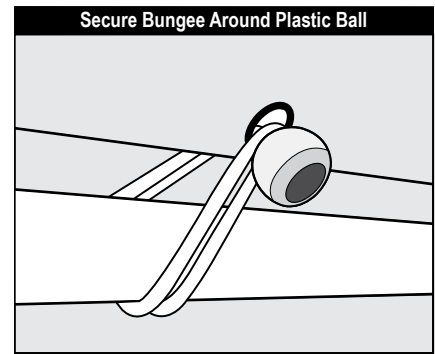
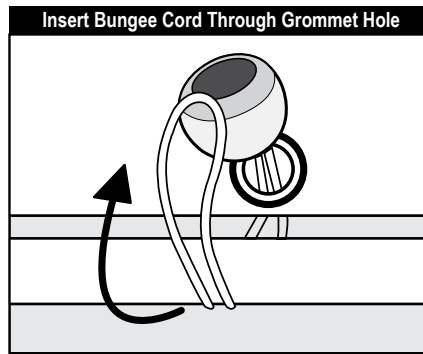
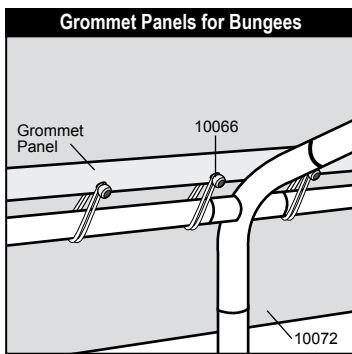
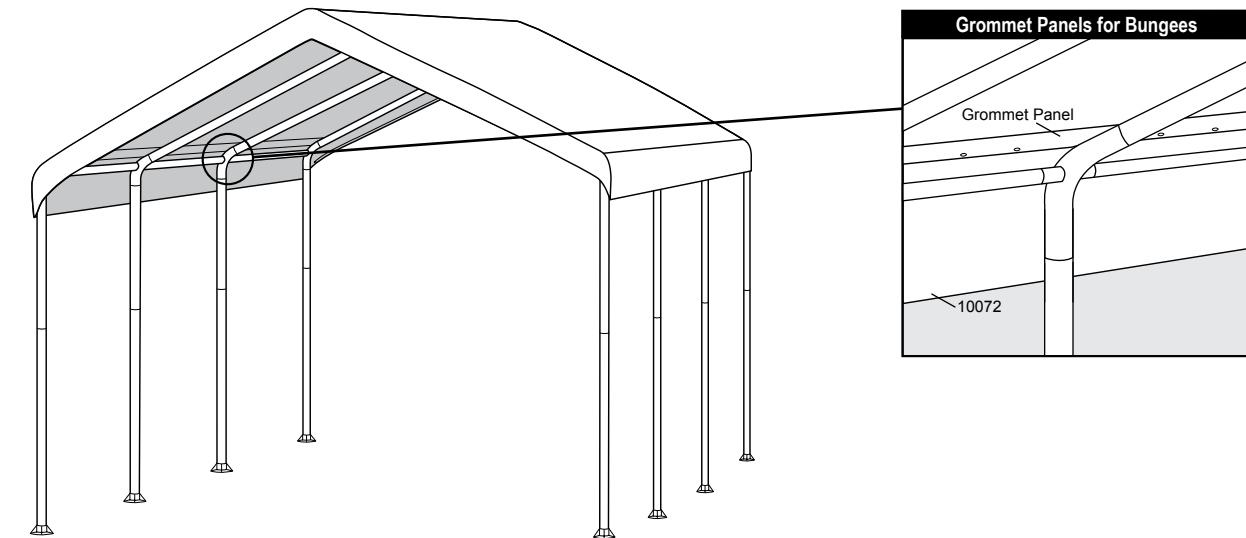

## 6. TIGHTEN THE COVER WITH TWIST TITE™

- A. Wrap the cord with plastic ball and "S" hook at the corners of the cover around the corner leg poles. Insert "S" hook into the hole of the corner leg poles.
- B. Twist each leg pole toward the inside of the shelter until the cover becomes tight. Twist the leg poles equally to ensure the cover stays aligned during tightening.

