



Hercules Snow Load™ 10ft X 20ft

10ft8in Wide x 20ft Deep x
6ft8in Side Height / 9ft6in Center Height



King Canopy Item #: HC1020PCSL

With 8 Legs, Cable Truss System, Cover, 4 Piece Zippered Side-Wall Kit (2 Side Panels with Windows, 1 Rear Solid Panel and 1 Front Panel with Zippers).











Distributed by:
PIC America, LTD.
1730 Five Points Lane • Fuquay-Varina, NC 27526
1-800-800-6296 • www.kingcanopy.com

WARNING:

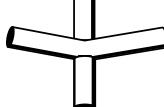
Keep all flame and heat sources away from this tent fabric. Meets the flammability requirements of CPAI-84 Section 6 and NFPA-701. It is not fire proof. The fabric will burn if left in continuous contact with any flame source.

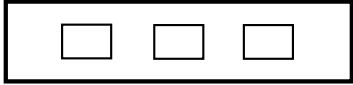
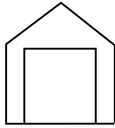
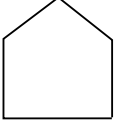
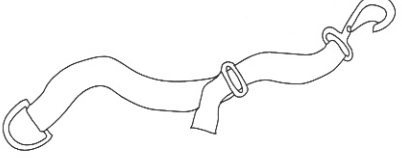

PARTS LIST

6X6-2PC	8 pc	78in pipes, 2in diameter	
6x6-15PC	9 pc	78in pipes, 1-1/2in diameter	
5X8-2PC	8 pc	68in pipes, 2in diameter	
3W215PC	6 pc	3-way connectors	
4W215PC	6 pc	4-way connectors	
BALLW100	100 pc	Elastic ball straps	
PFOOT2	8 pc	Foot pads	
PTCL1020FR6	1 pc	Cover	
T81020SWW-W	2 pc	Sidewalls with windows	
T81020EWZFR6	1 pc	Front wall with zippers	
T81020EWFR6	1 pc	End wall solid	
PTCL1020VS	1 pc	Valance tie downs (4 pack)	
SL1020C	1 pc	Four Snow Load Truss Cables	

FRAME ASSEMBLY



Step 1

Separate all pieces according to size and shape and arrange per the illustration shown below.

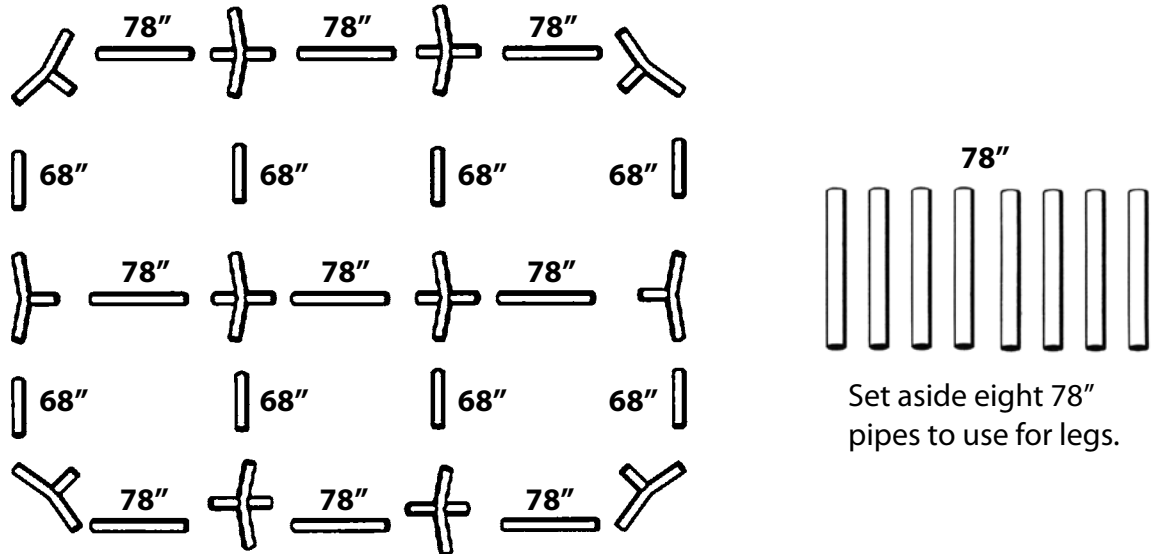

Please note:

- The 68in, 2 in diameter pipes are used to form the roof rafters
- The 78in, 1-1/2 in diameter pipes are used to form the roof perimeter
- The 78in, 2 in diameter pipes are used to form the legs of the unit

Step 2

As you are assembling the pipes of this unit, you will also need to begin installation of the Cable Truss System. To do so, place the large center loops of the Cable Truss System over each rafter peak 3-way connector and then attach rafter pipes to each connector.

With the rafter pipes (and attached cable truss system) lying on the ground, the small outer loops should be slipped over each piece of 78in 1-1/2in diameter pipe. Attach 3-way connectors at each end of the pipe and center the truss cable. Repeat on opposite side of the roof perimeter and for each of the perimeter pipes.



Step 3

Connect the remaining perimeter and rafter pipes together starting with the center of the frame, keeping the cable truss system centered on each section.

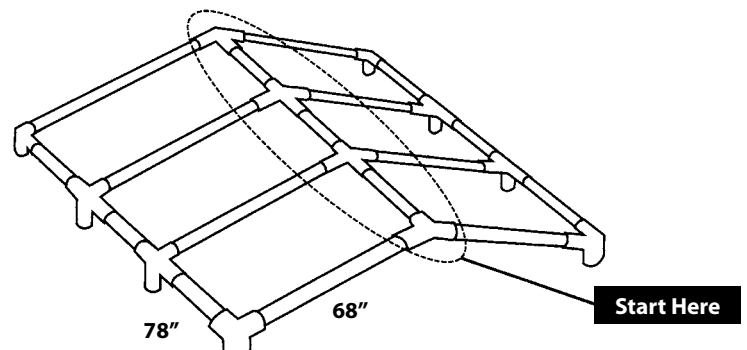

DO NOT CONNECT LEG POLES AT THIS POINT!



COVER ASSEMBLY

Step 1

Unfold the cover with the grommets toward the cover's bottom and place over the frame. The flared edges should be located at each of the 4 corners of the frame.

Step 2

Begin attaching the cover with the elastic ball straps by inserting the elastic cord of the ball strap underneath the cover and through the grommet. Then pull cord taut until ball stops. Wrap the cord around the pole and under the ball. This will hide the ball under the cover and provide a more finished look to your unit.

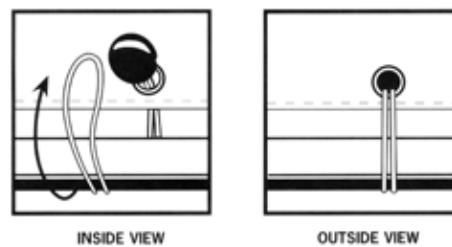

- Start by attaching 2 elastic ball straps at each of the four corners
- Continue attaching straps from left to right in a zigzag pattern down both sides of the canopy
- Attach straps at the front and back of the unit, again using a zigzag pattern until all straps are secured

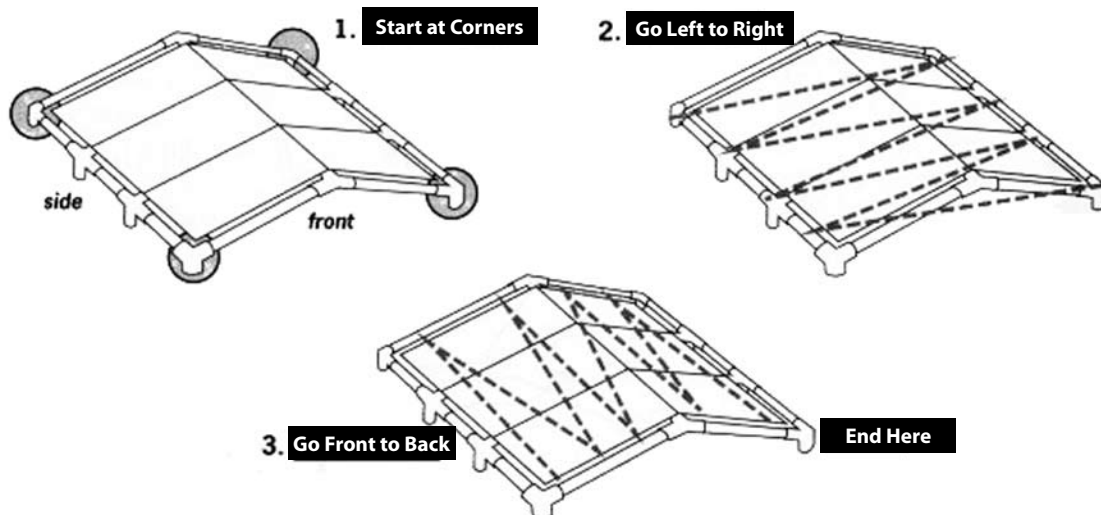

Note:

The ball straps are long enough to accommodate various cover lengths. If your straps need a tighter fit, they can be shortened by making an additional knot in the cord strap.

Slide the ball upward to reveal the tied knot.

Tie a new knot above the old one. The size of the knot will determine how short the strap becomes. Slip the ball down over the new knot and secure.

DO NOT CONNECT LEG POLES AT THIS POINT!

WALLS AND LEGS ASSEMBLY



Step 1

Unfold each of the walls.

- The back wall (solid) and front wall (with zippers)
- The side walls of the unit feature 3 windows each

Step 2

Find the hook & loop fastening strips on one length of the first sidewall to be assembled. These strips are to be placed on the top pipe of your canopy structure by wrapping the fastening strips over the perimeter poles. Repeat with second side wall, rear wall and front wall.

Note:

You may attach the side and rear walls with the window shades facing either the inside or outside of the unit. They are designed to be assembled either way.

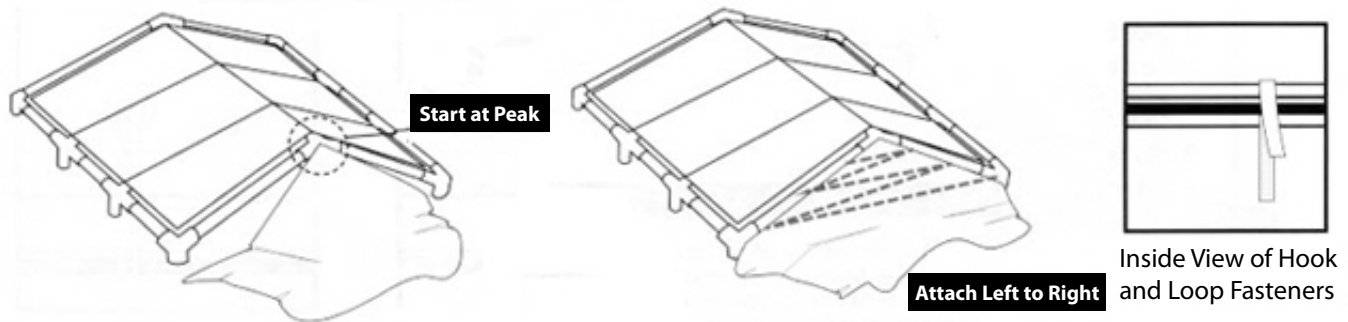

NOW, CONNECT THE LEG POLES TO THE ROOF ASSEMBLY WITH THE COVER ALREADY POSITIONED ON TOP OF THE UNIT.

Step A: First insert the pipes for the middle poles into the 3- and 4-way connectors, and then connect the end leg pipes in the same way. (See illustration)

Step B: Push the eight foot pads onto the bottom of each leg.
NOTE: the foot pads are NOT for anchoring the canopy!

Step C: Connect the hook & loop fastening strips down the length of each leg.

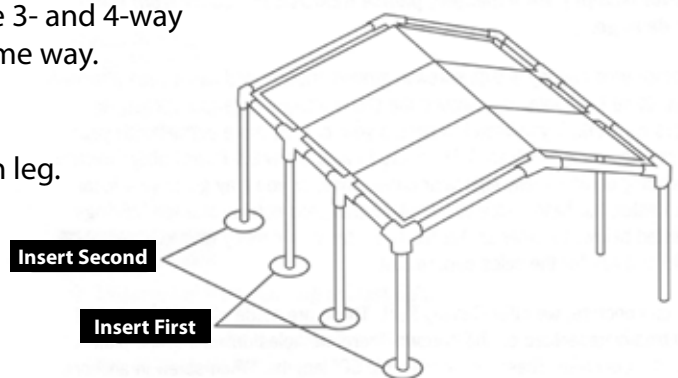

Step 3

After connecting the top of the side walls and installing the leg pipes into the connectors on the perimeter of the unit, use elastic ball straps to connect the end of each sidewall to the 4 corners of the unit.

IMPORTANT! Once the legs and cover are assembled, your canopy will act like a kite in the wind. It is imperative that the canopy anchors be installed NOW!



INSTALLING THE LEG SKIRTS

Step 1

After the legs have been connected to the roof using the 3- and 4-way connectors and your canopy has been securely anchored, attach the leg skirts using elastic ball straps and the grommets at the top of the unit. (Make sure that the end walls are underneath the flared leg covers to minimize rain and other elements from entering inside the canopy unit.)

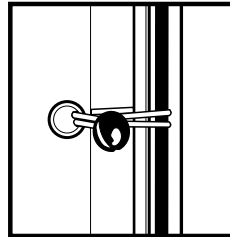

Step 2

Next secure the flared leg covers over the 4 corners (and outside the walls) by fastening the fabric loops located at the bottom of each leg skirt over the flanged clip on the foot pads.

FINISH ASSEMBLY OF YOUR CANOPY

To complete the assembly and securing of your unit, finish installing elastic ball straps completely around the unit at the top and bottom wherever there is a grommet. Ball straps at the bottom of each side panel should be attached to the flanged clip on the foot pads.

Lastly, attach the 4 valance tie downs from the top grommet to the bottom grommets, securing to the foot pads using the clips on end of the straps.

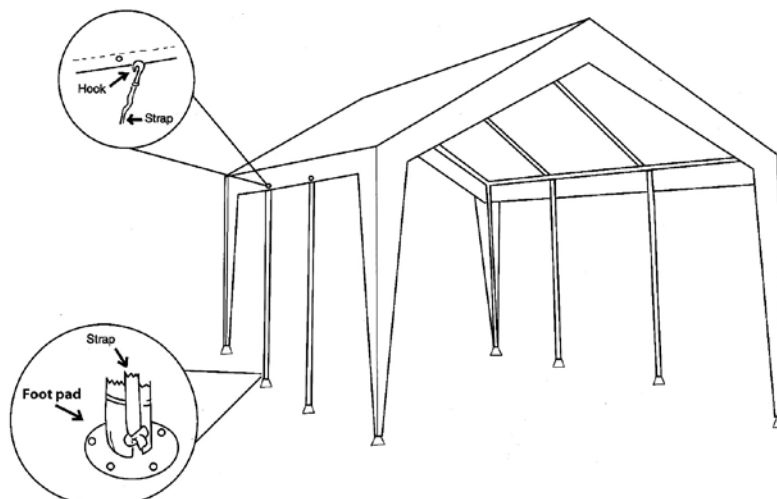

ANCHORING YOUR UNIT



This canopy is designed for use as a temporary structure. After assembly, the canopy **MUST BE** securely anchored to the ground to prevent damage from winds. Your canopy will act like a kite in the wind if not properly and securely anchored to the ground. Severe winds will cause the frame to twist and unanchored legs will fall, thereby collapsing the canopy. If severe winds are expected, you must remove the cover from the frame to prevent damage.

Step 1

Measure out at least 36in from each leg. Screw each anchor into the ground leaving 2in between the ground and the eye of each anchor. We strongly recommend that your unit be anchored 36in from each leg although this may not be possible in all cases. **DO** install anchors as close to 36in away from legs as possible.

Step 2

Tie anchor cable or rope around the connector at the top of each leg of the canopy.

Step 3

Securely tie the other end of the cable or rope through the eye of the anchor and pull tight.

Step 4

Now, continue to screw each anchor into the ground until the eye of the anchor is flush with the ground. This will secure the anchor rope even tighter.

NOTE: You should check and tighten the rope frequently to ensure maximum stability of your canopy and to protect against wind damage.

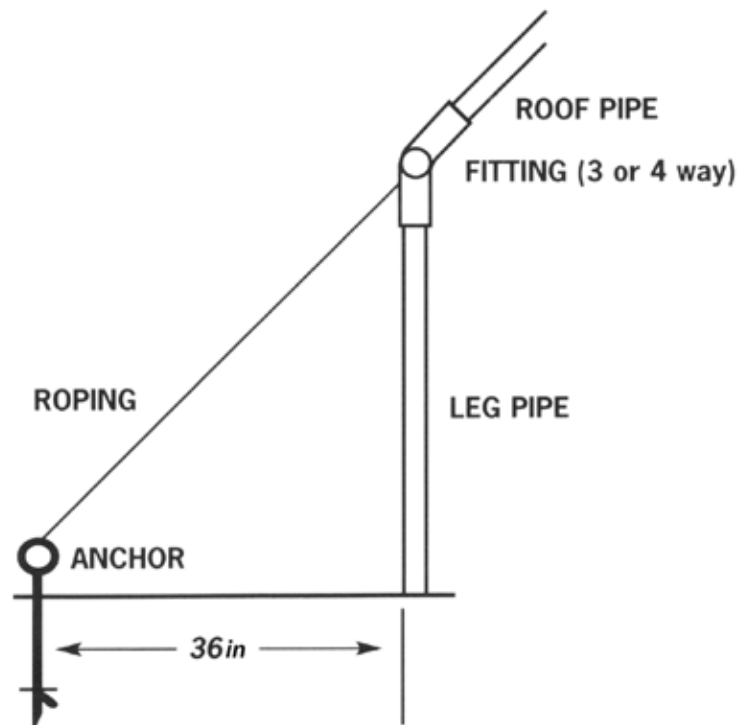



IMPORTANT NOTICE: PLEASE READ CAREFULLY

We are confident that you will be completely satisfied with your King Canopy unit. Please take a moment to read the very important information below, and call us with any questions you may have.

King Canopy/PIC America, LTD. has no control over wind, snow, ice, rain or any other weather condition and we are in no way responsible for any damage caused by the canopy or to the canopy. We suggest you contact your insurance carrier just as you would for any other outside structure.

OTHER PRECAUTIONS WHICH MUST BE FOLLOWED:

Keep all flame and heat sources away from this tent fabric. The tent fabric will burn if left in continuous contact with any flame source.

DO NOT cook underneath or near canopy.

DO NOT store or use flammable liquids underneath or near canopy.

DO NOT ignite or store fireworks underneath or near canopy.

DO NOT use bleach to clean cover.

DO NOT dry clean cover.

DO NOT wash cover in washing machine or dry in dryer. Hand wash with mild soap and water only.

DO NOT allow rain water, snow or ice to accumulate on top of cover.

DO NOT hang or suspend anything from the frame, grommets, truss system or ball straps of the unit.

REMOVE canopy cover before a storm, or disassemble entire canopy unit if possible.

REMOVE rain water, snow and ice from canopy cover.

This is a temporary structure and is not recommended for use as a permanent structure.

PRODUCT INFORMATION



Defective Parts

We try our best to eliminate any defective parts that are shipped with our products. If, however, you should find a defective part, we will replace – free of charge – any part which is defective. You will need to provide proof of purchase showing date of purchase and provide us with detailed description of the defective component. Your replacement will be shipped by ground shipping, freight prepaid. Next day or express shipping will require freight collect and paid for by you, the consumer. Damages from improper anchoring, strong winds, snow, ice or rain are not considered defects.

Improper Anchoring, Strong Winds, Rain Snow, or Ice

King Canopy/PIC America, LTD. does not guarantee these canopies under strong weather conditions. These canopies are designed to protect against damages caused by sun, rain, tree sap, birds, etc. They are not designed to hold roof loads that accompany snow, ice or heavy rains. If your canopy is not anchored securely, it can be lifted by the wind and will fly away. If your canopy takes flight, we are not responsible for any replacement. If you know strong weather is predicted, remove the cover or take down the canopy unit completely. The cover is designed to be quickly and easily removed.

Warranty

All components of this canopy feature a 1-year limited warranty and are warranted to be free from defects in material and workmanship for a period of 1-year. You must complete and return the enclosed warranty card promptly after purchase. Please retain your proof of purchase receipt; you will be asked to provide this receipt in order to obtain warranty service.

Non-Warranty Replacement Parts

If after expiration of the warranty period, you require replacement parts please contact us at 1-800-800-6296. We stock replacement parts and make them available to you at discounted prices. Our customer service department will be pleased to assist you in any way possible.

Certain regions of the country are extremely hard on covers of any kind. Normal wear and tear is not covered under the warranty, and should be expected.

In order to receive a discounted or free replacement part, you may be asked to return the part, freight prepaid, to our warehouse for inspection before we will send a replacement. You must, in all cases, provide a copy of your receipt showing the date of purchase, model number and price.

For missing parts, replacement parts or any questions:

Please Call 8:00am – 5:00pm EST, Monday –Friday

1-800-800-6296 or 1-919-552-2977

Or you can fax us at: **1-919-552-5069**

Replacement parts and customer service is also available through our website.

Please visit us at **www.kingcanopy.com**