

MARKS

Metro Entrance Mortise Locksets

114 Series

Specifications

- Thru-bolted knob/plate assemblies integrate and align with lock body. Standard Finish: US 3
- Exterior: Wrought brass, screwless round knob, 2-1/4" diameter on steel reinforced brass plate, 10" x 2-3/4". Two thru posts pass thru lock body. Integral spring-loaded 9/32" spindle.
- Interior: Wrought brass, screwless round knob, 2-1/4" diameter on steel reinforced brass plate, 7" x 2-1/4". Exposed 8-32 mounting. Bolts engage outside plate assembly. Integral spring-loaded 9/32" spindle.
- Cylinder: 5-pin cylinder, 1-1/8" long
- Strike: Conforms to ANSI spec. A115.1, 4-7/8" x 1-1/4" x 3/32" thick, 5/8" curved lip
- Door Thickness: 1-1/4" to 1-3/4"
- Backset: 2-1/2"
- Lock Front: 7-5/8" x 1-1/16", .187" thick, flat or 3° bevel, solid brass. Optional front: 8" x 1-1/4" steel backplate with brass cover plate.
- Deadbolt: Cast brass, 1" throw
- Latch: Solid brass, 1/2" throw, reversible
- Rocker Switch: Locks or unlocks hub
- Hubs: 9/32" on square with steel security separator
- Hub Lock Arm: Steel, .125" thick
- Case: High pressure cast Zamac, baked enamel finish

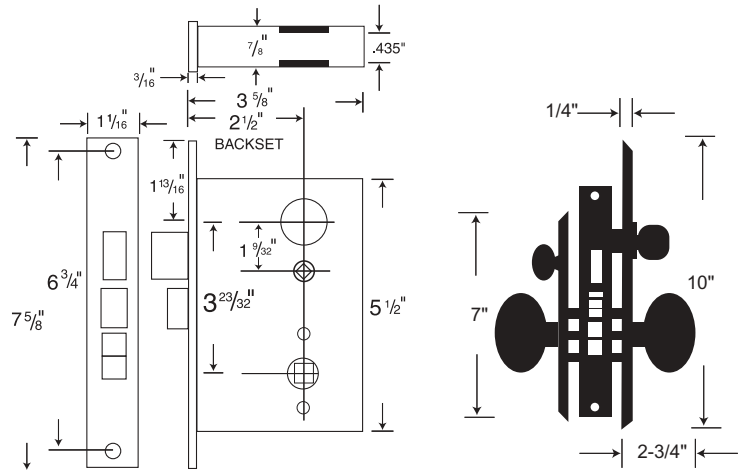
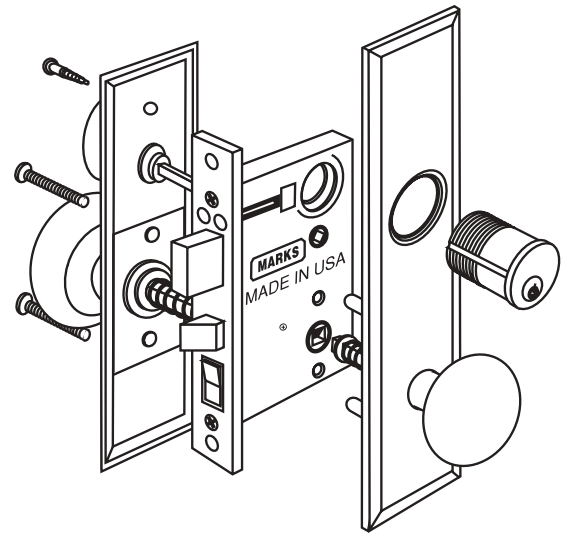

NOTE:

This series lockset is not UL listed and should not be used on fire doors. Using non-UL listed hardware on fire doors violates building code, life safety code and NFPA80. This lock is only to be used for non-fire rated applications. Other restrictions do apply. Always check your local building codes and get final approval from the local AHJ (Authority Having Jurisdiction).

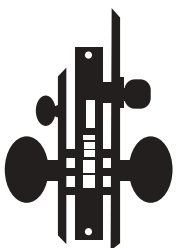

A Entrance

Latch by knob either side except when locked by stop-button; then by key outside, knob inside. Deadbolt by key outside; handpiece inside.

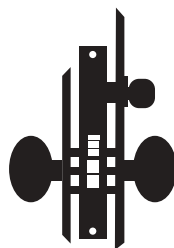

D Office Vestibule

Latch by knob either side except when outside knob locked by stopbutton in front, then by key outside.

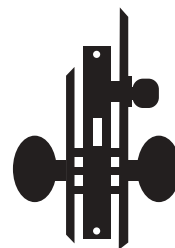

DW Vestibule

Latch by knob inside, key outside. Outside knob always rigid.













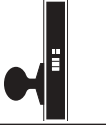
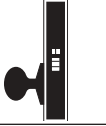

Single Cylinder Functions

INSIDE	OUTSIDE	FUNCTION	TYPE	ANSI NO.	FUNCTION DESCRIPTION
		E	Office	F04	Latch by knob either side except when outside knob locked by stop button in front; then by key outside. Auxiliary latch deadlocks latch. Inside always open.
		J	Classroom	F05	Latch by knob either side except when outside knob locked by key. When locked, latch bolt retracted by key. Inside always open. Auxiliary latch deadlocks latch when locked.
		JM	Hospital	F06	Latch by knob either side except when outside knob locked or unlocked by key. Auxiliary latch deadlocks latch. Inside always open. Latch bolt can be locked in retracted position.
		EW	Storeroom	F07	Latch by knob inside, key outside. Outside knob always rigid. Auxiliary latch deadlocks latch. Inside always open.
		A	Entrance	F08, F10	Latch by knob either side except when outside locked by stopbutton; then by key outside, knob inside. Deadbolt by key outside, turnpiece inside. Deadbolt deadlocks latch.
		F	Dormitory	F12	Latch by knob either side except when outside knob locked by stopbutton or projected deadbolt. Deadbolt by turnpiece inside. Inside knob retracts latch and deadbolt simultaneously, leaving outside locked. Deadbolt deadlocks latch.
		FW	Dormitory	F13	Latch by knob either side except when projected deadbolt locks outside knob and deadlocks latch. Deadbolt and latch by key outside. Deadbolt by turnpiece inside. Inside knob retracts latch and deadbolt simultaneously, automatically unlocking outside knob.
		H	Hotel	F15	Inside knob always free, outside rigid. Latch by knob inside, key outside. (When deadbolt projected by turnpiece all keys are shut out except emergency key). Inside knob retracts deadbolt and latch simultaneously. Auxiliary latch or deadbolt deadlocks latch. Indicator available.
		FD	Apartment	F20	Latch by knob either side except when outside locked by stop button or projected deadbolt. Latch deadlocked by auxiliary latch or deadbolt. Deadbolt and latch by key outside. Deadbolt by turnpiece inside. Inside knob retracts latch & deadbolt simultaneously, leaving outside locked.
		B	Entrance	F21	Latch by knob either side. Deadbolt by key outside, turnpiece inside. Deadbolt deadlocks latch.

















MARKS

Functions

Single Cylinder Functions

INSIDE	OUTSIDE	FUNCTION	TYPE	ANSI NO.	FUNCTION DESCRIPTION
		GL	Institutional Privacy	F26	Latch by knob either side except when outside knob locked by inside thumbturn. Latch deadlocked by auxiliary latch. Key outside opens latch. When outside locked, inside knob retracts latch, automatically unlocking outside knob.
		EX	Exit	F31	Latch by knob inside, non-removable blank trim or no trim outside. Auxiliary latch, dead locks latch.
		FC	Intruder Deadbolt	F34	Latch by knob either side. Deadbolt by key either side. Inside knob retracts latch and deadbolt simultaneously, automatically unlocking outside knob. Auxiliary latch deadlocks latch.
		BW	Entrance	—	Latch by knob inside. Outside knob always rigid. Deadbolt and latch by key outside. Deadbolt by turnpiece inside. Deadbolt deadlocks latch.
		D	Office Vestibule	—	Latch by knob either side except when outside knob locked by stopbutton in front; then by key outside.
		DW	Vestibule	—	Latch by knob inside, key outside. Outside knob always rigid.
		FS	Dormitory	—	Latch by knob inside. Outside knob always rigid. Deadbolt and latch by key outside. Turnpiece retracts deadbolt. When deadbolt is projected, latch is deadlocked. Inside knob retracts latch and deadbolt simultaneously.
		LH	Special Privacy	—	Inside knob always free, outside rigid. Latch by knob inside, key outside. Deadbolt by turnpiece inside, emergency release outside. Inside knob retracts deadbolt and latch simultaneously. Auxiliary latch deadlocks latch.



Double Cylinder Functions

INSIDE	OUTSIDE	FUNCTION	TYPE	ANSI NO.	FUNCTION DESCRIPTION
		G	Entrance	F09	Latch by knob either side except when outside knob locked by key inside, then by key outside. Auxiliary latch deadlocks latch.
		FA	Dormitory	F11	Latch by knob either side except when outside knob locked by stopbutton or projected deadbolt. Deadbolt by key either side. Inside knob retracts latch and deadbolt simultaneously, leaving outside locked. Deadbolt deadlocks latch.
		C	Storeroom	F14	Latch by knob either side. Deadbolt by key either side. Deadbolt deadlocks latch.
		AC	Entrance	F35	Latch by knob either side except when outside knob locked by stopbutton in front; then by key outside. Deadbolt by key ether side. Deadbolt deadlocks latch.
		GC	Intruder Latch Bolt	F32	Latch by knob either side except when outside knob is locked from inside or outside by key. Latch operated by key from inside or outside. Auxiliary latch, deadlocks latch. Inside always open.
		FX	Dormitory	F33	Latch by knob either side except when projected deadbolt locks outside knob and deadlocks latch. Deadbolt and latch by key either side. Inside knob retracts latch and deadbolt simultaneously, automatically unlocking outside knob.
		SO	Storeroom	F24	Latch by thumbpiece either side except when outside thumbpiece locked by stop-button in front; then by key outside. Deadbolt by key both sides. Deadbolt deadlocks latch.
		WW	Institution	F30	Both knobs rigid. Auxiliary latch deadlocks latch. Latch by key either side.

MARKS

Functions

Non-Keyed Functions

INSIDE	OUTSIDE	FUNCTION	TYPE	ANSI NO.	FUNCTION DESCRIPTION
		N	Passage	F01	Latch by knob either side.
		L	Bathroom	F02	Latch by knob either side. Deadbolt by turnpiece inside, emergency release outside. Deadbolt deadlocks latch.
		LF	Privacy	F19	Latch by knob either side except when projected deadbolt locks outside knob and deadlocks latch. Deadbolt by turnpiece inside, emergency release outside. Inside knob retracts latch and deadbolt simultaneously, automatically unlocking outside knob.