

ATRplus

White paper



October 2015

David Grimm, Gerhard Kleemaier, Hans-Martin Zogg

Leica Geosystems AG

Heerbrugg, Switzerland

Abstract

The new automatic target recognition – ATRplus – and the new intuitive field software Leica Capivate significantly increase the automation performance of the Leica Viva and Leica Nova total stations and MultiStations. ATRplus enables the entrance into a new dimension of measurement experience.

Dynamic laser energy control, history logs of the reflected laser spots and a reliable detection of foreign reflections are examples of the automation technology in ATRplus. ATRplus is integrated in the latest generation of total stations (TS16 / TS60) and MultiStations (MS60).

Introduction

With previous generations of total stations, the measurement professional who operates the instrument has to consider environmental conditions to achieve the best results. The user has to correctly set the visibility settings, high dynamics at short ranges, and lock in on the fly. However, environmental conditions can change during the measurement period and many combinations of the various settings exist.

To increase user comfort and reduce the complexity of the system, which are potential sources of errors caused by applying wrong settings, ATRplus simplifies handling of the total stations and MultiStations.

ATRplus with a dynamic and automatic energy control and new algorithms can automatically find the optimal parameters in challenging and changing environmental surroundings. This function results in higher measurement ranges for any conditions without changing the settings manually.

Besides the increased measurement performance on static targets, ATRplus has also been optimized on dynamically moving targets. When the target moves, the visibility and environmental conditions can change. A reliable detection of reflections from the sun and other sources is a must when following a target. The new image processing of ATRplus can detect such foreign “spots” as non-targets.

The velocity of the moving prism relative to the instrument has a great impact on the ability to reliably follow a prism. To follow a highly dynamic

moving prism with stability, a tight control loop in combination with better temporal measurement synchronisation was developed for the latest generation of total stations and MultiStations. ATRplus allows faster changes of the prism’s moving direction without losing it.

Search – Lock – Re-Lock

The automation cycle describes the relevant automation aspects of Search, Lock, and Re-Lock when following a prism for total stations and MultiStations. The automation starts with the search of the prism and continuously locks on it. When locked on the prism, ATRplus continuously measures the distance and delivers 3D positions of the prism. Nevertheless, ATRplus may lose the prism, perhaps through the interruption of the line of sight. Therefore, it is important to re-lock onto the prism as soon as the line of sight is restored (see Figure 1).

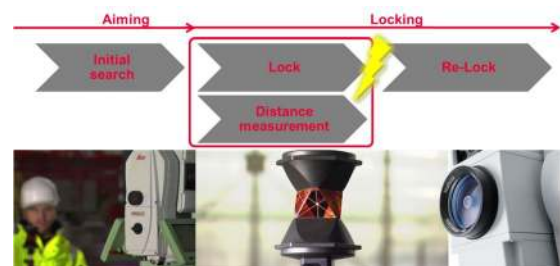

Figure 1 - Automation cycle with Search, Lock, and Re-Lock.

ATRplus plays a dominant role in the whole automation cycle. For high measurement productivity, it is crucial that the uptime – the time the instrument is following the prism and measuring the distance – is as long as possible.

ATRplus

ATRplus is based on Leica Geosystems’ existing ATR (Stempfhuber and Kirschner, 2008). The emitting part of ATRplus consists of a laser source that emits an infrared laser beam (IR) coaxially, with a divergence of 1.5 gon through the telescope. When the laser beam hits a prism, the beam reflects back into the telescope. A beam splitter, which is located in the optical axis of the telescope, decouples the beam from the optical path and guides the light through an IR band pass filter onto the CMOS sensor. On the CMOS sensor, the reflected laser beam appears as a light spot. Different algorithms evaluate the image data, identify the prism spot, and calculate

the pixel coordinates of the spot centre with sub pixel accuracy. With these pixel coordinates, ATRplus calculates the deviations of the spot centre from the centre of the optical axis. Combining the deviations with the angular and inclination sensor values, the final horizontal direction and vertical angle are calculated.

Detection of the Laser Spot on the CMOS sensor

To calculate the pixel coordinates of the laser spot, the CMOS sensor must detect the spot with good quality. To achieve a good quality, the energy must be set correctly. The energy is the product of the emitted laser power and the integration time on the CMOS sensor. Too much energy leads to an overexposure of the image. When using too low energy, the spot may not be visible on the CMOS at all. The correct energy level depends on the distance and on the meteorological conditions between the instrument and the prism.

ATRplus detects the reflected laser light as a laser spot on the CMOS sensor.

At the time of ATRplus measurement, neither the distance nor the meteorological conditions between the instrument and the prism are known. Furthermore, an EDM measurement is not possible at this stage because the field of view of the EDM is much smaller than the field of view of ATRplus. This means, an EDM measurement can only be done when the instrument is sufficiently aligned towards the prism. Here again ATRplus is needed.

Dynamic Energy Control of ATRplus

ATRplus continuously adjusts the energy to achieve an optimal brightness of the laser spot on the CMOS sensor. To find the correct energy settings, different steps are necessary. In the first step, the required integration time for the current visibility and distance conditions is calculated based on the maximum laser power. In the second step, ATRplus verifies if the resulting integration time is within the allowed emission time for the laser. If the maximal time is exceeded, ATRplus uses the analogue gain to enable a shorter integration time and the required integration time is recalculated. If the spot is too bright, the energy is reduced. The analogue gain is disabled first (if used), then the integration time is decreased, and finally the laser power is

reduced. The dynamic energy control of ATRplus leads to a better measuring performance under both harsh and good conditions.

ATRplus recognises and considers the range and visibility of the target through dynamic energy control.

ATR estimates the distance between instrument and prism by the size of the spot. However, adjusting the energy level based on the distance only does not take into account the variable visibility conditions. Foggy and rainy conditions would require a higher energy level than good visibility at the same distance. In contrast to ATR, ATRplus considers both the distance and the visibility conditions.

Detection of Reflections on Non-Relevant Targets

Non-relevant targets such as reflective clothing have to be considered for the dynamic energy control of ATRplus. If a reflective surface is clean and oriented more or less perpendicular towards the instrument, its surface can reflect the laser beam back into the instrument. Such reflections do not have the same brightness as a prism spot. However, they can appear similar to a wet prism that is far away. In this case, ATRplus tries to adjust the energy accordingly. To avoid a measurement or a lock onto such a target, a spot analyser is needed to detect the reflections. The spot analyser evaluates the spot and decides if it is a real prism spot or another reflection. If it detects a non-prism spot during a single measurement, it stops the measurement and shows a message. When searching for a prism using the fine search window, each spot is analysed. If a non-prism reflection is detected, the search is continued with reduced energy. Subsequently such reflections will no longer appear as spots on the CMOS.

The spot analyser of ATRplus can detect reflective objects like safety vests or road signs as non-targets.

Detection of Foreign Reflections

Sun reflections from reflective surfaces such as cars, road signs, windows, water, and bright light sources like car headlights can be visible on the CMOS sensor (Figure 2).



Figure 2 - Images from the CMOS sensor. Left: prism spot. Right: two car headlights and sun reflections on the car.

Such reflections and lights could appear similar to a prism spot and must therefore be identified. When locking on a moving prism, such reflections or lights could suddenly appear on the CMOS sensor. In addition, when the prism disappears for a short moment behind an obstruction, foreign reflections could be the only visible spots on the CMOS sensor. Therefore, it is important to recognise such reflections to avoid a measurement or a lock-in on them.

ATRplus uses a combination of dark, gray, and bright images for the reliable detection of foreign reflections.

To detect foreign reflections, ATR detected “dark images” without emitting a laser beam. In these images, only foreign reflections are visible. However, since the prism spot is not visible, this image cannot be used for a measurement and does not help to lock onto a prism. When the prism is close to the instrument, the relative speed of the prism to the instrument can be high. Thus, every single image is important if ATR is not going to lose the prism. However, it had to identify foreign reflections as fast as possible. To fulfil both requirements, a fast detection of foreign reflections and a position for the prism in every image, ATRplus uses a so called “grey image” for every second image. Here the laser power is only partially reduced. Since the integration time of the CMOS sensor is kept constant, foreign reflections appear in every image with the same brightness. The prism spot instead is alternately bright or grey, and can therefore be differentiated from the foreign reflections. To keep the quality of the measurements high, only the deviations derived from bright images are stored. ATRplus only uses the grey images internally to follow the prism.

Compared to ATR, the new concept used for ATRplus is much more robust against foreign reflections and bright lights. Figure 3 shows the

view through the telescope during a long-range test (approximately 1000 m) of ATRplus.



Figure 3 - ATRplus (left) is correctly locked onto the prism on the top of the car. ATR (right) tries to lock onto the car headlights.

History Logs

Spots detected on the CMOS sensor and identified as non-prism spots are stored as a history during the next few frames. If a second prism appears in the field of view of ATRplus, this spot is also recognised as another prism. Thus, all targets in the field of view of the telescope are identified, labelled with an internal temporary ID, and stored in the history. If the prism marked as the prism in use suddenly disappears, the instrument turns into prediction mode and will not lock onto the second prism, because this is known in the history as an irrelevant prism. The history stores the following:

- Prism spot (location and brightness)
- Foreign reflections (number, location, and brightness)
- Foreign prisms (number, location, and brightness)

The history prevents a lock-in on a foreign prism or reflection after a loss of lock. The history is valid until the end of the prediction and helps decide whether it is the prism. Figure 4 shows a situation where the locked prism disappears behind the tree. There is another prism in front of the tree. Nevertheless, the instrument does not lock onto the forward prism because it had been identified beforehand.

ATRplus history logs help to prevent locking onto the wrong prism. The past information is used to predict the future.



Figure 4 - Left: test setup with two prisms (360° prism GRZ122 and round prism GPR121) in the field of view of the instrument. Right: visualisation of the two spots as ATRplus sees them.

Performance

High automation performance of the total stations and MultiStations are required in kinematic measurement applications. Fast and reliable automated target aiming and following of a prism is crucial. Therefore, ATRplus, the motorisation of the instrument, the PowerSearch functionality, intelligent algorithms, processor power, and measurement synchronisation are important elements of high performance total stations and MultiStations.

When measuring dynamic objects such as construction machines or robotic surveying applications, surveying instruments have to cope with difficult tasks (see Figure 5). Varying environmental situations as well as unexpected changes of the moving direction of the observed object have to be considered.



Figure 5 - Test scenario with possible negative influences on the performance of following a prism (rain, bright lights, and various targets).

Together with the improved performance in all possible conditions, the handling of the instruments is simplified because of fewer user settings. Therefore, the benefits of ATRplus are noticeable for the user in ease of use and the ability to cope with complex measurement conditions.

Minimal User Settings

Because ATRplus automatically and continuously adjusts laser energy based on distance and environmental conditions, the need for user interaction is reduced to a minimum. Instrument settings regarding the environmental conditions (e.g. rain and fog) and specific settings for the expected object movement (e.g. the setting “high dynamics at short range”) are set automatically by the instrument. ATRplus does not require former settings concerning the visibility (see Figure 6 left). It only needs the prism type, the aiming option, and the distance measurement type (see Figure 6 right) for reliable and accurate measurements.

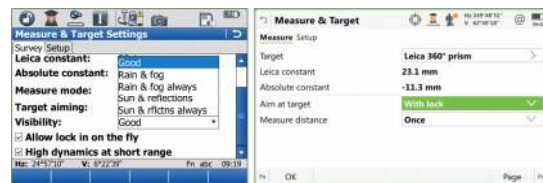

Figure 6 - Overview of the manual settings in SmartWorx Viva with ATR (left) and Leica Captivate with ATRplus (right).

Dynamic energy control, spot analysis, and tight measurement synchronisation enable automatic parameter selection.

The dynamic energy control, automatic regulation of the motor controller, and better measurement synchronisation are crucial implementations for the simplification of the user handling. Table 1 compares the user settings in SmartWorx Viva with ATR to the Leica Captivate with ATRplus.

Table 1 - Comparison of the different settings in SmartWorx Viva with ATR and in Leica Captivate with ATRplus.

	SmartWorx Viva	Leica Captivate
Visibility (environmental condition)	<ul style="list-style-type: none"> Good Rain & Fog Sun & Reflection 	<ul style="list-style-type: none"> No settings needed
Range information	<ul style="list-style-type: none"> High dynamics at short range 	<ul style="list-style-type: none"> No settings needed
Distance measurement mode	<ul style="list-style-type: none"> Continuous Continuous+ 	<ul style="list-style-type: none"> Continuously
Dynamic information	<ul style="list-style-type: none"> Allow to lock in on the fly 	<ul style="list-style-type: none"> Wait & lock directly accessible

Automated Aiming Range

Beside the reduction of the manual user settings, the continuous energy control allows extension of the range of the automatic target aiming (static) and locking (dynamic). Depending on the target type, the instruments can reach automated aiming ranges of up to 1500 m (see Figure 7).



Figure 7 - Achievable ranges¹ for automated target aiming (static).

ATRplus enables an automated target aiming range extension of more than 50% on the round prism (GPR121) compared to ATR. Figure 8 shows the extended automated aiming range comparing ATR (with TS15/TS50/MS50) with ATRplus (with TS16/TS60/MS60).

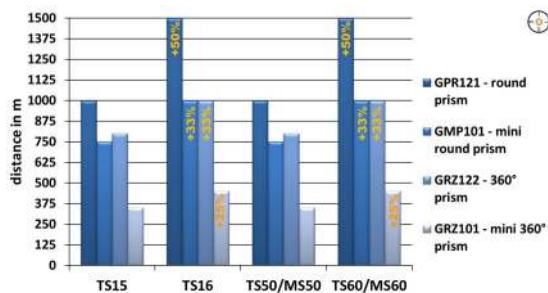

Figure 8 - Automated target aiming ranges for different prism types (ATRplus versus ATR).

Although the automated target aiming range specifications relate to ideal environmental conditions, the possible achievable ranges under difficult conditions such as rain, heat shimmer, and dust have been extended in similar relations with ATRplus. For kinematic applications, the ranges for following a prism extend to 1000 m.

Locking Range

ATRplus enables measurements of fast moving prisms. A prism that passes by the instrument with a lateral distance of 10 m can be followed up to a speed of 80 km/h. Regarding distance measurement, a significant difference exists between the MultiStation (MS) and the total station (TS) originated by the distance measure-

¹ Overcast, no haze, visibility about 40 km, no heat shimmer

ment technology. The PinPoint R2000 EDM of the MultiStation (Maar and Zogg, 2014) enables fast distance measurements, which results in the capability to measure prisms with a radial speed of 50 km/h and more, while the speed limit for the PinPoint R1000 is 20 km/h (see Figure 9).



Figure 9 - Achievable ranges¹ and velocities² in Lock-mode.

Figure 10 shows the improved lock and tracking performance of ATRplus. The figure shows the measurement performance of following and measuring on a 360° degree prism (GRZ122) with ATR and ATRplus. The measurements with ATRplus show more data points and fewer interruptions than with ATR.

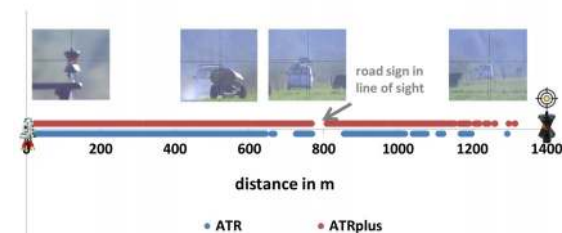

Figure 10 - Following and measuring on a prism under sunny conditions.

Besides the stable following of a prism at higher ranges, ATRplus allows the instrument to “re-lock” faster on a temporary lost prism. Furthermore, it is also robust against foreign reflections. The longer ranges, the enlarged stability, and robustness give ATRplus an advantage in following dynamic targets under rainy conditions, Figure 11 for instance illustrates the stable lock and longer range of ATRplus under difficult conditions.

² Tangential movement, 15 m to the instrument

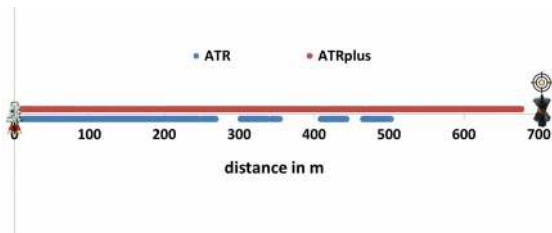

Figure 11 - Following and measuring onto a prism under difficult (rainy) conditions.

The target aiming and locking performance of ATRplus enables more flexibility to full-fill individual needs in the field.

Measurement Accuracy for Automated Target Aiming

ATRplus enables automated target aiming with the highest angular accuracy. For the Leica Nova TS60 – the highest accurate total station – ATRplus achieves 0.5" angular accuracy tested according to ISO 17123-3 for automated target aiming.

Table 2 - Automatic target aiming accuracy of ATRplus tested according to ISO 17123-3 for the latest generation of Leica Nova and Leica Viva total stations and MultiStation.

	Specification ³
Leica Viva TS16	1" (0.3 mgon), 2" (0.6 mgon), 3" (1 mgon), 5" (1.5 mgon)
Leica Nova TS60	0.5" (0.15 mgon)
Leica Nova MS60	1" (0.3 mgon)

Measurement Accuracy during Lock

A total station is a multi-sensor system. It needs a large number of different sensor observations to calculate the position of an observed target. Automation tasks such as precisely following and measuring a moving target require both highly sensitive and fast sensors and actuators. What is more, expertise is required to accurately evaluating the gathered data. The complex system requires a high temporal synchronisation of all used sensors to achieve the highest precision in following dynamic objects. Therefore, ATRplus has a goal of more accurate temporal synchronisation of various sensors for such factors as angles, distances, ATRplus measurements, and inclinations.

³ Overcast, no haze, visibility about 40 km, no heat shimmer

To obtain comparative values regarding the sensor synchronisation, the instruments track a 360° prism 30 times while the prism rotates on a vertical wheel with a diameter of approximately 1m (see Figure 12). This setup allows testing the synchronisation between the angle measurements, ATRplus measurements, and the tilt sensor.

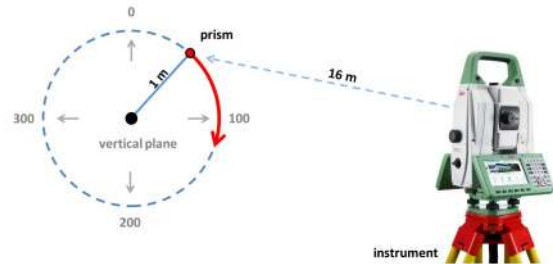

Figure 12 - Test setup to check the synchronisation of angle and ATRplus measurements (front view).

When following a moving prism on a wheel, the reverse points of the trajectory are the most critical for the instrument. These points are at the position of 100 gon and 300 gon for the horizontal angle (referring to the movement circle of the prism on the wheel) and at 0 gon and 200 gon for the vertical angle measurements.

Tight sensor synchronisation within the total station enables highly accurate measurements on dynamic prisms.

Figure 13 illustrates the results of ATR and ATRplus measurements. The figure shows the residuals between the measurements and the best fit ellipse. The ellipse has been calculated with a least-squares adjustment approach. The periodical behaviour of the residuals appears because the measurement synchronisation is still not 100% exact. Although the deviations of both types, ATR and ATRplus, are quite similar, the improved sensor synchronisation of the latest instrument generation is evident. A reduction of the measurement scattering, as well as less and smaller "outliers" at the reverse points, are obtainable.

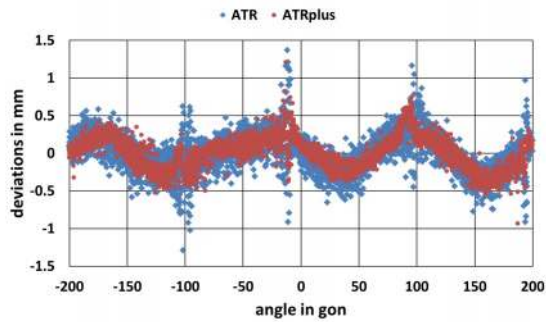

Figure 13 - Deviations of the measurement accuracy.

When the rotation wheel rotates in a horizontal plane (see Figure 14), it is possible to see the integration of the measured distances and their synchronisation with angles in ATRplus measurements and inclination measurements. Due to the larger distance changes, the difference in the time synchronisation can be seen as deviations of the measured trajectory on an ideal circle.

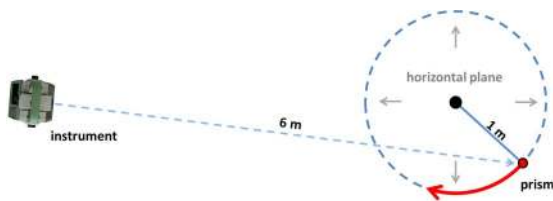

Figure 14 - Test setup to check the distance synchronisation (top view).

To calculate the deviations of the measurements to the true trajectory, a least-squares adjustment has been performed to fit a circle into the observed dataset (see Figure 15). Therefore, the orthogonal distances d_i (measurements - circle) have been calculated through the functional relation:

$$d_i = \sqrt{(m_1 - \xi_i)^2 + (m_2 - \eta_i)^2} - r$$

Where m_1 , m_2 are the midpoint of the circle, r is the radius, and ξ_i , and η_i are the 2D coordinates of the measurements.

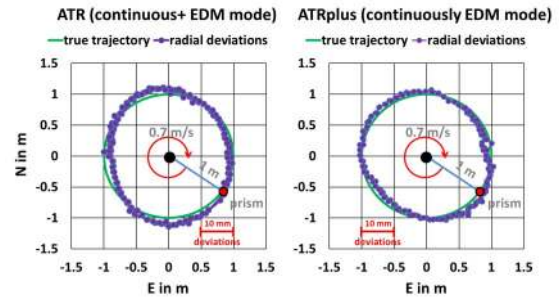

Figure 15 - Deviations of the measurements to the true trajectory.

The 90% quantile (see Table 3) of the radial deviations shows an improvement from ATR to ATRplus of about 20%.

Table 3 - 90% quantile of the radial deviations.

Technology	90% quantile
ATR	2.19 mm
ATRplus	1.75 mm

The numerical results in Table 3 refer to a Leica Viva TS15 (ATR) and Leica Viva TS16 (ATRplus) total station. The numerical values are for illustration purposes to show the effects of the improved temporal synchronisation in a practical situation. The values may vary depending on the measurement setup.

ATRplus reduces the gap of the measurement accuracy between the measurements on high-dynamic and static prisms.

PowerSearch

ATRplus deals with lock stability when the instrument is following a dynamic target. If the target is lost because of obstacles in the line of sight, for example, the instrument must be able to find the corresponding target again. The PowerSearch technology is an efficient way to find the target fast. After starting the PowerSearch "scan", the instrument detects possible prisms and aims at the first found target. In specific situations where more than one prism is visible (see Figure 16), the risk of aiming at the wrong one exists. To eliminate this situation, the so called "PowerSearch filter" and "CubeSearch" functionality have been introduced with the latest generation of total stations and MultiStations.



Figure 16 - Using the PowerSearch filter to eliminate non-relevant targets.

PowerSearch Filter

With the PowerSearch filter, the instrument creates a list of possible targets to be ignored in later PowerSearch searches. An exclusion region around the non-relevant target is defined by Hz, V, and distance, which are directly estimated from the PowerSearch module in the telescope. The PowerSearch module is capable of determining the Hz direction within about 0.2 gon (1σ) the distance within 1.5m (1σ). The exclusion areas are further defined in a range of +/- 1 gon in a horizontal direction and +/- 10 m in a radial direction (Grimm and Hornung, 2015). The vertical direction is limited to the PowerSearch laser fan (about 40 gon). If the PowerSearch filter is active, targets that fulfil all three criteria will be ignored in the PowerSearch search.

The PowerSearch filter can be learned either by scanning the surrounding area (Filter learn) or by adding the setup points during the setup. For adding the points during the setup, a distance measurement to the setup target is required. The PowerSearch filter can be accessed in Leica Captivate via the "Aim&Search" panel by pressing the top left icon (see Figure 17).



Figure 17 - Learning the PowerSearch filter via the "Aim & Search" panel.

"Filter learn" learns the PowerSearch filter. The telescope turns 3 times around its vertical axis - first in a horizontal position of the telescope, second with the telescope pointing to a higher

vertical position, and third with the telescope pointing to a lower vertical position. This procedure takes approximately 30 seconds.

The PowerSearch filter excludes non-relevant targets from further PowerSearch searches.

The PowerSearch filter can be switched off and on again by the user. This might be needed to find a reference target that has been included in the PowerSearch filter exclusion list.

CubeSearch

In combination with the PowerSearch filter, CubeSearch is a powerful way to relock onto the target after a losing the prism. After a certain target prediction time, the telescope turns 45° backwards from the position where the target was seen last. From that position, a PowerSearch is performed over 90°. If a valid distance of this last position is available, PowerSearch searches for the target only within a range of +/- 10 m (see Figure 18). Prisms and other non-relevant objects learned by the PowerSearch filter are ignored by the CubeSearch.

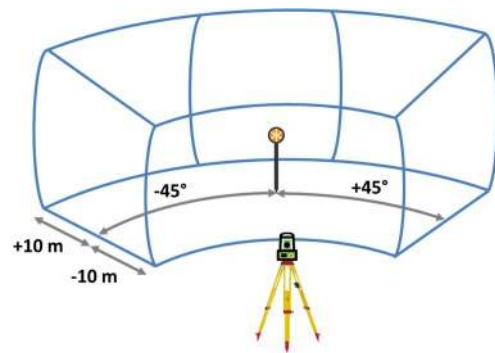

Figure 18 - CubeSearch with distance information.

If there is no valid distance information of the lost target is available, the instrument extends the "cube" in radial direction to the limits of the PowerSearch of 5 m – 300 m (see Figure 19).

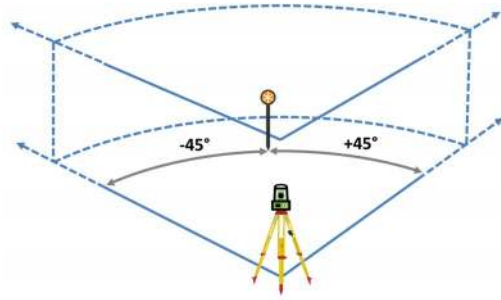

Figure 19 - CubeSearch without distance information.

Adding the distance information to the CubeSearch increases the reliability when re-locking a lost target.

Summary

Search, Lock and Re-Lock of a prism by a total station establishes the foundation of the automation cycle. When the instrument is locked on the prism, the distance can continuously be measured onto the prism and 3D positions of the prism are delivered. The measurement professional requires accurate 3D positions with a high update rate and high availability. ATRplus plays a dominant role in this automation cycle. High productivity strongly relates to the uptime of the instrument on the prism.

Dynamic energy control, history logs, intelligent algorithms for spot verification, target search, and tighter sensor synchronisation are the main characteristics of the automation performance with ATRplus. The integration of ATRplus technology is a crucial factor in making the latest generation of total stations and MultiStations more intelligent and bringing automation performance to the next level.

Using ATRplus technology reduces possible error sources such as wrong user settings and expands the boundaries of automated surveying in terms of range and dynamics. ATRplus technology in combination with the PowerSearch filter and CubeSearch functionality accelerates the measurement performance on static and dynamic targets.

References

Grimm, D. E. and Hornung, U. (2015). Leica ATRplus - Leistungssteigerung der automatischen Messung und Verfolgung von Prismen. AVN, pages 269–276.

Maar, H. and Zogg, H.-M. (2014). WFD – Wave Form Digitizer Technology. Technical report, Leica Geosystems AG.

Stempfhuber, W. and Kirschner, H. (2008). Kinematische Leistungsfähigkeit von zielverfolgenden Tachymetern – Ein Beitrag zum Stand der Technik am Beispiel des Leica TPS1200+. AVN, pages 216–224.

Leica Geosystems - when it has to be right.

Revolutionising the world of measurement and survey for nearly 200 years, Leica Geosystems creates complete solutions for professionals across the planet. Known for valuable products and innovative solution development, professionals in a diverse mix of industries, such as aerospace and defence, safety and security, construction, and manufacturing, trust Leica Geosystems for all their geospatial needs. With precise and accurate instruments, sophisticated software, and dependable services, Leica Geosystems delivers value every day to those shaping the future of our world.

Leica Geosystems is part of Hexagon (Nasdaq Stockholm: HEXA B; hexagon.com), a leading global provider of information technologies that drive quality and productivity improvements across geospatial and industrial enterprise applications.



Illustrations, descriptions and technical data are not binding. All rights reserved.
Printed in Switzerland - Copyright Leica Geosystems AG, Heerbrugg, Switzerland, 2015.
10.15 - INT



Leica Nova MS60



Leica Viva TS16



Leica Viva GS15



Leica Infinity



A TRADITION IN PRECISION

Seattle 425-771-7776 | Tacoma 253-922-6087
Portland 503-641-3388 | Salt Lake City 801-878-9763
St. George 801-878-9763 | Las Vegas 702-586-1152
www.krinc.net