

Multi-Channel IN-OUT Thermometer with Cable Free Sensor and RF Clock

MODEL: RMR112

USER'S MANUAL

INTRODUCTION

Congratulations on your purchase of the RMR112 Multi-Channel In-Out Thermometer with 433MHz cable free sensor and radio-controlled calendar clock.

The basic package comes with a main unit, which is the temperature and calendar clock station, and a remote unit, the thermo sensor.

The main unit has large read-outs for indoors temperature, calendar clock and temperatures collected and transmitted by the remote unit. The main unit can support up to three remote units.

The main unit is capable of keeping track of the maximum and minimum temperature of different sites. And no wire installation is required and the RMR112 operates at 433MHz.

As for the calendar clock, it is radio-controlled. It automatically synchronizes its current time and date when it is brought within an approximate 1500km radius of the radio signal generated from Frankfurt, Germany (DCF77).

You can also set the calendar clock manually when it is off range. Other features include four-language display, four-step crescendo dual alarms and interchangeable display modes.

MAIN FEATURES

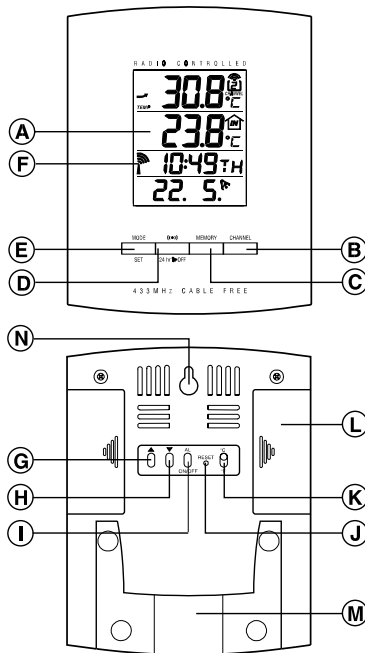

A FOUR-LINE DISPLAY

Facilitates easy reading of remote and indoors temperatures and calendar clock

B CHANNEL BUTTON

Selects among different channels

C MEMORY BUTTON

Recalls the maximum or minimum temperature of individual channels

D ALARM [24HR OFF] BUTTON

Sets the time for the alarms

E MODE/SET BUTTON

Toggles the display modes and confirms entry while setting the values for display

F RADIO RECEPTION SIGNAL

Indicates the condition of radio reception

G UP (▲) BUTTON

Advances the value of a setting

H DOWN (▼) BUTTON

Decreases the value of a setting

I ALARM [AL ON/OFF] BUTTON

Enables or disables the alarms

J RESET BUTTON

Returns all settings to default values

K °C/°F SLIDE SWITCH

Selects between degree Centigrade (°C) and Fahrenheit (°F)

L BATTERY COMPARTMENTS

Accommodates two UM-3 or “AA” size 1.5V alkaline batteries

M REMOVABLE TABLE STAND

For standing the main unit on a flat surface

N WALL-MOUNT RECESSED HOLE

For mounting the main unit on a wall

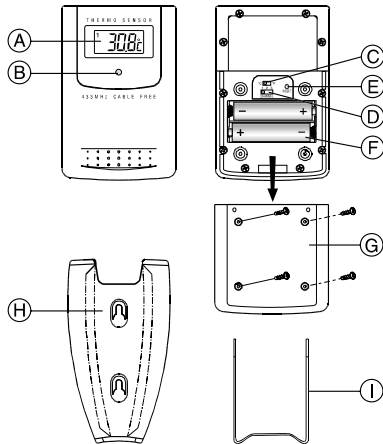
MAIN FEATURES: REMOTE UNIT

- (A) LCD**
Displays the current temperature monitored by the remote unit
- (B) LED INDICATOR**
Flashes when the remote unit transmits a reading
- (C) °C/°F SLIDE SWITCH**
Selects between Centigrade (°C) and Fahrenheit (°F)
- (D) CHANNEL SLIDE SWITCH**
Designates the remote unit Channel 1, Channel 2 or Channel 3
- (E) RESET BUTTON**
Returns all settings to default values
- (F) BATTERY COMPARTMENT**
Accommodates two AAA-size batteries
- (G) BATTERY DOOR**
- (H) WALL-MOUNT HOLDER**
Supports the remote until in wall-mounting
- (I) MOVABLE TABLE STAND**
For standing the remote unit on a flat surface

BEFORE YOU BEGIN

For best operation,

1. Assign different channels to different remote units.
2. Insert batteries for remote units before doing so for the main unit.
3. Place the main unit as close as possible next to the remote unit,

reset the main unit after installing batteries. This will ensure easier synchronization between the transmission and reception of signals.

4. Position the remote unit and main unit within effective transmission range, which, in usual circumstances, is 20 to 30 meters.

Note that the effective range is vastly affected by the building materials and where the main and remote units are positioned. Try various set-ups for best result.

Though the remote units are weather proof, they should be placed away from direct sunlight, rain or snow.

BATTERY AND CHANNEL INSTALLATION: REMOTE UNIT

1. Remove the screws on the battery compartment.
2. Select the channel number on the CHANNEL slide switch.
3. Select the temperature display unit on the C/F slide switch.

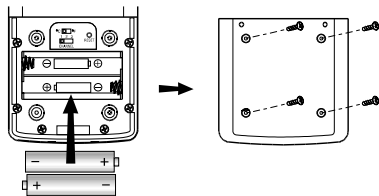

4. Install 2 alkaline batteries (UM-4 or “AAA” size 1.5V) strictly according to the polarities shown.
5. Replace the battery compartment door and secure its screws.

Note that once a channel is assigned to a remote unit, you can only change it by removing the batteries or resetting the unit.

BATTERY INSTALLATION: MAIN UNIT

1. Slide open the battery compartment door.
2. Install 2 alkaline batteries (UM-3 or “AA” size 1.5V) strictly according to the polarities shown.

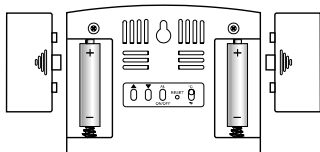

3. Replace the battery compartment door.

LOW BATTERY WARNING

When it is time to replace batteries, the respective low-battery indicator will show up when the respective channel is selected. The battery level of the main unit will be shown on the indoor temperature when it is running low.

HOW TO USE THE TABLE STAND OR WALL MOUNTING

The main unit has a removable table stand, which when connected, can support the unit on a flat surface. Or you can remove the stand and mount the unit on a wall using the recessed screw hole.

As for the remote unit, it comes with a wall-mount holder and a removable stand. Use either to hold the unit in place.

Main unit

Wall-mount

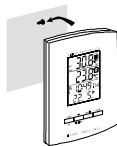
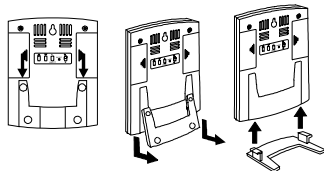

Table Stand



Wall-mount

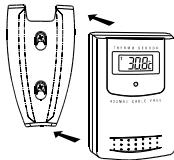
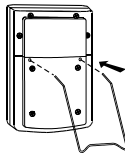

Table Stand



THE RESET BUTTON

This button is only used when the unit is operating in an unfavorable way or malfunctioning. Use a blunt stylus to hold down the button. All settings will return to their default values.

GETTING STARTED

Once batteries are in place for the remote units, they will start transmitting temperature readings at 30-second intervals.

The main unit will also start searching for signals for about a minute once batteries are installed. Upon successful reception, the individual channel temperatures will be displayed on the top line and the indoors temperature on the bottom line. The main unit will automatically update its readings at about 30-second intervals.



If no signals are received, blanks "----" will be displayed and the kinetic wave icon will show " [] ". Press CHANNEL and MEMORY simultaneously to enforce another search for about 30 seconds. This is useful in synchronizing the transmission and reception of the remote and main units.

Repeat this step whenever you find discrepancies between the reading shown on the main unit and that on the respective remote unit.

HOW TO CHECK REMOTE AND INDOOR TEMPERATURES

The indoors temperature is shown on the second line of the display.

As for the remote sites or channels, press CHANNEL to go from one channel to another. The kinetic wave display on the channel number indicates the reception of that particular channel is in good order.

If no readings are received from one particular channel for more than two minutes, blanks "----" will be displayed until further readings are successfully searched. Check the remote unit is sound and secure. You can wait for a little while or press CHANNEL and MEMORY simultaneously to enforce an immediate search. Of course no reading will be shown if no remote unit is assigned to that channel.

If the temperature goes above or below than the temperature measuring range of the main unit or the remote unit (stated in specification), the display will show "HHH" or "LLL".





TEMPERATURE TREND

The temperature trend indicator on the screen shows the trend of samplings collected at that particular remote site. Three trends, rising, steady and falling, will be shown.

Arrow indicator	 TREND	 TREND	 TREND
Temperature Trend	Rising	Steady	Falling

HOW TO READ THE KINETIC WAVE DISPLAY

The kinetic wave display shows the signal receiving status of the main unit. There are three possible forms:

The unit is in searching mode.	• 
Temperature readings are securely registered.	•   
No signals.	•

MAXIMUM AND MINIMUM TEMPERATURES

The maximum and minimum recorded indoor temperatures and those of each channel will be automatically stored in memory. To display them,

1. Select the channel to be checked.
2. Press **MEMORY** once to display the maximum temperature and again the minimum temperature. The respective indicators, **MAX** or **MIN** will be displayed.

To clear the memory, hold down **MEMORY** for two seconds. The maximum and minimum temperatures will be erased. If you press **MEMORY** now, the maximum and minimum temperatures will have the same values as the current ones until different readings are recorded.

DISCONNECTED SIGNALS

If without obvious reasons the display for a particular channel goes blank, press **CHANNEL** and **MEMORY** to enforce an immediate search. If that fails, check:

1. The remote unit of that channel is still in place.
2. The batteries of both the remote unit and main unit. Replace as necessary.

Note: When the temperature falls below freezing point, the batteries of outdoor units will freeze, lowering their voltage supply and the effective range.

3. The transmission is within range and path is clear of obstacles and interference. Shorten the distance when necessary.

TRANSMISSION COLLISION

Signals from other household devices, such as door bells, home security systems and entry controls, may interfere with those of this product and cause temporarily reception failure. This is normal and does not affect the general performance of the product. The transmission and reception of temperature readings will resume once the interference recedes.

NOTE ON °C AND °F

The unit of temperature display is selected on the °C/°F slide switch. Select °C for Centigrade or °F for Fahrenheit.

Note that the remote temperature display on the main unit is dominated by the selection on the °C/°F slide switch of the main unit. Whatever the display units of the remote sensors are, they will be

automatically converted to the chosen one of the main unit.

CALENDAR CLOCK DISPLAY MODES

The RMR112 supports four display modes in the sequence of:

MODE 1. Hour-Minute-Second (of local time)

Day-Month (of local time)

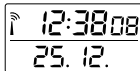

MODE 2. Hour-Minute-Day of the Week (of local time)

Day-Month (of local time)

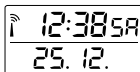

MODE 3. Hour-Minute-Day of the Week (of local time)

Hour-Minute (of second time zone)

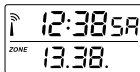

MODE 4. Hour-Minute-Day of the Week (of second time zone)

Day-Month (of second time zone)

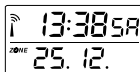

Each press on the MODE button will toggle the display in the above order.

Note: The bottom line of the display will be replaced by the alarm time if the [24HR OFF] button is pressed.





ABOUT RADIO RECEPTION

The RMR112 is designed to automatically synchronize its calendar clock once it is brought within range of the Frankfurt DCF77 radio signal.

When the RMR112 is within range, its radio-control mechanism will override all manual settings.

When the unit is receiving radio signal, the radio reception signal will start to blink. A complete reception generally takes about 2 to 10 minutes, depending on the strength of the radio signal.

When the reception is complete, the radio reception signal will stop blinking. The strength of the reception for the last full hour will be indicated.

	- Strong
	- Weak
	- No Reception
	- Receiving

For better reception, place the clock away from metal objects and electrical appliances to minimize interference.

If you wish to disable the auto-reception feature, press the ▼ button for three seconds. The radio reception signal will disappear. The unit will not respond to radio signals.

To enable the feature again, press the ▲ button for three seconds. The radio reception signal will start blinking to initiate reception automatically.

HOW TO SET THE CLOCK MANUALLY

To set the clock manually, hold **MODE/SET** for three seconds. The display will return to MODE 1, with the hour digits blinking.

Use ▲ or ▼ to select the hour. Keep pressing the button will increase or decrease the value rapidly.

Press **MODE/SET** to confirm. The minute digits will blink. Repeat the same procedure to set the minutes, then the day-of-month, month, display language, day-of-week and offset for the second time zone.

Note that the time and date are displayed in 24-HOUR clock and DAY-MONTH format, respectively. For display language, you can choose among English (E), German (D), French (F) and Italian (I)-in that order. Day-of-week is the usual sequence of Monday through Sunday.

For the second time zone, which is indicated by the ZONE ICON, enter the hour offset using the ▲ or ▼ buttons and the RMR212 will calculate the second time accordingly.



If there is an item you do not wish to change, simply press **MODE/SET** to bypass the item.





When you are done, press **MODE/SET** to exit. The display will return to the mode last chosen.

HOW TO SET AND ARM THE ALARMS

The RMR112 has two alarms, ALARM 1 and ALARM 2. They can be invoked together or independently.

To set an alarm,

1. Press [24HR  OFF] once to select ALARM 1 or again to select ALARM 2. The last selected time of the alarm will be displayed. If you have never set the alarm before, the time will be displayed as 0:00.
2. Press [24HR  OFF] for three seconds. The hour digits will blink.
3. Enter the hour using ▲ or ▼.

4. Press [24HR  OFF]. The minute digits will blink.
5. Enter the minutes using  or .
6. Press [24HR  OFF] to exit.

The alarm ON icon for the alarm chosen will be displayed indicating the alarm set above is now armed.

You can also arm or disarm an alarm by pressing the AL ON/OFF button.

HOW TO STOP AN ALARM

To stop an alarm, you can use either [24HR  OFF] or AL ON/OFF.

Pressing [24HR  OFF] will stop the alarm, which is still armed and will go off at the set time the following day.

If AL ON/OFF is pressed instead, the alarm will be stopped and deactivated all together.

PRECAUTIONS

This product is engineered to give you years of satisfactory service if you handle it carefully. Here are a few precautions:

1. Do not immerse the unit in water.
2. Do not clean the unit with abrasive or corrosive materials. They may scratch the plastic parts and corrode the electronic circuit.
3. Do not subject the unit to excessive force, shock, dust,

temperature or humidity, which may result in malfunction, shorter electronic life span, damaged battery and distorted parts.

4. Do not tamper with the unit's internal components. Doing so will invalidate the warranty on the unit and may cause unnecessary damage. The unit contains no user-serviceable parts.
5. Only use fresh batteries as specified in the user's manual. Do not mix new and old batteries as the old ones may leak.
6. Always read the user's manual thoroughly before operating the unit.

TIME ZONE AND OFFSET TABLE

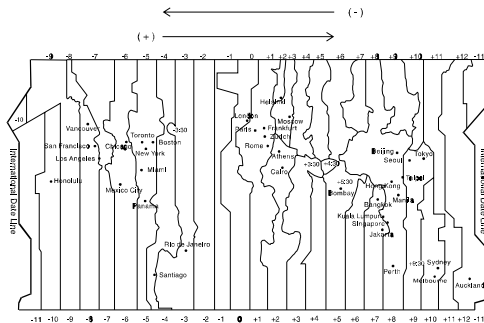

SPECIFICATIONS

Temperature Measurement

Main unit

Indoor Temperature measurement

Proposed operating range	: -5.0°C to +50.0°C 23.0°F to 122.0°F
Temperature resolution	: 0.1°C 0.2°F

Remote Temperature measurement

Proposed operating range	: -5.0°C to +50.0°C 23.0°F to 122.0°F
Temperature resolution	: 0.1°C 0.2°F

Remote unit

Proposed operating range	: -20.0°C to +60.0°C -4.0°F to 140.0°F
Temperature resolution	: 0.1°C 0.2°F
RF Transmission Frequency	: 433 MHz
No. of Remote unit	: Maximum of 3
RF Transmission Range	: Maximum 30 meters
Temperature sensing cycle	: around 30 seconds

Radio Controlled Clock

Maintime set and synchronized by Radio Signal DCF77 for Continental/ Central Europe
 24 h display with hh : mm ss
 Date Format : Day. Month.
 Day of week selectable in 4 language (E, F, D, I)
 Second time zone with date and day
 2-minute crescendo alarm

Power

Main unit	: use 2 pcs UM-3 or "AA" 1.5V alkaline battery
Remote sensing unit	: use 2 pcs UM-4 or "AAA" 1.5V alkaline bat tery

Weight

Main unit	: 190 gm
Remote sensing unit	: 100 gm

Dimension

Main unit	: 136(L) x 108(W) x 27(T) mm
Remote sensing unit	: 92(L) x 60(W) x 21(T) mm

NOTE ON COMPLIANCE

Warning: Changes or modifications to this unit not expressly approved by the party responsible for compliance could void the user's authority to operate the equipment.

R&TTE Compliance Note

This device complies with the essential requirements of Article 3 of the R&TTE 1999/5/EC Directive, if used for its intended use and that the following standard(s) has been applied:

Electromagnetic compatibility (Article 3.1.b of the R&TTE Directive)

Applied standards ETS 300 683 : 1997

Efficient use of the radio frequency spectrum (Article 3.2 of the R&TTE Directive)

Applied standards EN300 220 -1 : 1997

CAUTION

- The content of this manual is subject to change without further notice.
- Due to printing limitation, the displays shown in this manual may differ from the actual display.
- The contents of this manual may not be reproduced without the permission of the manufacturer.