

Radio Controlled Kids Projection Clock with Nightlight

MODEL: RM813PA

Instruction Manual

INTRODUCTION





Congratulations on your purchase of the RF Projection Clock RM813PA.

The RM813PA is a multifunctional radio-controlled clock. It can automatically synchronize its current time and date when brought within range of the U.S. Atomic Clock.

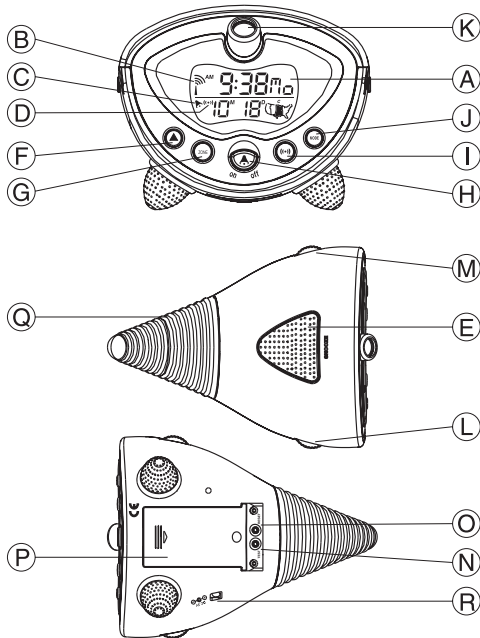
The unit comes with a projector that in the dark can project large, clear clock-time digits onto the flat surfaces. It also has a nightlight at the back of the unit.

MAIN FEATURES



- A Two-line display**
Displays the current time and calendar or alarm time
- B [] Radio reception signal**
Indicates the condition of radio reception
- C [] Alarm icon**
Appears when alarm is activated
- D [(••)] Alarm icon**
Appears when alarm time is displayed
- E [SNOOZE] button**
Enables the snooze function when the alarm goes off or activates the projector for five seconds
- F Up [▲] button**
Increases or decreases the value of a setting
- G [ZONE] button**
Press to toggle among the 4 U.S. time-zones: Pacific (P), Mountain (M), Central (C) or Eastern (E)
- H [ ON/OFF] button**
Press to turn on or off the alarm
- I [(••)] button**
Sets the time for the alarm
- J [MODE] button**
Toggles the display modes and confirms entry in clock setting mode
- K Projector**
For projecting the current time on the wall or ceiling
- L [ PROJECTION ON] switch**
Used with the power adapter to enable extended use of the projector

- M [LIGHT ON ] switch**
Used with power adapter to enable extended use of the guiding light
- N [TEST] button**
Turn on the nightlight as long as it is pressed and held
- O [RESET] button**
Resets the unit by returning all settings to factory default values
- P Battery compartment**
Accommodates two (2) UM-3 or “AA” size batteries
- Q Night light**
- R AC adapter jack**

BATTERY INSTALLATION

The unit uses two (2) UM-3 or “AA” size 1.5V batteries.

To insert batteries:

1. Slide the battery door in the direction of the arrow.
2. Insert the batteries according to the polarities shown therein.
3. Replace the battery compartment door.
4. Press the [RESET] button.

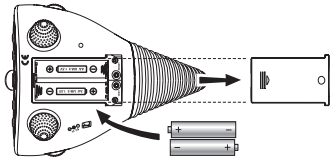

When the low battery indicator [] is shown on the display, replace with fresh batteries.

Note: Under normal circumstances, the batteries are good for 1 year. However, the battery life can be reduced vastly by frequent use of the projector or snooze function.



If not disposed of properly batteries can be harmful. Protect the environment by taking exhausted batteries to authorized disposal stations.

MOMENTARY PROJECTION FEATURE

Press [**SNOOZE**] and the projection will be activated for approximately 5 seconds.

Note: Make sure the [ PROJECTION ON] switch is switched to the front i.e. it is in the “Off” position.

CONTINUOUS PROJECTION FEATURE WITH POWER ADAPTER

RM813PA comes with an AC power adapter. Use of the AC power adapter is required for continuous time projection.

To install the adapter:

1. Insert adapter into the jack at the bottom of the unit.
2. Plug the adapter into an electrical wall outlet.

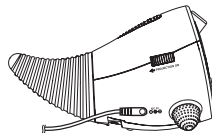

Note: Make sure the voltage is correct.

Once the power adapter is in place, you can select to turn on the projector for longer time (such as throughout the night) by sliding the [ PROJECTION ON] switch (located on the side of the unit) to the back i.e. it is in the “On” position. To turn off the projector, slide the switch to the front to the “Off” position.

*Note that this switch can only be used with the power adapter. For momentary projection, use the [**SNOOZE**].*





ABOUT RADIO RECEPTION

RM813PA is designed to synchronize its calendar clock automatically once it is brought within range of the U.S. Atomic Clock. When the unit is new and just out of the box, synchronization with the U.S. atomic clock can take up to 72 hours. The unit will receive the most dependable and interference free signal automatically between Midnight and 4 AM.

When the unit is receiving signal, the Radio Reception symbol [] will start to blink. Generally, complete reception takes around 2 to 10 minutes depending on the strength of the radio signal.

To disable the reception of RF signal manually, press and hold the [**ZONE**] button for 3 seconds until the Radio Reception symbol and the US-map outline disappear.

To enable the reception again, press and hold the [**▲**] button for 3 seconds. The Radio Reception symbol and the US-map outline will blink and the unit will search for RF signal automatically.

	STRONG
	WEAK
	NORECEPTION
	RECEIVING

Interference

Reception can be affected by a number of factors. For best reception, place the device away from metal objects and electrical appliances. Other causes for signal interference include electrical power transmission towers, steel reinforced concrete construction, and/or metal siding.

When the icon [] appears on the display, re-locate the unit to enhance better reception of radio signal.

***Note:** Radio Frequency appliances such as the Projection Alarm Clock perform best when placed near a window. After receiving the initial signal, updates are accomplished with greater ease. Even though there are areas that may have more difficulty in receiving a signal, the Projection Alarm Clock contains very accurate quartz movement and will retain precise time even if a signal is missed on a rare occasion.*

HOW TO SET THE CLOCK AND CALENDAR MANUALLY

To set the clock and calendar:

1. Press and hold [**MODE**] for 2 seconds and the hour digits will flash.
2. Enter the value by [**▲**] button.
3. Confirm the entry by pressing [**MODE**] and the minutes digits will flash.
4. Repeat (2) and confirm the entry by pressing [**MODE**].
5. Repeat the above steps to set the year, month, day and language

for day-of-week. For the day of the week language you can select among English (E), French (F) or Spanish (S).

Language	Day-of-the-week						
	Monday	Tuesday	Wed.	Thursday	Friday	Saturday	Sunday
English	Mo	Tu	We	Th	Fr	Sa	Su
French	L	MA	M	J	V	SA	Do
Spanish	L	MA	ME	JE	VE	SA	DI

To toggle among the 4 U.S. time-zones, press [ZONE] button to display Pacific, Mountain, Central or Eastern.

HOW TO SET THE ALARM

This unit is equipped with a daily alarm.

To set and activate the alarm:

1. Display the alarm time by pressing [(••)].
2. Press and hold [(••)] for 2 seconds. The hours digits will flash.
3. Enter the values by [▲] buttons.
4. Confirm the entry by pressing [(••)].
5. The minutes digits will flash.
6. Repeat (3) and (4) to finish the setting. The alarm will be activated automatically.

To deactivate the alarm:

1. Press [🛑 ON/OFF] to deactivate the Alarm. [🛑] will disappear when the alarm is being deactivated.
2. Press [🛑 ON/OFF] to activate the alarm again.

CRESCENDO ALARM AND SNOOZE FUNCTION

When the alarm goes off at the preset time, the projection will be turned on for 8 seconds. The [🛑] icon will be flashing and the alarm sound will be turned on.

The crescendo alarm function allows the alarm sound to start off gently with step-up intensity. Without interruption, the alarm will be on for 2 minutes.

To stop the alarm, press [(••)], [🛑 ON/OFF] or [SNOOZE]. If [🛑 ON/OFF] is pressed, the alarm will be turned off permanently. If [(••)] is pressed, the alarm will be turned off and be activated again after 24-hours. If [SNOOZE] button is pressed, the alarm sound will be turned off temporarily and the snooze function will be activated. The alarm will go off again after approx. 8 minutes until other key is pressed to turn off the alarm.

RESETTING THE UNIT

In case of malfunction or abnormal display, press the [RESET] button at the bottom of the unit with a blunt stylus. All settings will be cleared and reset to their default values.

HOW TO USE THE NIGHTLIGHT

RM813PA is equipped with a nightlight. To turn on the nightlight temporarily for testing its functionality, press the **[TEST]** button with a blunt stylus at the bottom of the unit. The light will be on as long as the button is pressed and held.

For continuous use of the nightlight, AC Power adapter is required to be connected. For instructions on how to install the adapter, please see Section “Continuous Projection feature with Power Adaptor.”

Once the power adapter is in place, slide the **[LIGHT ON ➔]** switch (located at the side of the unit) to the back i.e. the “On” position. The nightlight will be turned on for a longer time. To turn the light off, simply slide the switch in the opposite direction.

Note that this switch can only be used when the power adapter is installed. For turning the light on momentarily, use the **[TEST]** instead.

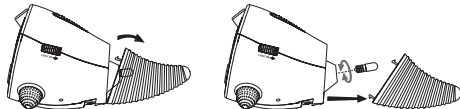

3. Then, remove the lightbulb by rotating it in a anti-clockwise direction.
4. Replace with new light bulb with correct specifications. Make sure the light bulb is securely fixed.
5. Replace the tail of the unit as shown.

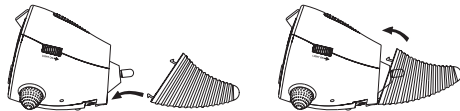

6. To test if the guiding light is working properly, install batteries into the battery compartment and press the **[TEST]** button. The light should be turned on as long as the button is held.
7. If the light does not turn on, check if the lightbulb is broken or if the lightbulb is well-connected to the unit.

HOW TO CHANGE THE GUIDING LIGHT BULB

RM813PA is pre-installed with a 3V lightbulb. In case you want to change the lightbulb follow the instructions below:

1. Un-install the power adapter from the unit to prevent electric shock. Also, remove the batteries from the battery compartment.
2. Remove the tail of the unit as shown.

MAINTENANCE

When handled properly, this unit is engineered to give you years of satisfactory service. Here are a few product care instructions:

1. Do not immerse the unit in water. If the unit comes in contact with water, dry it immediately with a soft lint-free cloth.
2. Do not clean the unit with abrasive or corrosive materials. Abrasive cleaning agents may scratch the plastic parts and corrode the electronic circuit.
3. Do not subject the unit to excessive: force, shock, dust, temperature, or humidity. Such treatment may result in malfunction, a shorter electronic life span, damaged batteries, or distorted parts.
4. Do not tamper with the unit's internal components. Doing so will terminate the unit's warranty and may cause damage. The unit contains no user-serviceable parts.
5. Only use new batteries as specified in this instruction manual.
6. Read this instruction manual thoroughly before operating the unit.

Battery Type	: Two (2) UM-3 or "AA" size 1.5V batteries
Unit Dimension	: 3.54 x 4.37 x 5.83 inches (H x W x D)
Unit Weight	: 7.05 ounces (without battery)
Lightbulb Rating	: 3V, 300 mA
Lightbulb Dimension	: T10 x 1.10 inches

PRODUCT SPECIFICATIONS

Operating Temperature	: +23°F to +122°F (-5°C to 50°C)
Radio Controlled	: Auto synchronizes current time and date by Radio signal generated from the U.S. Atomic Clock
Calendar	: Day of week in English / French / Spanish Current month / day format
Clock Time	: 12-hour format
Accuracy	: +/- 0.5 second/day (when RF is disabled)

CAUTION

- The content of this manual is subject to change without further notice.
- Due to printing limitation, the displays shown in this manual may differ from the actual display.
- The contents of this manual may not be reproduced without the permission of the manufacturer.

CUSTOMER ASSISTANCE

Should you require assistance regarding this product and its operation, please contact our customer care department at 800-853-8883 or via email at helpme@oscientific.com.

WARRANTY

This product is warranted to be free of manufacturing defects for a period of 90 days from date of retail purchase. Defective product should be directed to the place of retail purchase for exchange.

Should this not be possible, contact our customer care department for assistance and a return material authorization. No returns may be made without a return authorization. Please retain your retail receipt as you may be asked to provide a copy of it for proof of date purchased.

This warranty does not cover product subjected to abuse, misuse, accidental damage or tampering.