

CAUTION

- The content of this manual is subject to change without further notice.
- Due to printing limitation, the displays shown in this manual may differ from the actual display.
- The contents of this manual may not be reproduced without the permission of the manufacturer.

CUSTOMER ASSISTANCE

Should you require assistance regarding this product and its operation, please contact our customer care department at 800-853-8883 or via email at helpme@oscientific.com.

WARRANTY

This product is warranted to be free of manufacturing defects for a period of 1 year from date of retail purchase. Defective product should be directed to the place of retail purchase for exchange.

Should this not be possible, contact our customer care department for assistance and a return material authorization. No returns may be made without a return authorization. Please retain your retail receipt as you may be asked to provide a copy of it for proof of date purchased.

This warranty does not cover product subjected to abuse, misuse, accidental damage or tampering.

Power

- Main unit : use four (4) UM-3 or "AA" 1.5V battery
- Remote sensing unit : use two (2) UM-3 or "AA" 1.5V battery

Weight

- Main unit : 7.62 ounces (without battery)
- Remote sensing unit : 2.6 ounces (without battery)

Dimension

- Main unit : 5.35" x 3.54" x 1.38" (LxWxD)
- Remote sensing unit : 4.2" x 2.8" x 0.84" (L x W x D)

NOTE ON COMPLIANCE

This device complies with Part 15 of the FCC Rules. Operation is subject to the following two conditions: (1) This device may not cause harmful interference, and (2) This device must accept any interference received, including interference that may cause undesired operations.

Warning: Changes or modifications to this unit not expressly approved by the party responsible for compliance could void the user's authority to operate the equipment.

FCC :

NOTE: This equipment has been tested and found to comply with the limits for a Class B digital device, pursuant to Part 15 of the FCC Rules. These limits are designed to provide reasonable protection against harmful interference in a residential installation. This

equipment generates, uses and can radiate radio frequency energy and, if not installed and used in accordance with the instructions, may cause harmful interference to radio communications.

However, there is no guarantee that interference will not occur in a particular installation. If this equipment does cause harmful interference to radio or television reception, which can be determined by turning the equipment off and on, the user is encouraged to try to correct the interference by one or more of the following measures:

- Reorient or relocate the receiving antenna.
- Increase the separation between the equipment and receiver.
- Connect the equipment into an outlet on a circuit different from that to which the receiver is connected.
- Consult the dealer of an experienced radio/TV technician for help.

Company Name: Oregon Scientific, Inc.

Address: 19861 SW 95th Place, Tualatin, Oregon 97062, USA

Telephone Number: 1-800-853-8883

Name and model number of the product: Remote Thermo-Hygro BAR122HGA

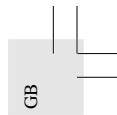

HOW TO STOP AN ALARM

To stop an alarm, you can use either press [24 hr  OFF] button or [AL] button.

Pressing [24 hr  OFF] will stop the alarm, which is still armed and will activate at the set time the following day.

If [AL] button is pressed instead, the alarm will be stopped and deactivated all together.

NOTE ON °C AND °F

The temperature display designation of °C or °F on the main display unit will override the display selection made on the remote sensor. Whatever the display unit of the remote sensor is, it will only apply to the remote sensor itself and the temperature unit will automatically be converted to the one of the main unit. (i.e. °F)

MAINTENANCE

When handled properly, this unit is engineered to give you years of satisfactory service. Here are a few product care instructions:

1. Do not immerse the unit in water. If the unit comes in contact with water, dry it immediately with a soft lint-free cloth.
2. Do not clean the unit with abrasive or corrosive materials. Abrasive cleaning agents may scratch the plastic parts and corrode the electronic circuit.
3. Do not subject the unit to excessive: force, shock, dust, temperature, or humidity. Such treatment may result in malfunction, a shorter electronic life span, damaged batteries, or distorted parts.

4. Do not tamper with the unit's internal components. Doing so will terminate the unit's warranty and may cause damage. The unit contains no user-serviceable parts.
5. Only use new batteries as specified in this instruction manual. Do not mix new and old batteries as the old batteries may leak.
6. Read this instruction manual thoroughly before operating the unit.

SPECIFICATIONS

Temperature Measurement

Main unit

Indoor Temperature measurement

Proposed operating range : -5.0°C to +50.0°C
(23.0°F to 122.0°F)

Temperature resolution : 0.1°C to (0.2°F)

Relative Humidity Operating range : 25% RH to 90% RH

Temperature Display in °F format



Remote thermo-hygro unit

Proposed operating range : -20.0°C to +60.0°C
(-4.0°F to 140.0°F)

Temperature resolution : 0.1°C (0.2°F)

Relative Humidity Operating range : 25% RH to 90% RH

The radio reception signal [] and the outline of the US-Map icon will start blinking to initiate reception automatically.

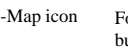
	- Strong
	- Weak
	- No signal
	- Receiving

HOW TO SET THE CLOCK MANUALLY

To set the clock manually, hold [MODE/SET] for three seconds. The hour digits will blink.

Hold and keep the respective button pressed to rapidly increase or decrease the value of the hour digits.

Press [MODE/SET] to confirm. The minute digits will blink.

Repeat the same procedure to set the minutes, year, month, day and display language.

Note: The time and date are displayed in 12-HOUR clock format. For the language display, you can choose among English (E), French (F) and Spanish (s).

For the US time zone, select the time-zone by using the [ZONE] button to toggle Pacific, Mountain, Eastern or Central.









If there is a setting you do not wish to change, simply press [MODE/SET] to bypass the setting.

When you are done, press [MODE/SET] to exit. The display will return to the mode last chosen.

HOW TO SET AND ARM THE ALARMS

The BAR122HGA has a daily alarm function.

To set an alarm:

1. Press [24 hr  OFF] once to enter the Alarm display mode.
2. Press and hold [24 hr  OFF] for three seconds. The hour digits will blink.
3. Enter the hour using [TIME / ] or [TIME / ] buttons.
4. Press [24 hr  OFF]. The minute digits will blink.
5. Enter the minutes using [TIME / ] or [TIME / ] buttons.
6. Press [24 hr  OFF] to exit. The [] icon for the alarm chosen will be displayed indicating the alarm set above is now armed.





You can also arm or disarm an alarm by pressing the [AL] button.

When an alarm is armed, it will go off at the set time.

The four-step crescendo function allows the alarm to start off gently and step up its intensity every 20 seconds for four times. Without interruption, the alarm will sound for a total of two minutes. If no key is pressed to turn off the alarm within these 2 minutes, the alarm will sound once more after 8 minutes.

WEATHER FORECAST FUNCTION

The unit is capable of detecting atmospheric pressure changes. Based on collected data, it can predict the weather for the forthcoming 12 to 24 hours. The effective range covers an area of 18 to 30 miles.

Indicator displays on the unit				
Forecast	Sunny	Slightly Cloudy	Cloudy	Rainy

NOTE:

1. The accuracy of a general pressure-based weather forecast is about 70% to 75%.
2. The weather forecasts from this unit are predictions that cover the next 12 to 24 hours. It may not necessarily reflect the current situation.
3. The "Sunny" icon, implies clear weather.

CALENDAR CLOCK DISPLAY MODES

The BAR122HGA supports 2 time display modes in the sequence of:

MODE 1. Hour-Minute-Second (of local time)

Month-Day (of local time)



MODE 2. Hour-Minute-Day of the Week (of local time)

Month-Day (of local time)



Each press on the [MODE/SET] button will toggle the display in the above order.

Note: The bottom line of the display will be replaced by the alarm time if the [24 hr OFF] button is pressed.

ABOUT RADIO RECEPTION

The BAR122HGA is designed to automatically synchronize its calendar clock when it is within range of the radio signal from the U.S. Atomic clock. When the BAR122HGA is new and initially set up, reception of the U.S. Atomic clock signal can take up to 72 hours.

When the unit is receiving radio signal, the RADIO RECEPTION signal will start to blink. A complete reception generally takes about 2 to 10 minutes, depending on the strength of the radio signal.

When the reception is complete, the RADIO RECEPTION signal will stop blinking. The strength of the reception will remain until the next scanning cycle takes place.

For better reception, place the clock away from metal objects and electrical appliances to minimize interference.

If you wish to disable the auto-reception feature, press the [TIME / ▽] button for three seconds. The radio reception signal [] and the outline of the US-Map icon will disappear. The unit will not respond to radio signals.

To enable the feature again, press the [TIME / ▽] (clock) button for three seconds.

The high-low displays are as follows:

Sequence	Respective Display
Pressing HI/LO once	Enters HI temperature display
Pressing HI/LO twice	Enters HI humidity display
Pressing HI/LO third time	Enters LO temperature display
Pressing HI/LO fourth time	Enters LO humidity display

To set a high or low temperature or humidity alarm:

1. Press [**HI/LO**], Channel-1 will be displayed.
2. Press [**▲**] to set the temperature or humidity limit. Each press will increase increments by one degree or percentage. Press and hold the button for a rapid-scrolling sequence by increments of five.

Note: The **temperature** range is from -50°C (-58°F) to +70°C (158°F).

If this is the first time you set the limits, the lower limit will start from -50°C (-58°F) and the upper limit +70°C (158°F). Otherwise, the reading will start from the temperature last selected.

The **humidity** range is from 2% to 98%.

If this is the first time you set the limits, the lower limit will start from 2% and the upper limit 98%. Otherwise, the reading will start from the humidity last selected.

3. Repeat the steps to set the upper temperature and humidity setting and the lower temperature and humidity settings.
4. When finished, press [**HI/LO**] to set another limit or wait 16 seconds and the unit will automatically return to the normal

display. The respective HI, LO or both indicators will be displayed to signify the status of the alarm.

If a channel other than channel-1 is selected, the display will switch to channel-1 and flash when the alarm activates. If left untouched, the alarm will activate for 1 minute. Press either [**CHANNEL**], [**MEMORY**], [**HI/LO**], [**▲**], [**ON/OFF**]

(TEMP % RH AL)

to momentarily stop the alarm. The alarm will activate again if the limit continues to exceed the set limit.

Note: If a second limit is passed while an alarm is active, the first alarm will complete its 1-minute cycle and the alarm will continue to activate for a second minute to indicate that a second limit has been surpassed.

To disable an alarm:

1. Enter the setting mode by pressing [**HI/LO**].
2. Then, press [**ON/OFF**].

The alarm has been disabled. Display will show “---” to indicate such deactivation and will not sound at the previously set limit.



To disable a sounding alarm:



- Press either [**CHANNEL**], [**MEMORY**], [**HI/LO**], [**▲**], [**ON/OFF**]



(TEMP % RH AL)

TEMPERATURE, HUMIDITY & PRESSURE TREND INDICATORS

The temperature-trend, humidity-trend and pressure-trend indicators show the trends of collected readings. Arrows indicate a rising, steady or falling trend.

Arrow indicator			
Temperature Trend	Rising	Steady	Falling

Arrow indicator			
Humidity Trend	Rising	Steady	Falling

Arrow indicator			
Pressure Trend	Rising	Steady	Falling

Note: If the reading goes above or below the measuring range of the main unit or the remote unit (stated in specification), the display will show “**HHH**” or “**LLL**”.

MAXIMUM AND MINIMUM TEMPERATURE AND HUMIDITY

The maximum and minimum recorded temperature and humidity readings will automatically be stored in the memory.

To display the maximum and minimum display memory:

1. Select the channel to be checked.
2. Press [MEMORY] once to display the maximum temperature and humidity and press [MEMORY] again to display minimum temperature and humidity. The respective indicators, MAX or MIN will be displayed.

To clear the memory:

- Press and hold [MEMORY] for 2 seconds.

If you press [MEMORY] now, the maximum and minimum recordings will have the same values as the current ones until different readings are recorded.

HOW TO USE CHANNEL-1 TEMPERATURE/ HUMIDITY ALARM

Upper and lower temperature and humidity limits for Channel-1 can be set so that an alarm activates when the limits are exceeded.

The high and low temperature and humidity displays are selected by sequentially pressing [**H/L**].

HOW TO READ THE KINETIC WAVE DISPLAY

The kinetic wave display shows the signal receiving status of the main unit. There are three possible forms:

The unit is in searching mode.	
Transmission data are securely registered.	
No signal received in search mode.	

REMOTE SENSOR SCANNING

The unit can be set to automatically scan and display readings from the remote sensors and indoor readings. When the remote-sensor scanning mode is active, the display will show the readings from one channel for about 4-second and then proceed to the next channel display.

To activate the remote-sensor scanning mode:

- Press and hold [CHANNEL] for 2 seconds.

To deactivate the remote-sensor scanning mode:

- Press either [CHANNEL], [MEMORY], [HI/LO], [▲], [ON/OFF]

(TEMP % RH AL)

COMFORT LEVEL INDICATORS

The comfort level indicators COM, WET or DRY will tell you if the current environment is comfortable, too wet or too dry.

The comfort indicator will appear on the display when the following conditions are satisfied:

Indicator displays on the unit	Temperature Range	Humidity Range	Shows that the Current Environment
 COM	20°C to 25°C (68°F to 77°F)	40%RH- 70%RH	Ideal range for both relative humidity and temperature
 WET	-5°C --+ 50°C (23°F - 122°F)	OVER- 70%RH	Contains excess moisture.
 DRY	-5°C --+ 50°C (23°F - 122°F)	Below 70%RH	Contains inadequate moisture
No Indicator	Less than 20°C(68°F) or More than 25°C (77°F)	40%RH to 70%RH	No comment

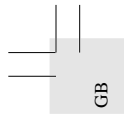

If no signals are received, blanks “---” will be displayed and the kinetic wave icon will not show.

To force a signal search:

- Press and hold [CHANNEL] & [MEMORY] for 2 seconds to enforce a 3-minute search.

This is useful in synchronizing the transmission and reception of the remote and main units.

Repeat this step whenever you find discrepancies between the reading shown on the main unit and that on the respective remote unit.

HOW TO CHECK REMOTE AND INDOOR TEMPERATURE & HUMIDITY

Display of readings from a remote sensor or the main unit is a one-step procedure. The remote sensor channel or the main unit display is indicated in a box under the kinetic-wave icon.

Kinetic-wave Icon				
Designated Display	Indoor Display	Remote Display Channel 1	Remote Display Channel 2	Remote Display Channel 3

To display temperature / humidity readings from the main unit:

- Press [CHANNEL] until a dot is displayed in the box under the kinetic-wave.

To display temperature / humidity readings from a remote sensor:

- Press [CHANNEL] until the appropriate remote sensor channel is displayed in the box under the kinetic-wave.

DISCONNECTED SIGNALS

If without obvious reasons the display for a particular channel goes blank, press [CHANNEL] & [MEMORY] to enforce an immediate search.

If that fails, check:

1. The remote unit of that channel is still in place.
2. The batteries of both the remote unit and main unit. Replace as necessary.

Note that when the temperature falls below freezing point, the batteries of outdoor units will freeze, which will lower their voltage supply and the effective range.

3. The transmission is within range and path is clear of obstacles and interference. Shorten the distance when necessary.

TRANSMISSION COLLISION

Signals from other household devices, such as door bells, home security systems and entry controls, may interfere with those of this product and cause temporary reception failure. This is normal and does not affect the general performance of the product. The transmission and reception of temperature and humidity readings will resume once the interference recedes.

LOW BATTERY WARNING

When it is time to replace batteries, the low-battery indicator will be displayed for the selected channel.

HOW TO USE THE TABLE STAND OR WALL MOUNTING

The main unit has a removable table stand which when connected can support the unit on a flat surface. Or you can remove the stand and mount the unit on a wall using the recessed screw hole.

The remote sensor comes with a wall mount holder and a table stand.

Main unit

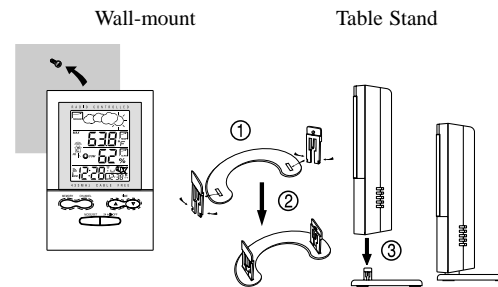

Remote unit

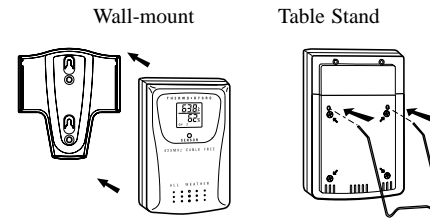

THE RESET BUTTON

This button is used when the unit is operating in an unfavorable way or malfunctioning. To return all user programmed settings to their original factory values, press [**RESET**] by using a blunt stylus to hold down the button.

GETTING STARTED

Once batteries are placed in a given remote sensor unit, it will start transmitting information at 40-second intervals.

For approximately a 3-minute duration, the main unit will automatically search for signals once batteries are installed. Upon successful reception, the individual channel temperature reading will be displayed on the second line and the respective humidity reading on the third line. The main unit will automatically update its readings at about 40-second intervals.



easier synchronization between the transmission and reception of signals.

4. Position the remote sensor and main unit within effective transmission range, which, in usual circumstances, range of 300 feet (100 meters) under ideal conditions.

Note that the effective range is vastly affected by the building materials and where the main and remote units are positioned. Try various set-ups for best result.

Though the remote sensors are weather resistant, they should be placed away from direct sunlight, rain or snow.

BATTERY INSTALLATION: MAIN UNIT

1. Gently lift up the tab on the battery compartment door.
2. Insert four (4) UM-3 or "AA" size batteries.

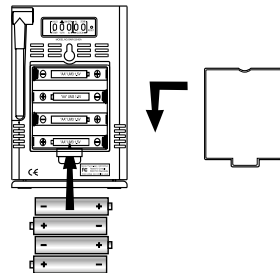

3. Replace the battery compartment door.

BATTERY AND CHANNEL INSTALLATION: REMOTE UNIT

The remote thermo-hygro sensor unit uses two (2) UM-3 or "AA" size batteries.

Follow these steps to install / replace batteries:

1. Remove the screws on the battery compartment.
2. Select the channel number on the [CHANNEL] slide switch.
3. Select the temperature display unit on the °C/°F slide switch.

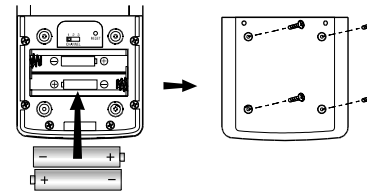

4. Insert the batteries strictly according to the polarities shown therein.
5. Replace the battery compartment door and secure its screws.

Replace the batteries when the low-battery indicator of the particular channel lights up on the main unit. (Repeat the steps described in section "BEFORE YOU BEGIN")

Note that once a channel is assigned to a remote unit, you can only change it by removing the batteries or resetting the unit.

**FEATURES: REMOTE THERMO-HYGRO
SENSOR**

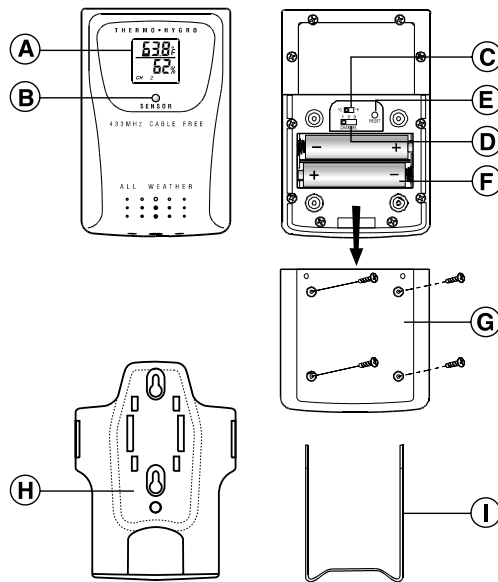

- A. TWO-LINE LCD**
Displays the current temperature and humidity monitored by the remote unit
- B. LED INDICATOR**
Flashes when the remote sensor transmits a reading
- C. °C/°F SLIDE SWITCH**
Selects between Centigrade (°C) and Fahrenheit (°F)
- D. CHANNEL SLIDE SWITCH**
Select the remote sensor Channel 1, Channel 2 or Channel 3
- E. RESET**
Returns all user programmed settings to original factory set values
- F. BATTERY COMPARTMENT**
Accommodates two (2) UM-3 or AA-size batteries
- G. BATTERY DOOR**
- H. WALL-MOUNT HOLDER**
Supports the remote unit in wall-mounting
- I. REMOVABLE TABLE STAND**
For standing the remote unit on a flat surface

BEFORE YOU BEGIN

- For best operation,
1. Assign different channels to different remote units.
 2. Insert batteries for remote units before doing so for the main unit.
 3. Place the main unit as close as possible next to the remote unit, reset the main unit after installing batteries. This will ensure

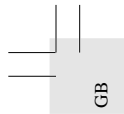

A. FRONT DISPLAY

A four line easy-to-read LCD

A1. WEATHER FORECAST WINDOW

Graphically illustrates a weather forecast

B. [] BATTERY-LOW INDICATOR

Activates when the remote-sensor or main unit battery power is low

C. [] RADIO-RECEPTION SIGNAL

Indicates the condition of radio reception

D. [MEMORY] BUTTON

Displays minimum and maximum temperature and humidity readings and erases memory data

E. [CHANNEL] BUTTON

Toggles between the remote sensor channels

F [MODE/SET] BUTTON

Changes the display mode of the clock and alters time/date setting

G. US - TIME ZONE MAP ICON

Displays Pacific (P), Mountain (M), Eastern (E) or Central (C) time-zone

H. [] ALARM-ON ICON

Appears when the alarm is activated

I. [(())] ALARM ICON

Appears when the alarm time is displayed

J. [TIME / ] BUTTON

Decrease the value of a setting

K. [TIME / ] BUTTON

Advances the value of a setting

L. [24 hr  OFF] BUTTON

Displays the alarm time or changes the alarm set time

**TEMPERATURE & RELATIVE HUMIDITY ALARM :
(for Channel - 1 only)**

M. [ON/OFF] BUTTON

Enables / disables HI/LO temp alarm and HI/LO % RH alarm

N. [HI/LO] BUTTON

- Set the upper or lower temperature and humidity alarm limits
- Confirms alarm settings

O. [] BUTTON

Advances the value of the settings for the HI/LO temperature and humidity alarm

CLOCK :

P. [AL] BUTTON

Enables or disables the daily alarm

Q. [ZONE] BUTTON

Toggles between the 4 US time-zones : Pacific, Mountain, Eastern or Central

R. [RESET] BUTTON

Returns all settings to default values

S. WALL-MOUNT HOLE

For mounting the unit on a wall

T. BATTERY COMPARTMENT

Accommodates four (4) UM-3 or "AA" size batteries

U. REMOVABLE TABLE STAND

For standing the main unit on a flat surface

V. ANTENNA FOR RECEPTION OF REMOTE

**DIGITAL WEATHER FORECASTER
WITH REMOTE THERMO-HYGRO
SENSOR AND RADIO CONTROLLED
CLOCK**

MODEL NO.: BAR122HGA

USER'S MANUAL

INTRODUCTION

Congratulations on your purchase of the Weather forecaster with cable free sensor and radio-controlled calendar clock BAR122HGA.

This unit has a large four-line liquid crystal display (LCD) for displaying weather forecast information, in/outdoor temperatures and relative humidity, radio frequency (RF) controlled calendar clock and daily alarm. Also, the main unit can support up to three remote sensors.

Other features include day of week display in three abbreviated languages, crescendo alarm, and interchangeable clock display modes.

MAIN FEATURES: MAIN UNIT

