



"When The Game Is On The Line"

Model FS-77

7' x 7' Collegiate Fielder's Screen



INTRODUCTION

These instructions outline the assembly and use of the **Collegiate Fielder's Screen Model FS-77**. If you need additional information or support in the assembly and use of the Collegiate Screen you can reach the Jaypro Sports customer support team, Monday through Friday, 8:00 AM to 5:00 PM Eastern time at 800-243-0533.

Replacement nets are available through your dealer or by calling Jaypro Sports.

SAFETY

All netting deteriorates through use and exposure to the elements. For safe operation and continued high performance from this equipment, inspection and maintenance must be performed before each use. Inspect the net for broken mesh, tears, or other signs of weakness. Questionable nets should be immediately removed from service and replaced.

Use of this equipment other than intended, may be hazardous. Alteration or modification of equipment may be hazardous. For repair or replacement, please call your dealer or Jaypro Sports.

EQUIPMENT AND MATERIALS

You will need the following tools to put the Collegiate Screen together.

Allen Wrenches

Wrench Set

Rubber Mallet

Optional -Loctite Thread Lock

BEFORE YOU START

Check to confirm that you're Collegiate Fielder's Screen has shipped with all hardware. If any hardware or components are missing, contact the Jaypro Customer Support Team.

ITEM	QTY	DESCRIPTION	ITEM	QTY	DESCRIPTION
1	1	LEG BASE	9	2	TUBE CAP
2	1	WHEEL BASE	10	6	M8 SCREW
3	1	BASE PIPE	11	6	M8 NUT
4	2	UPRIGHT	12	2	M12 NUT
5	1	TOP CROSSBAR	13	2	M12 WASHER
6	2	WHEEL BRACKET	14	2	M12 x 65mm SCREW
7	2	WHEEL	15	2	SELF TAPPING SCREW
8	1	NET			

ASSEMBLY

1. Lay out frame pipes as shown in **Figure 1** and assemble together by using fasteners shown in **Figure 3** Loctite may be used on these screws to ensure assembly.
2. Once the frame is completely assembled, fully tighten all fasteners.
3. Slip net onto frame.
4. Push end plugs **Item 9** into leg base see **Figure 1**
5. Put wheels onto wheel bracket. Do not over tighten, wheels should turn freely. See **Figure 4**. Wheel bracket fits into wheel base as shown in **Figure 2** and is secured with one self tapping screw shown in **Figure 4**.

Figure 1 Model FS-77 Included Components and Hardware

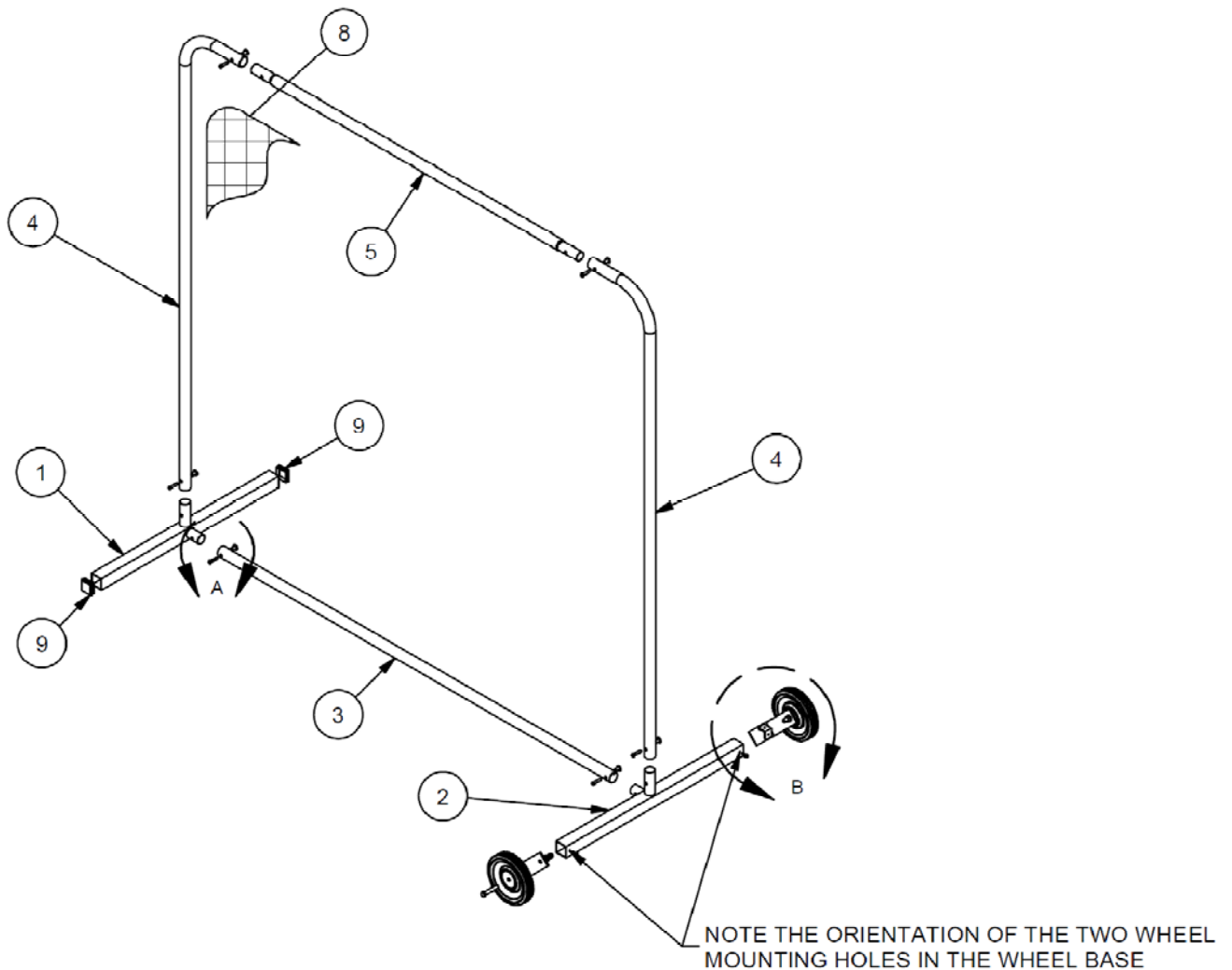

Figure 2 Wheel Orientation

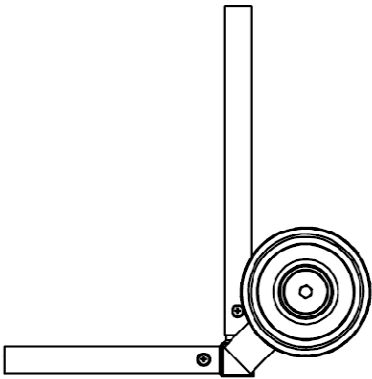

Figure 3 Tube Assembly

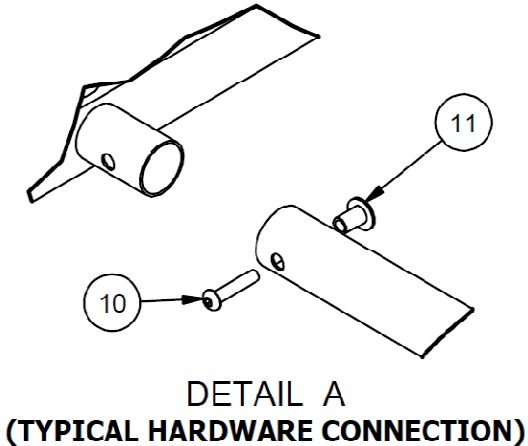

Figure 4 Wheel Assembly

