

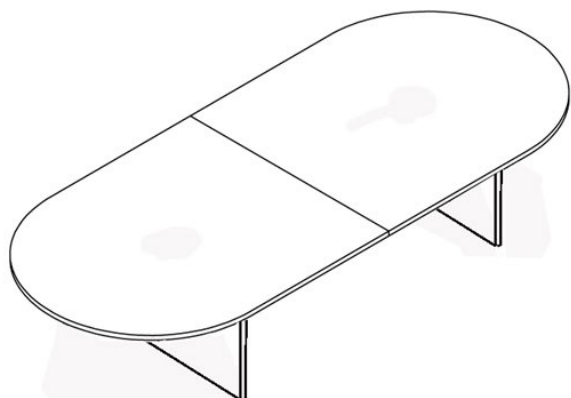









Modern Office
6900 Shady Oak Road, Ste 120
Eden Prairie, MN 55344
Phone: 800.443.5117
(In MN): 952-941-2837
Fax: 952-949-9816
www.modernofficefurniture.com

Oval Racetrack Expandable Conference Table Series



ASSEMBLY INSTRUCTIONS

PARTS LIST

Part	Part
	
Wood Dowel	
	
Cam Post	Leveler
	
Cam Fastener	Large Brackets
	
Cap	

TIP: Assemble table in a carpeted area, near the place of use. Use cardboard for protection if no carpet available.

1.) Lay the table tops face down on the floor. Using the large flat brackets and screws, connect the table tops together.

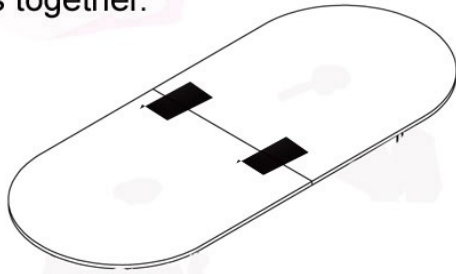

2.) Next, attach the table support to the table using the wooden dowels and cam locks and pins provided.

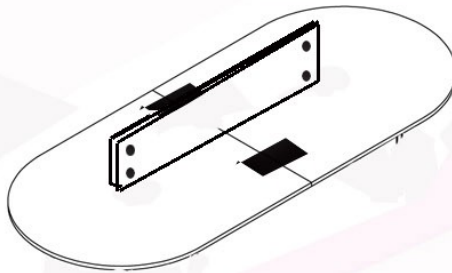

3.) Now you will attach the first table base. Locate the cam pin holes on the top of the base, as well as the round cam pin holes on the inside of the base towards the top. Insert cam pins into the table top and cam locks into the round cam holes, making sure to position the cam lock with the open end facing the cam pin hole. Next, insert the wooden dowels and cam pins into the base for the support. Fit base over the cam pins to connect the top and make sure dowels and pins enter the holes along the edge of that support. Turn all cam locks to secure.

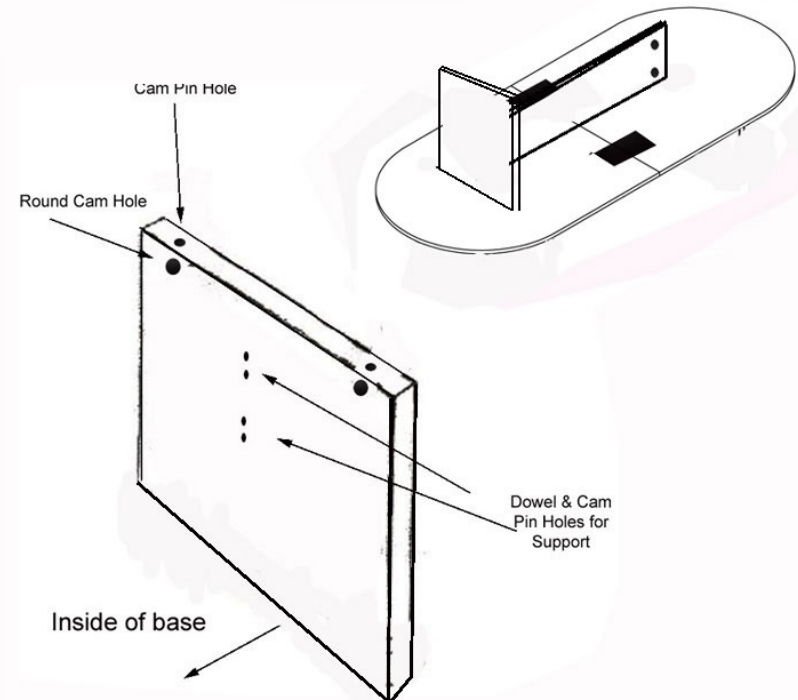

4.) Repeat Step 3 for other table base.



5.) Lastly, using 2-3 people, carefully turn table upright, making sure to support the bases of the table as it is being turned over.

6) Cover round cam locks with caps provided.

For tables with adder sections (ie: 12', 16' etc)

-Repeat assembly process detailed in previous steps to assemble & attach the adder table top, support and base.

Care Instructions:

-Clean with damp, soft cloth. Use a mild detergent & water mix, such as Dawn or Palmolive if needed.
-DO NOT USE waxed based products such as Pledge. Waxed bases products can leave a waxy residue on the surface.