

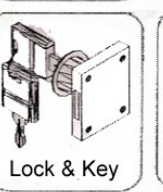

Since 1978
 6900 Shady Oak Road, Ste 120 (In MN): 952-941-2837
 Eden Prairie, MN 55344 Fax: 952-949-9816
 Phone: 800.443.5117 www.modernofficefurniture.com

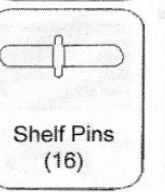
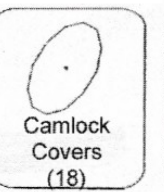
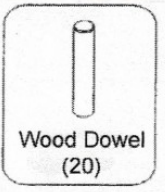

Please follow the steps below for ease in assembly:

- 1.) Assemble on a smooth, clean surface to prevent scratches.
- 2.) Screw in all camlock pins and insert all wood dowels in both SIDE PANELS, BACK PANEL and the TOP and BOTTOM SHELVES.
- 3.) Attach the BOTTOM TRIM PIECE to the BOTTOM SHELF. Insert camlocks and tighten.

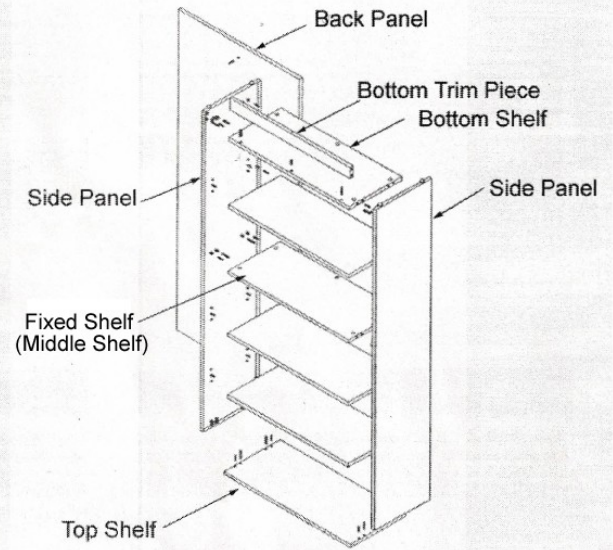

- 4.) Assemble the bookcase on its side. Begin by attaching the base with the trim piece by placing it over the cam pins and inserting the cam locks. **DO NOT YET TIGHTEN.**
- 5.) Repeat process with MIDDLE SHELF, making sure that the exposed cam lock holes will face downward. Again, **DO NOT YET TIGHTEN.**
- 6.) Next, attach back panel of bookcase by placing holes over cam pins in SIDE PANEL and fasten. **Now, tighten all cam locks on BOTTOM and MIDDLE SHELVES.**
- 7.) Attach opposite SIDE PANEL to BOTTOM SHELF with TRIM PIECE, MIDDLE SHELF and BACK PANEL in same manner. Screw in the Gliders to the underside of the bookcase. Further adjusting of the gliders may be required after assembly, to level the bookcase.
- 8.) Make sure all connections are properly tightened and then carefully stand the bookcase upright. Insert adjustable shelf pins at desired height for the ADJUSTABLE SHELVES. Place plastic covers over cam locks.



Since 1978
6900 Shady Oak Road, Ste 120 (In MN): 952-941-2837
Eden Prairie, MN 55344 Fax: 952-949-9816
Phone: 800.443.5117 www.modernofficefurniture.com

Finished Look:



To Attach the Lower Doors:

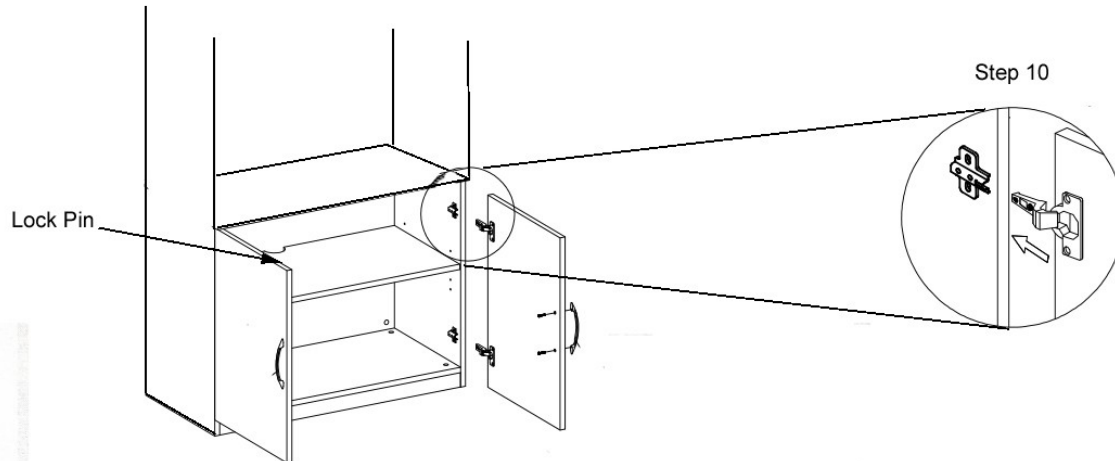

- 9.) Attach 4 hinges to inside of bookcase and to the 2 doors using screws provided.
- 10.) Connect the two halves of the hinges as shown in the drawing.
- 11.) Attach the lock pin to the inside of the left side door. You will find a routed out noie on the underside of the fixed shelf. The lock pin should fit inside when the button is depressed.
- 12.) Attach door pulls using 4 screws provided.

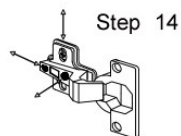

- 13.) Carefully turn bookcase upright if you have not done so already.
- 14.) Once upright, align the bottom & upper doors by adjusting the hinges with a Phillips screwdriver, as shown in the drawing above.