

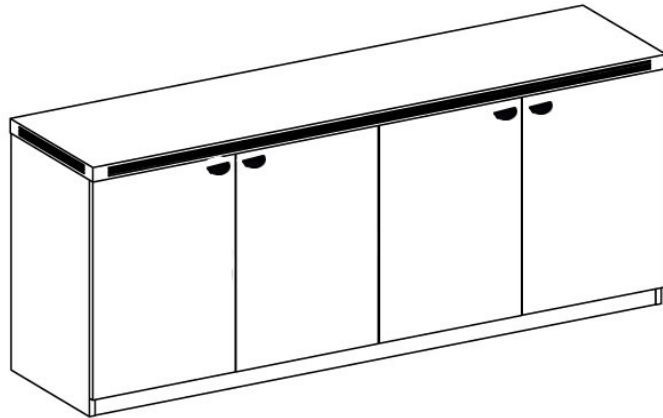









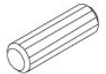

Modern Office  
 6900 Shady Oak Road, Ste 120  
 Eden Prairie, MN 55344  
 Phone: 800.443.5117  
 (In MN): 952.941.2837  
 Fax: 952.949.9816  
[www.modernofficefurniture.com](http://www.modernofficefurniture.com)

**Y9749 - 4-Door Mocha Storage Credenza**  
**Y10315 - 4-Door Maple Storage Credenza**  
**Y10398 - 4-Door Cherry Storage Credenza**



# Assembly Instructions

## PARTS LIST

Part	Part
<b>A</b>  Wood Dowel	 Shelf Pin
<b>B</b>  Cam Post	 Plunger Lock
<b>C</b>  Cam Fastener	 Leveling Glide
 Drawer Pull & Screws	 Shallow Cover
 Lock & Key Set	 Deep Cover

You will also receive 4 "Inside Door" Hinges - (Short Depth) and 4 "Outside Door Hinges" - (Long Depth)

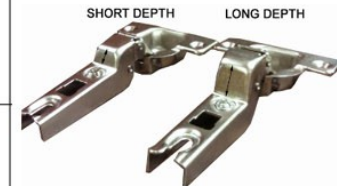

Screws for hinges are located inside the hinges

1.) First step, lay all of the panels out and attach/insert the hardware. Cam Posts (or Cam Pins) fit in the smallest holes. Wooden dowels fit in the larger holes. Cam Fasteners (or Cam Locks) fit in the holes adjacent to the Cam Posts. Attach 6 leveling glides to the Left & Right side panels. Also attach the hinge plates to the Left & Right side panels, as well as the center upright panel. The holes for the hinges plates will be piloted near the front of each panel. Leave screws somewhat loose for ease of adjustment later on. Also, attach the hinges to the 4 doors. Lastly, attach the door pulls to the doors using the screws provided. Save attaching the locks for the last step.

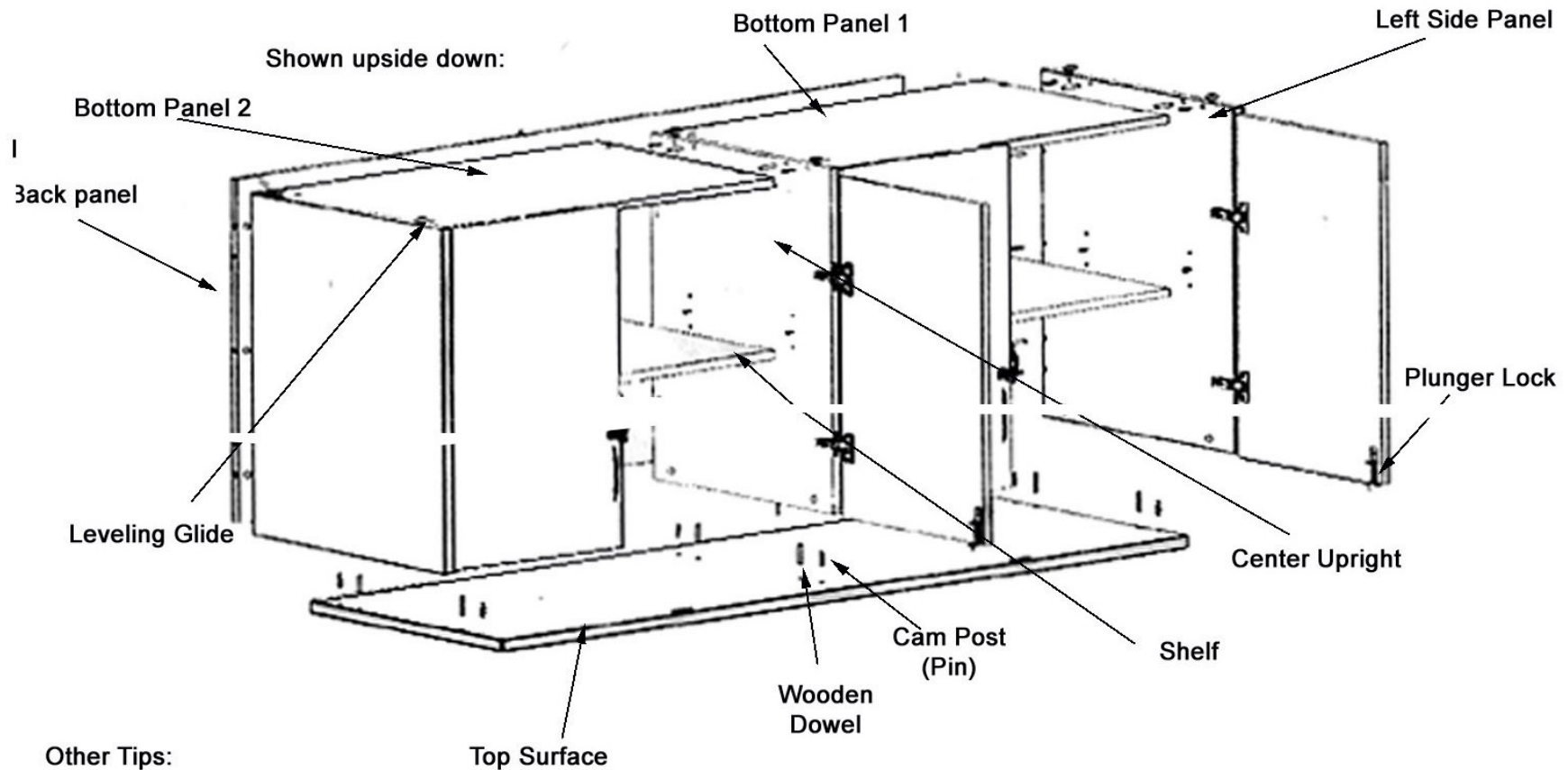

**Other Tips:**

- A second person will be needing to help hold some of the panels in place during assembly and to help turn the unit over once assembled.
- Assemble in a carpeted area near where the unit will be used.
- You will need a Phillips Screwdriver to assemble this product.
- Be sure to attach Long Depth Hinges to the "Outside Doors" and Short Depth Hinges to the "Inside Doors"

- 2.) Assemble unit by laying the back panel, finished side down on the floor. Then, attach the center upright using the cam posts, fasteners and dowels provided.
- 3.) Next, attach either Bottom Panel 1 and Left Side Panel, or Bottom Panel 2 and Right Side panel using same hardware.
- 4.) Then repeat the same process for the other Bottom Panel and Side Panel.
- 5.) Attach the Top Surface using same hardware. The shell of the unit should now be complete. Carefully turn the unit upright.
- 6.) Mount the shelves using the Shelf Pins included.
- 7.) Your next step is to attach the doors using the hinges. Attach the hinges to the doors if you have not done so already. You will need to align the doors by turning the set screw with your Phillips screwdriver. See diagram below.
- 8.) Your last step is two attach the locks. Attach the lock core with the wood screws provided. Attach the Plunger Lock on doors as shown, again using wood screws provided. The plunger should align with the routed out holes in the underside of the Top Surface.

*To lock doors: Close door with plunger lock and push in Plunger. Close the other door and turn the key.*

*To unlock: Turn the key to unlock first door, then hit the red button on the Plunger Lock to release the plunger.*

Order of Panel Assembly

