





# Assembly Instructions

## Hardware List

<b>A</b>  (M8x16) Qty 3	<b>B</b>  Allen Wrench, 6MM Qty 1	<b>C</b>  (M6x12) Qty 4	<b>D</b>  Allen Wrench, 5MM Qty 1	<b>E</b>  Arm width adj. knob Qty 2		
---	---	---	---	---	--	--

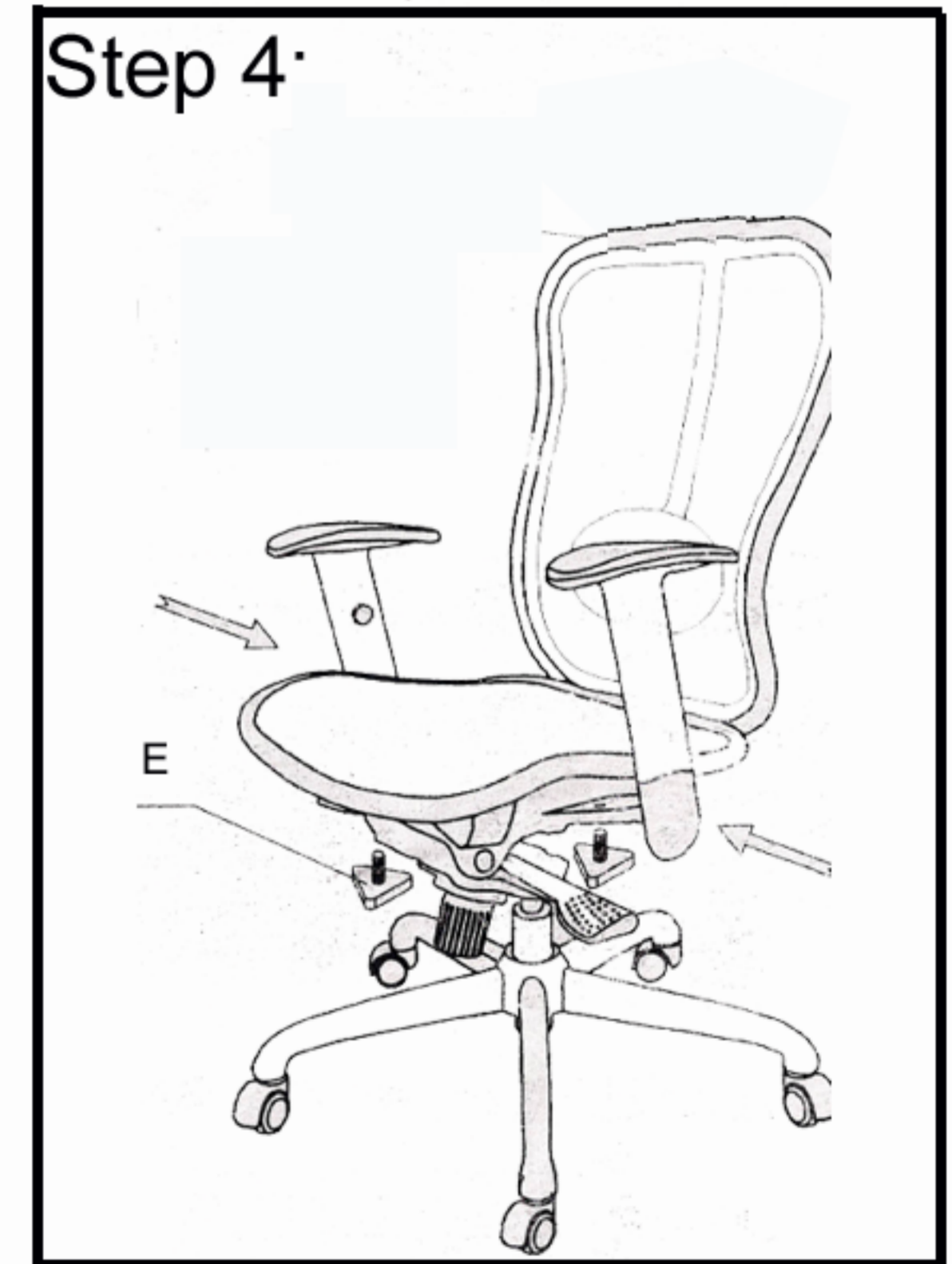
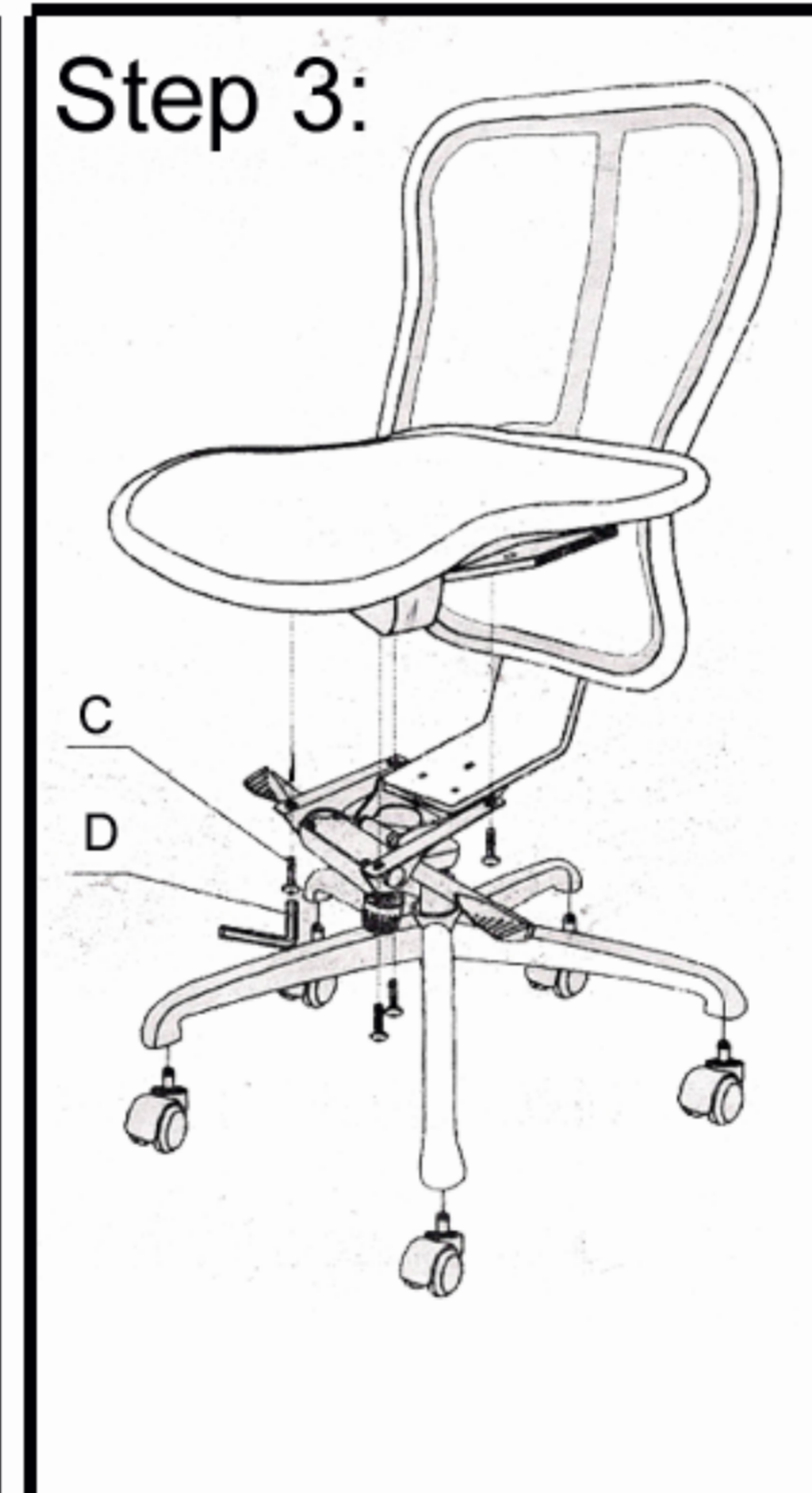
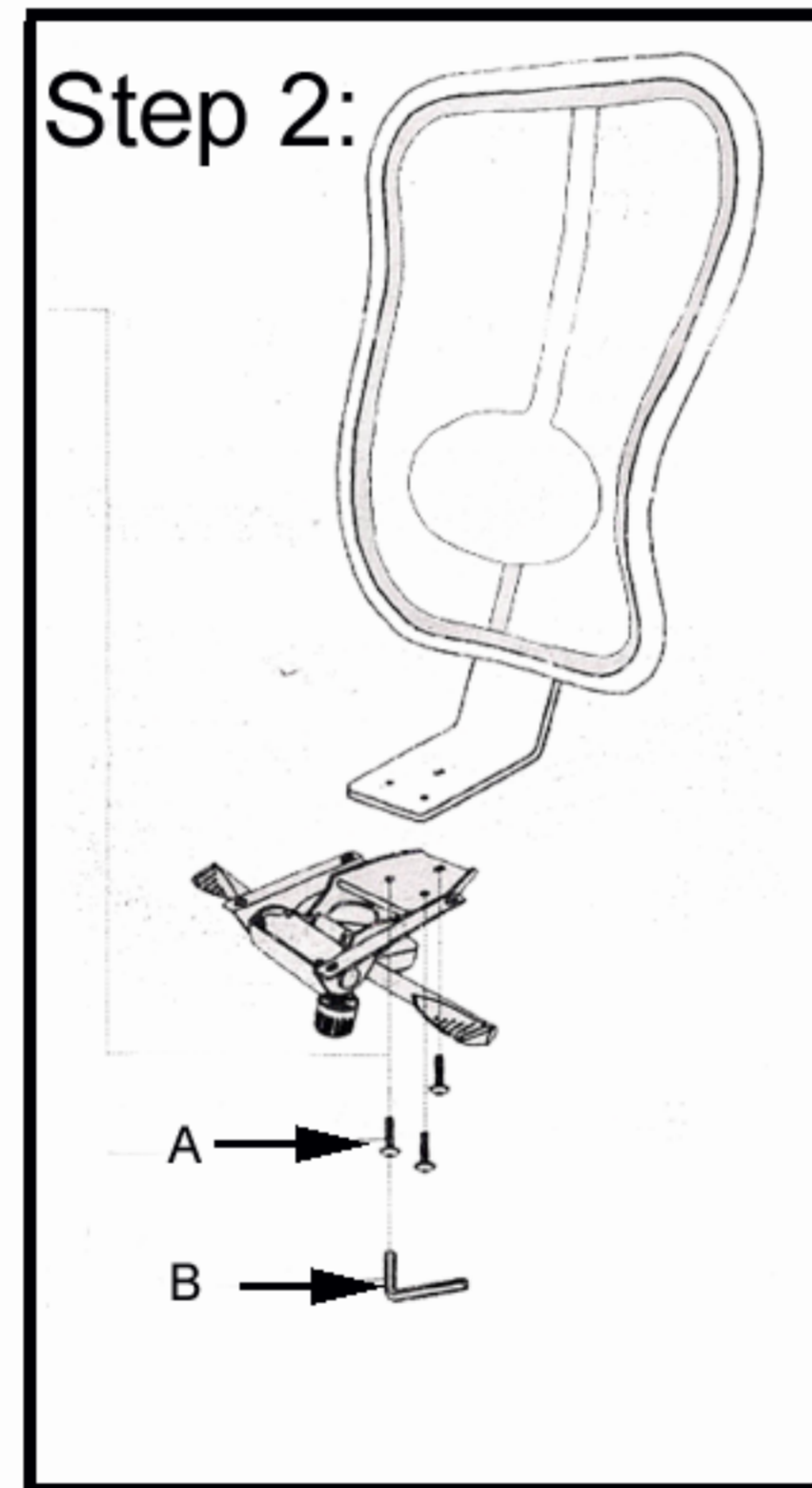
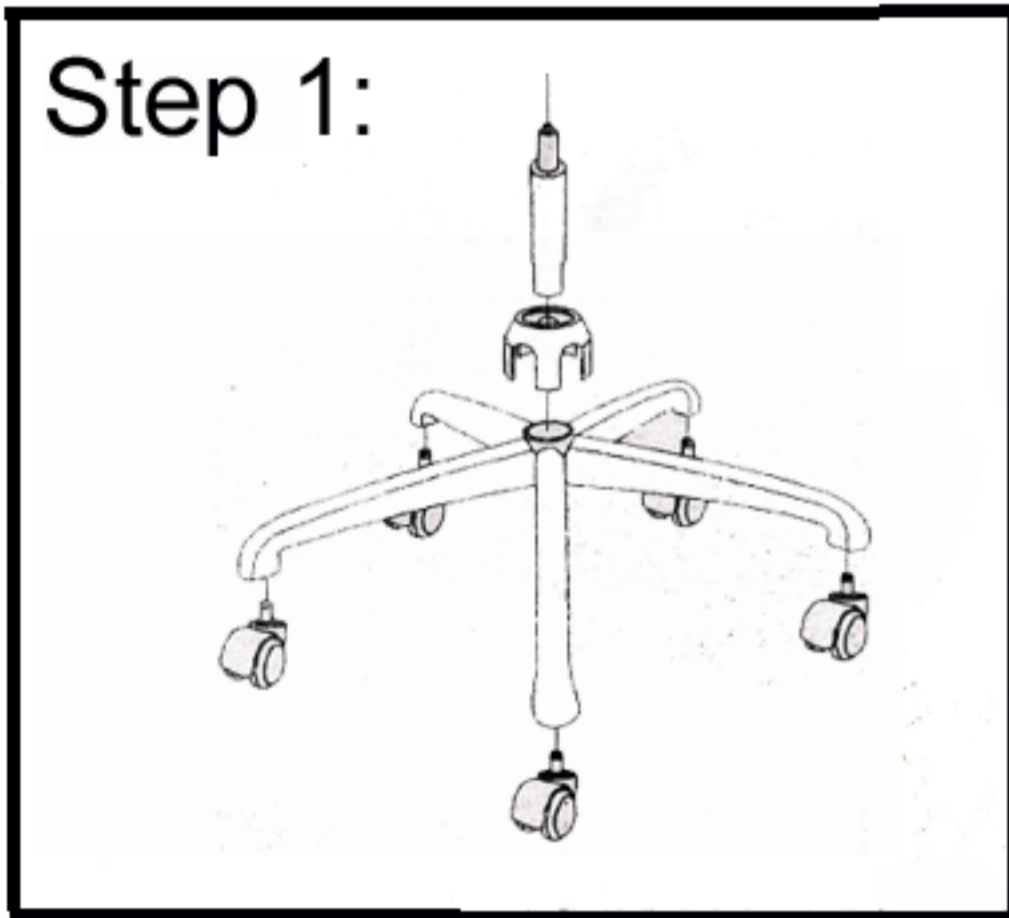

**CM-F85B**