

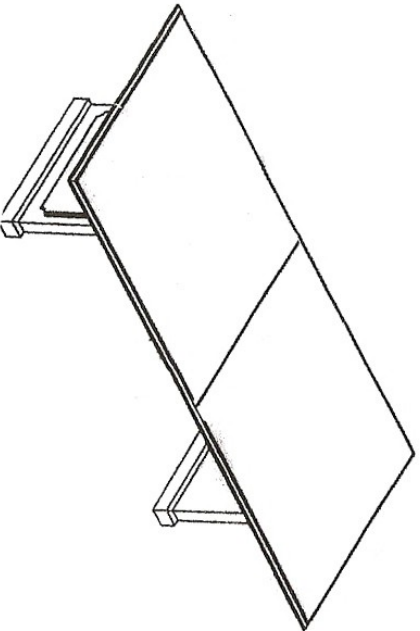







# Y9442

## Franklin Traditional Table



### ASSEMBLY INSTRUCTIONS

## PARTS LIST

Part		Part	
Wood Dowel		Leveler	
Cam Post		Large Brackets	
Cam Fastener		Small Brackets	
Cap			

1.) The table will come with two bases. The bases have wood moldings on one side and holes for the pins on the other. The bases are interchangeable and will be assembled with the moulding side face out.

2.) Using the small brackets on the end bases, center the small brackets over the grooved cut-outs at the end of each base. The drill 4 screws in the center of each bracket to connect the bracket to the legs. Use the four center holes of each bracket only.

## Step 2

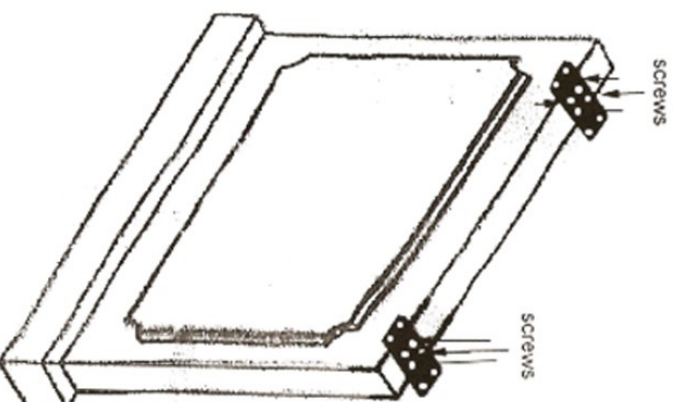

3.) Next, put the metal pins into the holes of the bases and place the cam locks into the pre-drilled holes of the support beams. Line up the holes of support beams to the bases so that the pins go into the support beam holes. Once in place, tighten the cams with a Phillips screwdriver by turning until locked and secured into place.

## Step 3

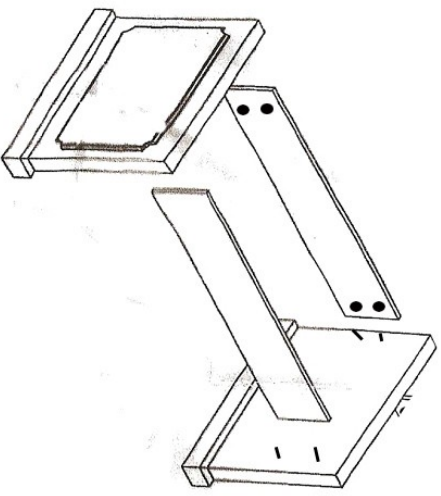



Modern Office  
6900 Shady Oak Road, Ste 120  
Eden Prairie, MN 55344  
Phone: 800.443.5117  
(In MN): 952.941.2837  
Fax: 952.949.9816  
[www.modernofficefurniture.com](http://www.modernofficefurniture.com)

4.) Next, place all of the wooden dowels into the holes on the bases and support beams. The dowels will line up with the holes on the underside of the table tops.

5.) Then, using two people, take each table top and line up the dowels with the holes on top of the bases and support bars and set on top of the base assembly. *Special Note: Since some floors are slightly uneven, you may have slightly twist and shift the bases to get the tops to line up properly.*

6.) Connect the two table tops together using the flat brackets and screws.

7.) Your next step is to take the remaining screws and drill them upward into the undersides of the table tops from the table base brackets. You will be using the 4 holes on the outside edges of the brackets.

8.) Lastly, cover the cams with the plastic caps provided.

## Step 6:

