

Glass Front Reception Desk

MJ/FL/ML/WH/BK2969

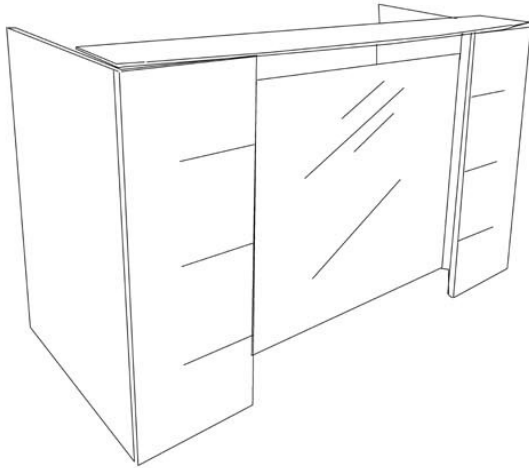

ASSEMBLY INSTRUCTIONS

PARTS LIST

Part	Part	Part
 Wood Dowel	 Cap	 Clear Rubber Washer
 Cam Pin	 Leveling Glide	
 Cam Lock	 Grommet	
 Metal disc	 Metal dowel	



Modern Office
6900 Shady Oak Road, Ste 120
Eden Prairie, MN 55344
Phone: 800.443.5117
(In MN): 952-941-2837
Fax: 952.949.9816
www.modernofficefurniture.com

Helpful Tips:

Assemble on carpet or on cardboard box to avoid damage during assembly.

Assemble in area of planned use for the desk. Avoid dragging assembled desk.

Tools needed:

- Phillips Screwdriver
- A helper

- 1.) Locate the two front panels and lay them face down. Insert cam pins and leveling glides.
- 2.) Locate the spacers for the front panels and insert dowels and cam locks.
- 3.) Using a screwdriver, turn the cam locks on the spacers clockwise to lock/attach the spacers to the front panels.

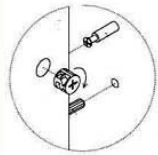

Modern Office
6900 Shady Oak Road, Ste 120
Eden Prairie, MN 55344
Phone: 800.443.5117
(In MN): 952-941-2837
Fax: 952.949.9816
www.modernofficefurniture.com

- 4.) With a helper, set the glass front panel, smooth side down, on front panels as shown. Line up the holes of the panel with the holes on the spacers.

- 5.) Next, insert the metal threaded dowels into the holes. Then set one clear rubber washer over each dowel. Finally, screw the chrome metal discs over the dowels.

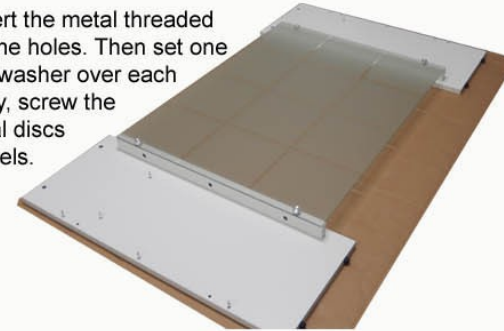

- 6.) Next, locate the desktop and insert all of the hardware.

- 7.) Insert desktop like shown. Insert all cam locks and PARTIALLY TIGHTEN. DO NOT YET FULLY TIGHTEN.





Modern Office
6900 Shady Oak Road, Ste 120
Eden Prairie, MN 55344
Phone: 800.443.5117
(In MN): 952-941-2837
Fax: 952.949.9816
www.modernofficefurniture.com



8.) Locate one of the side panels, insert hardware and attach to front panels and desktop. **DO NOT FULLY TIGHTEN YET!**

9.) Repeat process with other side panel.

10.) Now, tighten down all cam locks on desktop, side panels and front panels.

11.) With a helper, carefully turn the desk upright.



Modern Office
6900 Shady Oak Road, Ste 120
Eden Prairie, MN 55344
Phone: 800.443.5117
(In MN): 952-941-2837
Fax: 952.949.9816
www.modernofficefurniture.com



12.) The next step is to attach the glass counter top. The counter top will have metal discs adhered already. Turn the counter disc side up and insert one cam pin per disc.

13.) Set counter top on desk, lining up the cam pins with the holes.

14.) Insert cam locks that align with those cam pins, and fully tighten down.

15.) Insert the desktop grommets and any cam lock covers as your last step.



Care & Maintenance:

Use a damp and/or soft cloth to clean. Regular glass cleaner can be used on the smooth, non-frosted side of the glass.

Questions?

Call us at 1-800-443-5117
Mon-Fri, 8:30-5:00 CT



Box/Box/File Pedestal

MJ/FL/ML/WH2066



Install Instructions

PARTS LIST

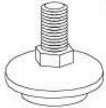
Part	Part
 Bolt	 Drawer Pull & Screws
 Keys	 Leveling Glide

- 1) Install 4 leveling glides and level the file
- 2.) Install drawer pulls with screws provided.

To attached under desk (optional):

- 1.) Remove 1 or 2 of the box drawers by locating the black tabs in the left & right side of the drawer. Pull up on one tab, push down on the other to unlock from the track and remove drawer.
- 2.) Use 4 bolts provided to go through the top of the file into the threaded holes on the underside of the desk.