



Modern Office
6900 Shady Oak Road, Ste 120
Eden Prairie, MN 55344
Phone: 800.443.5117
(In MN): 952.941-2837
Fax: 952.949.9816
www.modernofficefurniture.com

8' Glass Conference Table



ASSEMBLY INSTRUCTIONS

Applies to Oval or Rectangular Tables

PARTS LIST

 Stopper x 4	 Long Bolt x 4
 Medium Bolt x 4	 Short Bolt x 4
 Metal Spacer x 4	 Allen Wrench
 Small Cake x 4	 Leveling Glide x4

1.) Install the leveling glide feet on the bases



2

2.) Next, you will install the support beams to the bases. Hook the support beams into the bases so that they fit together like shown in the *picture below:

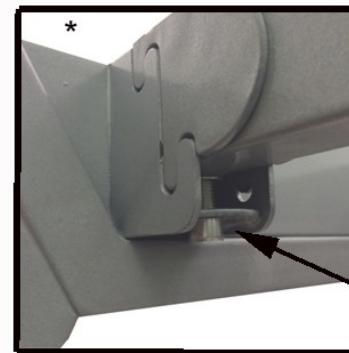

3) Use the Long Bolt to connect the beams to the legs. Connect as shown in the picture on the left.

Long Bolt

3

4.) Now, attach the 4 small cakes to the center of the support using the Medium Sized Bolts.



4

5.) Next, using 2-4 people, carefully set the glass down on top of the bases. Try to align the Large Cakes (that are adhered to the underside of the glass table top) to holes in the bases. You may want to have a few people hold the glass steady for the next step.



5

6.) The next step is to attach the glass table tops by using the Short Bolts and Metal Spacers to connect the Large Cakes of the table top to the bases. You may need helpers to help shift the table to get all of the holes to align.

NOTE: Do NOT fully tighten down the screws until all 4 Large Cakes have been connected. Only partially screw in the bolts one at a time. Tightening down the screws all of the way before connecting all 4 can put stress on the glass.

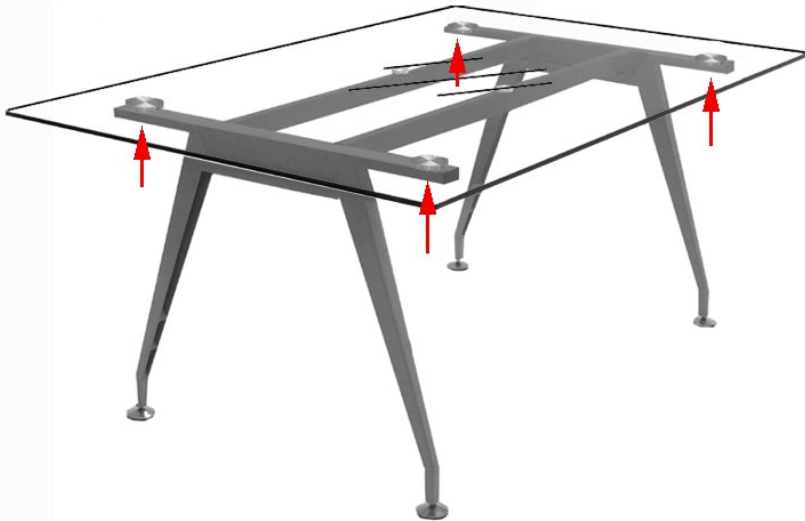

6

Place a Metal Spacer inside the tube of the base. Then, use a Small Bolt and place it through the hole on the underside of base with your Allen Wrench. Screw the bolt in partially. Repeat this process 3 more times for the other corners of the table.

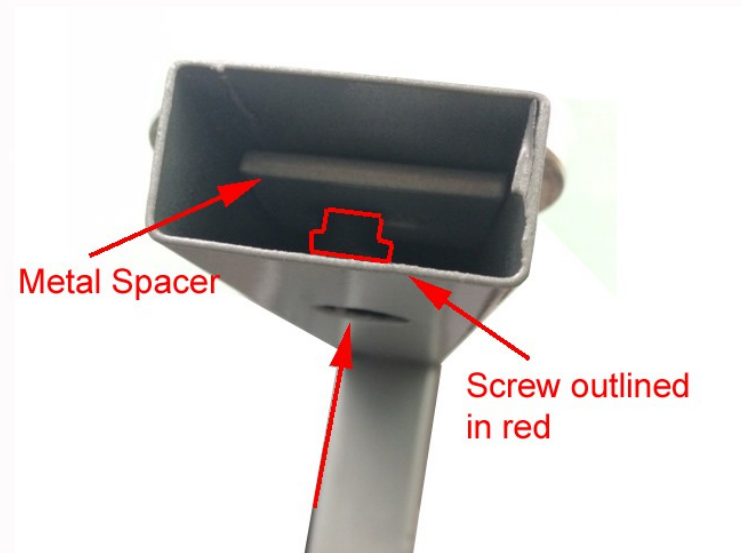

Once all 4 points are connected, tighten down the screws all of the way.

7

7.) Lastly, place the black plastic stoppers in the top of the bases at the 4 corners.

