

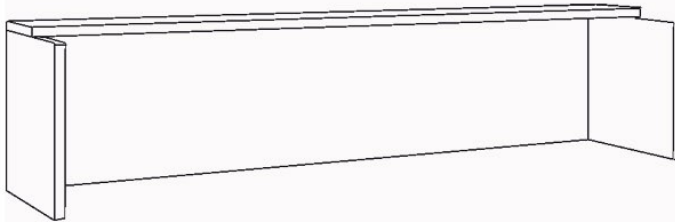







Modern Office
6900 Shady Oak Road, Ste 120
Eden Prairie, MN 55344
Phone: 800.443.5117
(In MN): 952.941.2837
Fax: 952.949.9816
www.modernofficefurniture.com

66" & 71" White Desktop Risers



WH2095 & WH2090

PARTS LIST

Part	Part
 Wood Dowel	 Shallow Cover
 Cam Pin	
 Cam Lock	 Deep Cover

Assemble on a smooth, clean surface to prevent scratches.

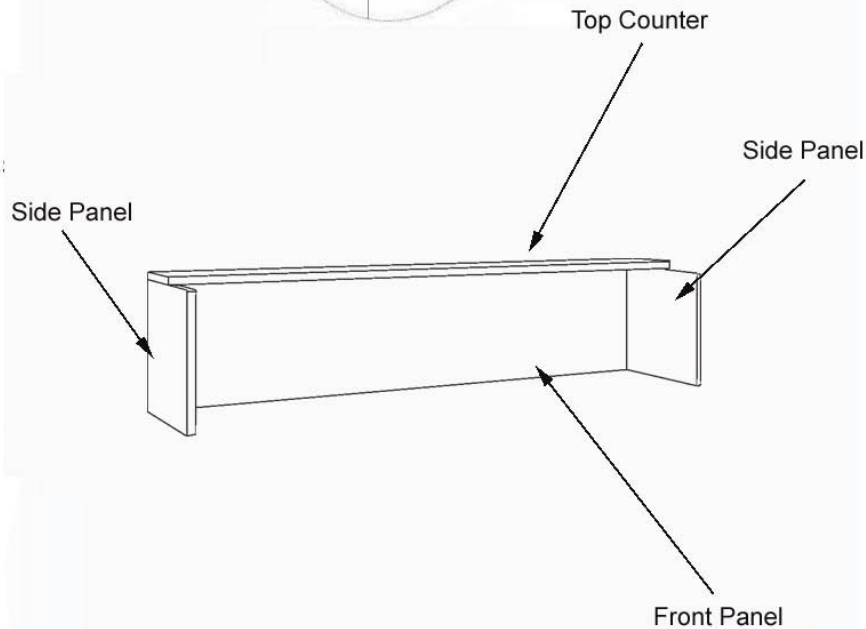
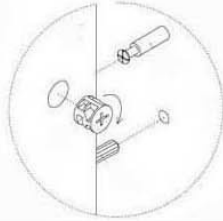

- 1.) First, attach FRONT PANEL to one of the SIDE PANELS using the cam lock and cam pin sets provided. DO NOT YET FULLY TIGHTEN DOWN THE CAM LOCKS. That will be towards the end.
- 2.) Next, attach the other SIDE PANEL using same method.
- 3.) Now, insert any/all wooden dowels, cam locks and pins into the FRONT PANEL to attach the TOP COUNTER.
- 4.) Once all panels are connect, fully tighten all cam locks.
- 5.) Place in area of intended use and use covers to cover over the cam locks.
- 6.) Double Sided tape on bottom of side panels secures the riser to the desktop.