

RUSTLER Series Installation and Operation Guide Submersible Pumps

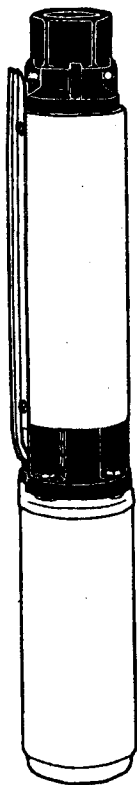

A	Pump Selection & Inspection	Page 3
B	Pre-Installation Preparation	Page 3
C	Electrical Preparation	Page 4
D	Installation of Pump in Well	Page 5
E	Above-Ground Electrical Connections	Page 6
F	Above-Ground Pipe & Tank Connections	Page 8
G	Controlling Weak Wells	Page 9
H	Trouble-Shooting	Page 9

Myers®

WARNING! IMPORTANT SAFETY INSTRUCTIONS! READ CAREFULLY BEFORE INSTALLATION



FAILURE TO FOLLOW THESE INSTRUCTIONS AND COMPLY WITH ALL CODES MAY CAUSE SERIOUS BODILY INJURY AND/OR PROPERTY DAMAGE.

△ 1) Before installing or servicing your pump, BE CERTAIN THE PUMP POWER SOURCE IS TURNED OFF AND DISCONNECTED.

△ 2) All installation and electrical wiring must adhere to state and local codes. Check with appropriate community agencies, or contact your local electrical and pump professionals for help.

△ 3) CALL AN ELECTRICIAN WHEN IN DOUBT. Pump must be connected to a separate electrical circuit directly from the entrance box. There must be an appropriately sized fuse or circuit breaker in this line. Tying into existing circuits may cause circuit overloading, blown fuses, tripped circuit breakers, or a burned up motor.

△ 4) Do not connect pump to a power supply until the pump is grounded. For maximum safety, a ground fault interrupter should be used. **CAUTION: FAILURE TO GROUND THIS UNIT PROPERLY MAY RESULT IN SEVERE ELECTRICAL SHOCK.**

△ 5) WARNING: Reduced risk of electric shock during operation of this pump requires the provision of acceptable grounding:

a) If the means of connection to the supply-connection box is other than grounded metal conduit, ground the pump back to the service by connecting a copper conductor, at least the size of the circuit conductors supplying the pump, to the grounding screw provided within the wiring compartment.

b) This pump is provided with a means for grounding. To reduce the risk of electric shock from contact with adjacent metal parts, bond supply box to the pump-motor-grounding means and to all metal parts accessible at the well head, including metal discharge pipes, metal well casing, and the like, by means of

(1) an equipment-grounding conductor at least the size of the well cable conductors, or the equivalent, that runs down the well with the well cable and,

(2) a clamp, a weld, or both if necessary, secured to the equipment-grounding lead, the equipment-grounding terminal, or the grounding conductor on the pump housing. The equipment-grounding lead, if one is provided, is the conductor that has an outer surface of insulation that is green with or without one or more yellow stripes.

△ 6) The voltage and phase of the power supply must match the voltage and phase of the pump.

△ 7) Do not use an extension cord; splices must be made with an approved splice kit and should be checked for integrity before submerging in water, above ground joints must be made in an approved junction box.

△ 8) Do not work on this pump or switch while the power is on.

△ 9) Never operate a pump with a frayed or brittle power cord, and always protect it from sharp objects, hot surfaces, oil and chemicals. Avoid kinking the cord.

△ 10) Never service a motor or power cord with wet hands or while standing in or near water or damp ground.

△ 11) The three phase units must be wired by a qualified electrician, using an approved starter box and switching device.

△ 12) Do not use this pump in or near a swimming pool, pond, lake or river.

△ 13) Single phase motors are either two wire units (two black power wires and a green ground), or three wire units (three power leads red, black, & yellow and a green ground). The three wire units require a control box. Make sure the control box matches the motor in voltage, horsepower, and phase.

△ 14) Single phase motors are equipped with automatic resetting thermal protectors. The motor may restart unexpectedly causing the leads to energize or pump to turn. Three phase motors should be protected by proper, thermal and amperage protection. (Check local codes.)

△ 15) Check for nicks in the wire and pump insulation by using an ohm meter and checking resistance to ground before installing the pump and after installing the pump. If in doubt on the proper procedure check with a qualified electrician.

△ 16) Do not pump gasoline, chemicals, corrosives, or flammable liquids; they could ignite, explode, or damage the pump, causing injury and voiding the warranty.



△ 17) Do not run this pump with the discharge completely closed. This will create superheated water, which could damage the seal, and shorten the life of the motor. This superheated water could also cause severe burns. Always use a pressure relief valve, set below the rating of the tank or system.

△ 18) Pump is capable of building pressures in excess of 100 PSI. Always use a pressure relief valve.

△ 19) The well, cistern, or pit must be sealed to prevent a child, animal or foreign object from falling in.

△ 20) While the well seal or cap is removed for repairs, cover the well to prevent foreign matter from entering, contaminating the well, and possibly damaging the pump.

△ 21) Test well water for potability; chlorinating the well or purifying, is recommended every time the well is opened. Check with local Health Departments for testing and sanitizing procedures.

CAUTION!

△ 22) The following may cause severe damage to the pump and void warranty. It could also result in personal injury:

- Running the pump dry.
- Failure to protect the pump from below freezing temperatures.
- Running the pump with the discharge completely closed.
- Pumping chemicals or corrosive liquids.

△ 23) Never work on the pump or system without relieving the internal pressure.

△ 24) Do not pump water above 120° Fahrenheit.

△ 25) Never exceed the pressure rating of any system component.

Read this guide completely before installation

Myers recommends a waterwell driller or experienced waterwell serviceman to install new water systems - or

to replace an existing submersible waterwell pump or pump motor. Please read this entire Guide before installing your Myers submersible pump. Tools needed: 2 pipe wrenches, pipe compound, screwdriver, measuring tape, propane torch, "Sta-Kan" crimping tool (or substitute), hammer, metal file, foot clamp.

CAUTION: Do not run unit dry. Unit can be severely damaged if run dry. For safe testing, wait until pump is wired, grounded and completely submerged.

A Pump Selection & Inspection

1. Select the right pump

Gallons per minute desired + pressure required + depth to pumping level determines which Myers Submersible Pump size and model is right for your waterwell system.

Some pumps are 3-wire models with the capacitor and relay located in the above-ground electrical motor control box. Others are 2-wire models. Motor control is not required on 2-wire models. Myers 3N Models are 3-wire; 2N Models are 2-wire.

2. Inspect your new pump & motor

After purchase, check the pump and other contents of the shipping container for possible damage. Do NOT lift the Myers Submersible Pump by its attached electric motor cables.

Find the loose owner's information-plates and check the listed model number against the label data on the outside shells covering the motor and the pump.

To make sure there is no hidden damage caused during shipment, we suggest checking for free rotation of the shaft prior to installation:

a) Remove the poppet retainer with a 1/2" hex socket wrench. Reach in

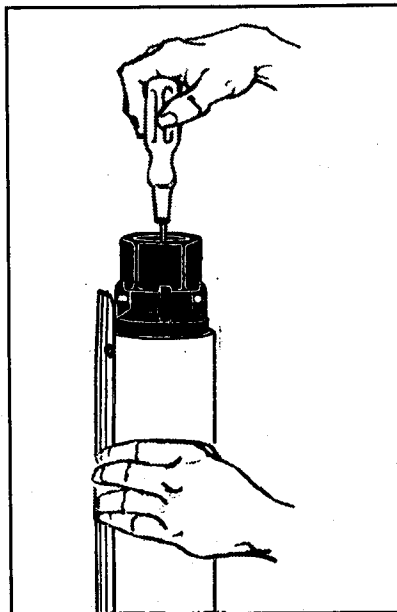

and lift out poppet. Then by inserting a screwdriver in the slot in the end of the now-visible shaft, check to see if the pump shaft turns freely; a slight drag is permissible.

b) replace the poppet and retainer.
c) again; do NOT run unit out of water.

3. Model Number Designation

2NFL52-12

Flow Rate:	5 = 5 GPM
	8 = 8 GPM
	12 = 12 GPM
	20 = 20 GPM
	25 = 25 GPM
Voltage:	1 = 115V
	2 = 230V
HP:	5 = 1/2 HP
	7 = 3/4 HP
	10 = 1 HP
	15 = 1-1/2 HP
	20 = 2 HP
Model Designation:	NFL = Rustler & Franklin Motor
Number Wires:	2 = 2 wire & ground
	3 = 3 wire & ground

B Pre-Installation Preparation

1. New Wells

a) **Location of pump.** Your Myers Submersible Pump can be installed at nearly any well location for years and years of dependable, trouble-free service. For new wells, always locate well to provide for easy removal and replacement of pump. The water tank and electrical controls can, of course, be located some distance from the well.

b) **Determine depth of pump in well** in order to purchase electrical cables of sufficient gauge and length to reach from pump motor to electrical motor

control box - and to purchase galvanized iron pipe, PVC rigid plastic pipe or flexible plastic pipe of sufficient length to reach from pump discharge to water tank. (See cable-length and cable-size charts in Sections C2 and C3.)

c) **Location of water tank & electrical controls.** Always install the pressure tank and electrical controls in a clean, dry basement or utility room to avoid dampness and temperature extremes. In any installation where the pump pressure could exceed the storage tank pressure, provide a pressure relief valve piped to a suitable drain.

2. Replacing pump (or motor only) in existing well

a) **Turn off power** at electrical control box.

b) **Remove well seal** from top of well.
c) **Remove old pump** from well:

1) if galvanized iron or rigid plastic PVC pipe was used originally, you'll find a number of rigid sections joined together. Pull pipe upward and dismantle each section as you go, untaping or unbanding electrical motor

cables from each section until you reach pump.

2) if flexible plastic pipe was used originally, pull pipe upward - coiling pipe and cables in a big circle as you go - until you reach the pump.

3) when old pump is out of well,

cut electrical cables as close to original splice connection as possible.

4) while new cable is preferred (because it will remain submerged for a number of years), you may wish to re-use the old cable. Wipe off and clean the insulation, examining care-

fully for cuts, cracks and abrasions. If in doubt, purchase new cable.

5) if new cable is necessary, measure length of old cable (from pump motor to electrical control box) and purchase sufficient replacement lengths.

Electrical Preparation

1. Motor voltage

Myers Submersible Pumps operate on 115-volts or on 230-volts, single phase current.

a) The motor is NOT dual voltage; therefore, select the pump for one or the other: 115-volt or 230-volt.

b) If available, 230-volt installation is recommended. (Electrical power service today provides both 115-volt and 230-volt.)

Motor control box must be same horsepower size and voltage as motor. (Used only with 3-wire motors).

*For Minimum Entrance Box Service Rating see chart below.

2. Cable size

Submersible pump cable is not just ordinary wire; the copper cable is well insulated with and stands many years of complete submersion in water. Selection of proper size cable is very important. Under-sized cable results in too low a voltage supply to the motor and ultimate motor failure. Over-sized cable will cost much more than proper-sized cable. See chart of proper-sized cable (in chart, the smaller the AWG number, the larger the cable wire size).

For TWU, installation: a) type RWU, TWU, SGOW or SWOW supply cables are recommended. b) The well seal and motor case shall be bonded to the main A-C ground.

NOTE: Ground wire size should be equal to connector size.

Franklin 4 Inch Motor Minimum Service Requirements

HP	Volts	Wire	Min. Service
1/2	115	2W	200 amp
1/2	115	3W	200 amp
1/2	230	2W	60 amp
1/2	230	3W	60 amp
3/4	230	2W	100 amp
3/4	230	3W	100 amp
1	230	2W	100 amp
1	230	3W	100 amp
1-1/2	230	2W	200 amp
1-1/2	230	3W	200 amp
2	230	3W	200 amp

3. Length of cable

Maximum cable length specified for each horsepower size and minimum AWG cable wire size referred to in chart means the total distance from the submerged pump motor to the electrical motor control box as shown in this diagram.

Myers warranty is void if under-sized AWG cable is used or if cable lengths longer than specified for each cable wire size are used.

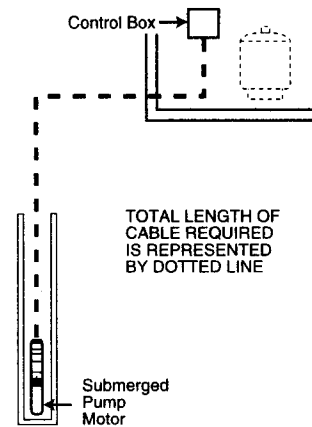

MAXIMUM CABLE LENGTH IN FEET

HP	Wire	Volts	Phase	Max. Amps	Maximum Cable Length Using AWG Cable Size							
					#14	#12	#10	#8	#6	#4	#2	#0
1/2	2	115	1	12.0	100	160	250	390	620	960	1460	2160
	2	230	1	6.0	400	650	1020	1610	2510	3880	5880	8720
	3	115	1	12.0	100	160	250	390	620	960	1460	2160
	3	230	1	6.0	400	650	1020	1610	2510	3880	5880	8720
3/4	2	230	1	8.0	300	480	760	1200	1870	2890	4370	6470
	2	230	1	8.0	300	480	760	1200	1870	2890	4370	6470
1	2	230	1	9.8	250	400	630	990	1540	2380	3610	5360
	3	230	1	9.8	250	400	630	990	1540	2380	3610	5360
1-1/2	2	230	1	13.1	190	310	480	770	1200	1870	2850	4280
	3	230	1	11.5	190	310	480	770	1200	1870	2850	4280
2	3	230	1	13.2	150	250	390	620	970	1530	2360	3620

4. Splicing power cables to pump

After making sure your power cables are the proper AWG size and specified length, splice them to the pump cables (see illustrations):

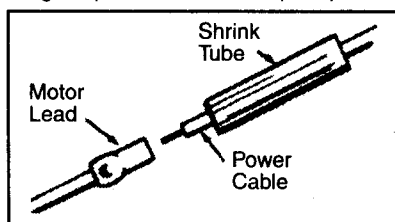

a) Slip shrink tube over end of each power cable.

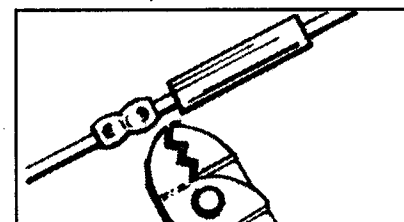

b) Match pump cables to power cables and crimp connectors on each pair.

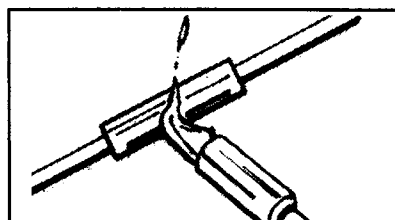

c) Slide shrink tubes over center of crimped connectors and apply heat (from propane torch) from center to both ends of shrink tubes.

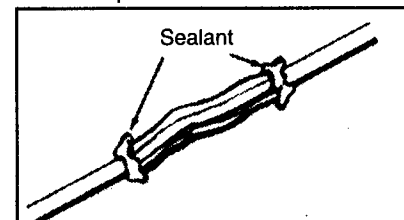

d) Splice is complete when sealant flows from ends of shrink tubes.

NOTE: Splice kits are not included with pumps.

5. Motor grounding instructions

WARNING: Reduced risk of electric shock during operation of this pump requires the provision of acceptable grounding:

This pump is provided with a means for grounding. To reduce the risk of electric shock from contact with adjacent metal parts, bond supply box to the pump-motor-grounding means and to all metal parts accessible at the well head, including metal discharge pipes, metal well casing, and the like, by means of (1) an equipment-grounding conductor at least the size of the well cable conductors, or the equivalent, that runs down the well with the well cable and (2) a clamp, a weld, or both if necessary, secured to the equipment-grounding lead, the equipment-grounding terminal, or the grounding conductor on the pump

housing. The equipment-grounding lead, if one is provided, is the conductor that has an outer surface of insulation that is green with or without one or more yellow stripes. NOTE: N.E.C. requires submersible pumps be grounded at installation.

WARNING: Failure to ground this unit properly may result in severe electrical shock.

Grounding your new submersible motor is accomplished by running a copper grounding wire from the green pigtail lead to the main electrical system ground. Following is the recommended grounding procedure:

a) The grounding wire to be used must be the same size as the power conductor wires. Insulated stranded or insulated solid copper wire may be used. Aluminum wire is NOT suitable for this application.

Caution: Do not put the ground wire into a bind.

b) Connect the top end of the ground wire to the main electrical system ground on the control box on a 3-wire system or the pressure switch on a 2-wire system, if they are grounded to the main electrical system ground.

Motor Electrical Test Data

No. Wires	HP	V	Ph	Ohms Resistance	
				Yellow to Black	Yellow to Red
1Ø 3 Wire Motors					
3	1/2	115	1	1.0 - 1.3	4.1 - 5.1
3	1/2	230	1	4.2 - 5.2	16.7 - 20.5
3	3/4	230	1	3.0 - 3.6	11.0 - 13.4
3	1	230	1	2.2 - 2.8	9.5 - 11.7
3	1-1/2	230	1	1.5 - 2.3	6.2 - 12.0
3	2	230	1	1.6 - 2.3	5.2 - 7.2
1Ø 2 Wire Motors					
				Black to Black	
2	1/2	115	1	1.0 - 1.3	
2	1/2	230	1	4.2 - 5.2	
2	3/4	230	1	3.0 - 3.6	
3	1	230	1	2.2 - 2.7	
2	1-1/2	230	1	1.5 - 1.9	

D Installation of Pump in Well

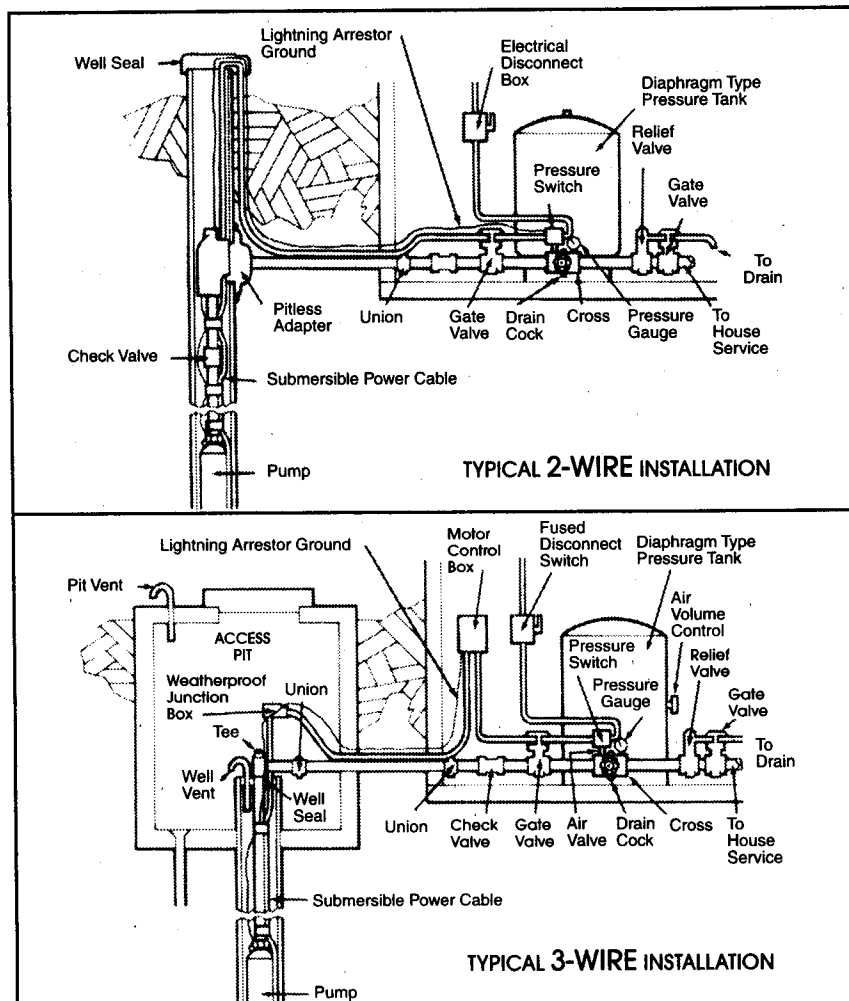

CAUTION: Do NOT use pipe wrench on ANY part of pump except hex connection at top of discharge end or check valve.



Do NOT use pipe compound at discharge!

USE PIPE WRENCH HERE ONLY



DO NOT USE PIPE WRENCH ON SHELL

1. Before lowering pump

a) Smooth out any rough spots or sharp edges on the top lip of the well casing with a hammer or metal file to prevent damage to the pump or power cables, when lowering into well.

b) Safety cable. To aid in lowering pump when plastic PVC or flexible plastic pipe is to be used or to aid in raising the pump for future maintenance - attach nylon or stainless steel cable to lifting eye of pump.

c) The starting torque of the pump motor tends to give a twist which could cause the pump shell to rub against the inside walls of the well casing - especially if rigid PVC or flexible plastic pipe is used. To dampen this twisting, we suggest torque stops be used in all installations.

d) Attach a brass or steel adapter to top end of the pump and tightly band PVC or flexible plastic pipe to the adapter for a tough, long-lasting fit.

e) As you add additional sections of galvanized iron pipe or rigid plastic PVC pipe, apply pipe compound only to the male threaded ends of each section and tighten to next section.

f) For flexible plastic pipe installations we recommend 160-lb. pipe for a lasting trouble-free installation.

g) Tape the power cables and safety lifting cable to the pipe, straight up from bottom to top. Do NOT spiral cable around the pipe. Use waterproof tape or nylon lock bands every 5-ft. on flexible plastic pipe or every 10-ft. on PVC plastic or galvanized iron pipe. Do not allow any excess cable

between bands; cable must be as flat against pipe as possible.

2. Lowering the pump

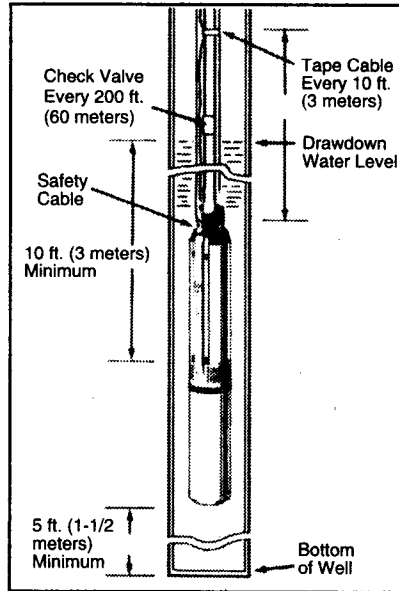

a) Align pump carefully when beginning to lower it down the well casing. Do not let the pump, cables or pipe rub against the well casing. Take care that cable insulation is not dragged or scraped over the top lip of the well casing.

b) Depth of pump setting. Lower pump into well without forcing. Use foot clamp to hold galvanized iron or plastic PVC pipe while connecting

the next length of pipe and taping the power cables.

(On **deep** settings, we recommend that a check valve be installed in the pipe 200-ft. above the pump and every 200-ft. thereafter to prevent water shock from traveling back to pump.)

Lower pump to at least 10-ft. below the maximum drawdown of the water level, if possible, and never closer than 5-ft. from the bottom of the well.

c) Pipe fitting to support pump. When a well seal is used, either a coupling, elbow, or tee is installed on the

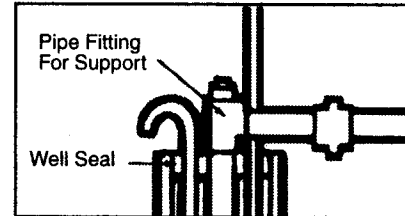

top end of the last vertical length of pipe and is allowed to rest on the outside of the well seal to support the pipe, power cables, safety cable and pump. Most well seals provide a fitting to seal the power cables; but if no such fitting is provided, conduit must be used to protect cables and to prevent water and any foreign matter from leaking into well around cable.

d) Frost-proof pitless installation. In installations where the pipe from the well seal to the water tank is subject to frost or freezing conditions, a pitless installation is recommended. (See diagram on page 5.)

E Above-Ground Electrical Connections

Franklin Control Box

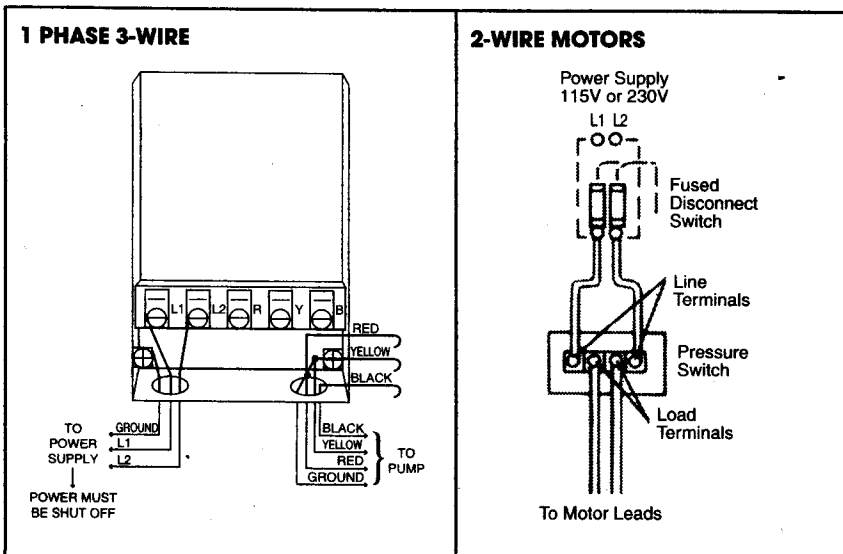

Franklin Control Box

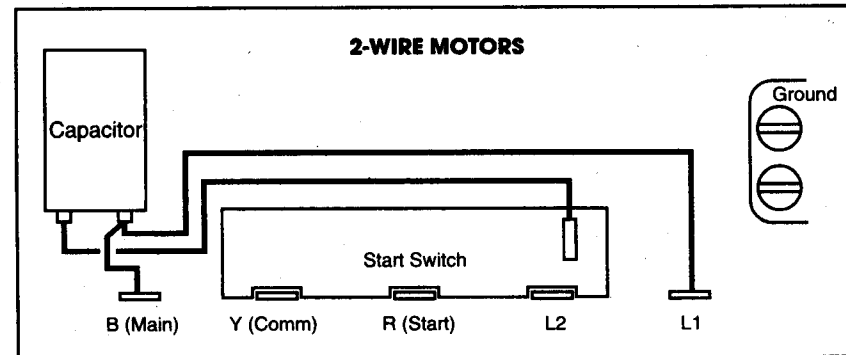
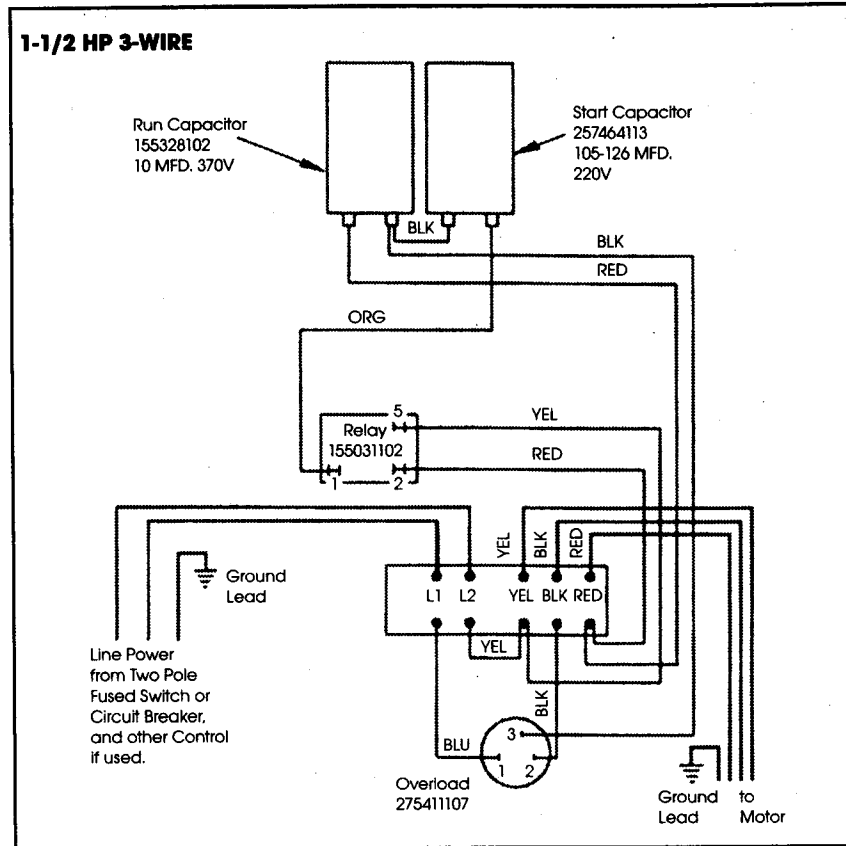

1. Connect pressure switch & power cables

Single Phase

a) Run two power lines (see diagram) directly from the fused disconnect switch and connect to the line terminals of the pressure switch. Then:

For 3-wire pumps, run two power lines from the load terminals of the pressure switch and connect to L1 and L2 of the motor control box. Then, connect the 3 colored wires of the pump cable to the matching black, red and yellow terminals of the motor control box.

For 2-wire pumps, connect pump cables directly to load terminals of

the pressure switch (color matching is not necessary).

b) Same connections are used for either 115-volt or 230-volt pumps. Motors are automatically protected against overload damage by built-in thermal control element.

c) Be sure to attach owner-information plates, furnished with the pump, to the lid of the motor control box for 3-wire models; or to fused disconnect switch for 2-wire models. This is the only above-ground record of the pump size and electrical data.

Single Phase Fuse Chart

HP	VOLTS	WIRE	TIME DELAY PLUG OR DUAL ELEMENT PLUG OR CART. FUSE	STANDARD PLUG OR CART. LINE FUSE
1/2	115	2	17-1/2	25
1/2	230	2	8	10
3/4	230	2	10	25
1	230	2	12	25
1/2	115	3	20	40
1/2	230	3	9	20
3/4	230	3	12	30
1	230	3	15	30

2. Fuses for disconnect switch

Power supply is wired directly from the main supply to a separate fused disconnect switch.

For 115-volt current, use a single-pole switch; it is necessary to break and fuse only the hot line.

For 230-volt, single phase current, (recommended for all new single phase installations), a 2-pole switch should always be used so that both lines are broken and fused.

3. Lightning Arrestor

A lightning arrestor is strongly recommended on every installation. Arrestor must be installed inside the motor control box or fused disconnect (see diagram).

The best possible ground for lightning arrestor is the system ground. For safety, close the motor control box cover before turning on power.

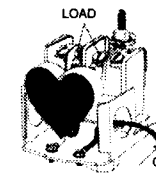

Single Phase (Heart) in Pressure Switch

1. Connect one black lead to each load terminal.
2. Attach the white lead to pressure switch ground screw.
3. Ground the pressure switch by running a #10 or larger wire to the submersible pump.

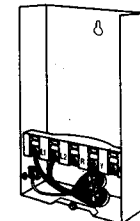

Single Phase (Heart) In Control Box or Fused Disconnect Box

1. Connect one black lead to terminal marked L1 and the other black lead to terminal marked L2 in control box.
2. Attach the white lead to green grounding connection on side of control box.
3. Any grounding wire should be a #10 or larger wire and be connected to the submersible pump and a ground connection in control box.

F Above-Ground Pipe & Tank Connections

NOTE: Whenever the pump pressure can exceed the pressure rating of the tank, a relief valve must be installed and piped to a suitable drain.

1. Check pump before connecting piping to tank

With all electrical connections complete and pump now lowered to desired depth, install a gate valve in the discharge pipe near well for preliminary test run (see diagram). Turn on power. Gradually open gate valve and let pump run until water is clear of sand and other impurities.

Fully open gate valve. If pump lowers water in the well to a point at which the pump loses its prime, either:

- Lower pump further down well (if possible); or,
- "Throttle" the pump to the capacity of the well by using a flow valve (see Section G).

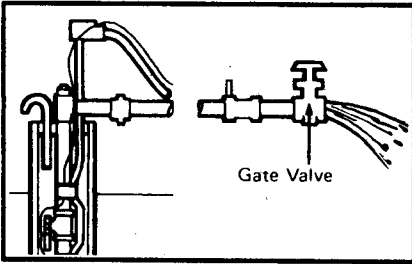

2. Connecting diaphragm tank system

a) Connect all piping as shown in diagram.

b) Precharge tank to specified pressure (see instructions furnished with tank). If the system is to be set to operate at 30/50 pressure settings, the tank should be precharged to 28 psi (or 18 psi if system pressure is to be 20/40). Tank precharge pressure should always be 2 psi below the "cut-in" of the pressure switch.

c) Start pump. Pressure in tank will build up to cut-off pressure of pressure switch setting.

d) The system should now operate automatically.

3. Connecting standard galvanized tank system

a) Connect all piping as shown in diagram.

b) Start pump. Pressure in tank will build up to cut-off pressure of switch setting.

c) The system should now operate automatically.

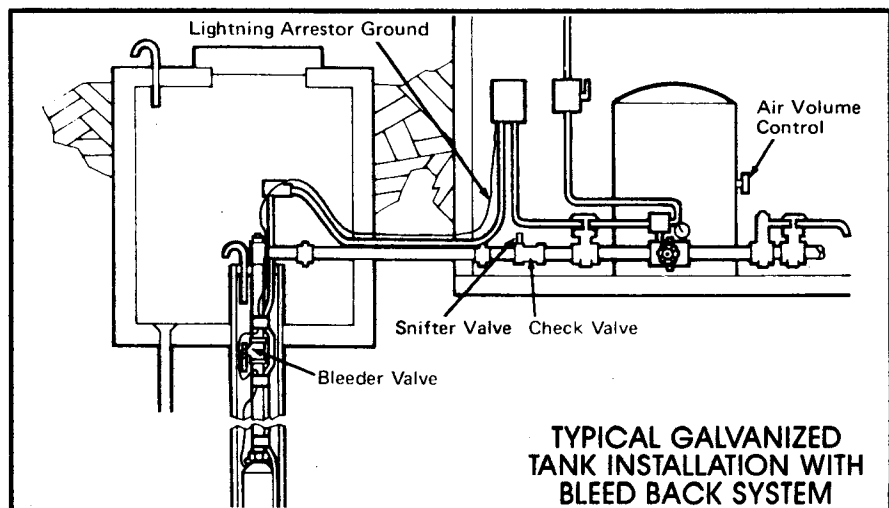
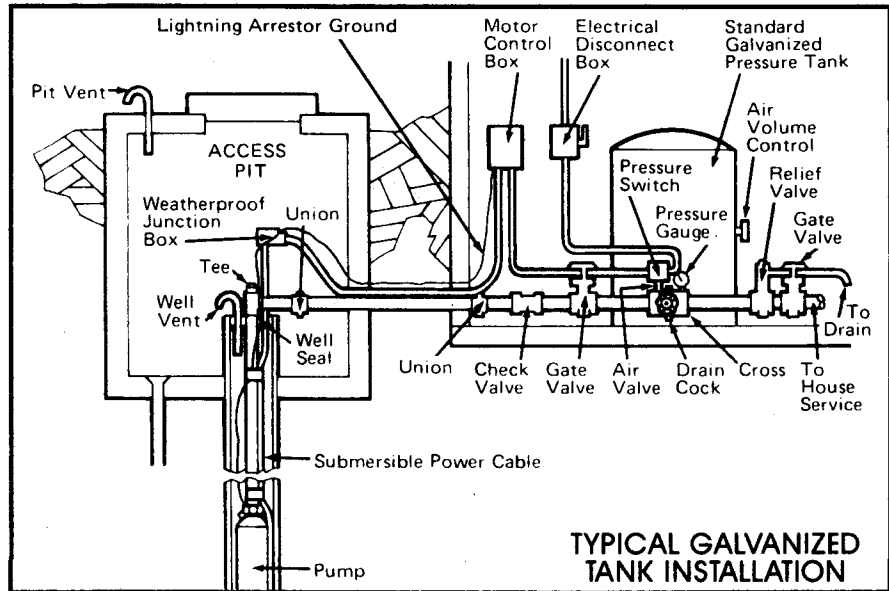
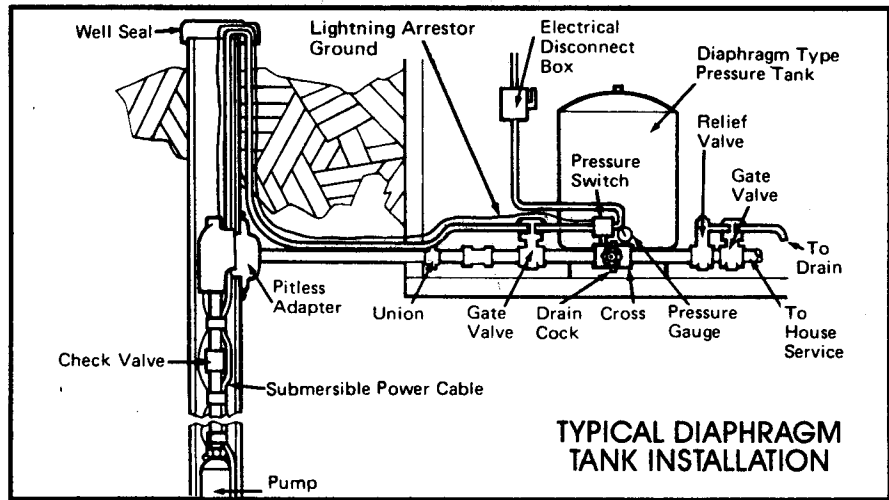

4. Connecting bleed-back valve system

Distance from bleeder to sniffer valve	Tank size
5-ft	42 gallons
7-ft	82 gallons
9-ft	120 gallons
12-ft	220 gallons
15-ft	315 gallons

a) Install the bleeder orifice 5-ft or more below sniffer valve. Check and sniffer valves can be installed inside the well casing under the well seal or

outside the casing just ahead of the pressure tank. Refer to installation diagram on page 7 and the table at left for recommended distances on various tank sizes.

b) Connect all piping as shown in diagram.

c) Start pump. Pressure in tank will build up to cut-off pressure of switch setting.

d) After pump has cut-out, open faucet and drain tank pressure to cut-in point of pressure switch.

e) Run the automatic cycle several times and check the air-charging cycle. Each time the pump stops, the surface check valve closes and water starts to

drain back through the bleeder valve. This causes a vacuum in the discharge pipe and air is drawn in through the sniffer valve installed in the check valve. Water will drain down to the bleeder valve, filling the pipe between the check valve and bleeder valve with air. When the pump re-starts, this air will be forced ahead of the water into the pressure tank. This method always supplies excess air which is vented off by the automatic air volume control.

f) To check proper operation, a vacuum should be felt at the sniffer valve when pump stops. (See illustration for position of bleeder valve, check valve and sniffer valve.)

G Controlling Weak Wells

The flow valve method is the simplest way to prevent drawdown to pump inlet. The capacity of the pump discharge is throttled to equal the well yield. A Dole Flow Valve delivers a constant capacity regardless of pump discharge pressure. The flow valve is installed in the discharge line between the pump and the pressure tank. The usual way to determine what size of

flow valve to use is to throttle the discharge gate valve to a capacity that the well will yield without drawing down. After pump has operated at this capacity for a sufficient time to be sure it is suitable, measure the flow in gallons-per-minute and select a flow valve size nearest to this capacity. Install the flow valve and re-check to be sure operation is satisfactory.

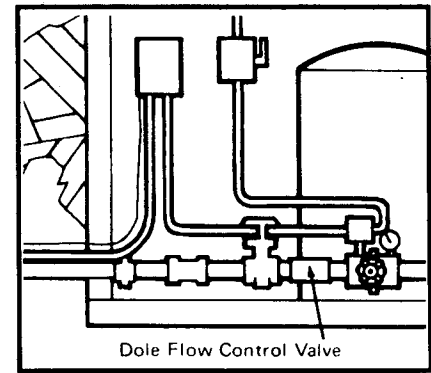

H Trouble-Shooting

The vast majority of service calls on waterwell systems are caused by either water logged tanks or by problems which are electrical in nature.

The Myers Submersible Pump and waterwell system should be checked periodically for quality of water, draw-down, pressure, GPM, cycling periods

(how often the pump starts and how long it runs) and proper operation of all automatic controls.

Never operate the pump for long periods of time with the discharge valve closed. This could cause overheating resulting in damage to the pump and its motor. A properly-sized

relief valve should be installed before the tank to prevent the pump from operating with the discharge valve closed.

Familiarize yourself with potential problems and trouble-shooting solutions.

PROBLEM

Pump won't run

PROBABLE CAUSE

Blown fuse, broken (or loose) electrical connections.

Pressure switch not closing.

Motor overload protection contacts open.

Incorrect control box.

Improper wiring connections.

Low voltage.

SOLUTION

Check fuses, capacitor, relays and all electrical connections.

Adjust or replace.

Contacts will close automatically within short time.

Check & replace if necessary.

Check wiring diagram.

Check voltage at control box.

PROBLEM**PROBABLE CAUSE****SOLUTION**

Pump runs, but no water pumped

Check valve installed backwards.

Reverse and re-install.

Setting too deep for rating of pump.

Check rating table.

Pump not submerged; not deep enough in well.

Lower pump if possible. Check recovery of well.

Pump in mud, impeller plugged or intake strainer clogged.

Pull pump and clean. Check well depth. Raise pump if necessary.

Reduced capacity

Strainer or impellers partially clogged or plugged.

Pull pump and clean.

Corroded discharge pipe.

Replace pipe.

Pressure switch won't cut out

Pressure switch not set correctly.

Revise settings: 20-lb cut-in, 40-lb cut-out; or 30/50 (depending on tank size).

Water level too low in well for rating of pump.

Check pump setting.

Switch opening clogged.

Clean out openings or, if necessary replace switch.

Pump starts too often, runs too long

Water-logged tank (loss of air pressure).

Check tanks for leaks. Re-charge with air pressure to proper level. Check air volume control.

Check valve leaks.

Replace or repair.

Pressure switch out of adjustment.

Adjust to proper setting and check to assure setting remains. If not, replace pressure switch.

Leaks in pipe.

Check above-ground piping for leaks. If none, pull pump and check all pipe connections and connection of pipe to pump.

Any or all the above

All known causes are checked but system won't work properly.

Call your Myers dealer, your waterwell driller or your waterwell serviceman.

For your reference

Fill in the following information and keep this Installation & Operation Guide among your important papers. Information about your Myers Submersible Pump will be found on the owner's information-plate. Whenever necessary to contact your dealer or installer, give him this information.

Motor Model No. _____ Pump Model No. _____

HP _____ Phase _____ Volts _____ Cycles _____

Amps: L1 _____ L2 _____ Date of Installation _____

Well depth _____ ft. Pump depth _____ ft.

Name of dealer installer from whom pump was bought _____

_____ Date of purchase _____

all rights reserved

MYERS LIMITED WARRANTY WATER SYSTEMS

During the time periods and subject to the conditions hereinafter set forth, F.E. Myers will repair or replace to the original user or consumer any portion of your new Myers product which proves defective due to defective materials or workmanship of Myers. Contact your nearest authorized Myers dealer for warranty service. At all times Myers shall have and possess the sole right and option to determine whether to repair or replace defective equipment, parts or components. Damage due to lightning or conditions beyond the control of Myers are NOT COVERED BY THIS WARRANTY.

WARRANTY PERIOD

Submersible and Jet Pumps: 12 months from the date of installation or 18 months from the date of manufacture, whichever occurs first.

Galvanized Tanks: 12 months from date of installation or 18 months from date of manufacture, whichever occurs first.

Diaphragm Tanks: 5 years from date of installation.

LABOR, COSTS: Myers shall IN NO EVENT be responsible or liable for the cost of field labor or other charges incurred by any customer in removing and/or reaffixing any Myers product, part or component thereof.

THIS WARRANTY WILL NOT APPLY: (a) to defects or malfunctions resulting from failure to properly install, operate or maintain the unit in accordance with printed instructions provided; (b) to failures resulting from abuse, accident, or negligence; (c) to normal maintenance services and the parts used in connection with such service; (d) to units which are not installed in accordance with applicable codes, ordinances and good trade practices; or (e) to unit used for purposes other than for what it was designed and manufactured, and (f) if three phase submersible motors are installed on a single phase power supply using a phase converter or if three phase power is supplied by only two transformers, making an open Delta system.

RETURN OR REPLACED COMPONENTS: any item to be replaced under this Warranty must be returned to Myers at Ashland, Ohio, or such place as Myers may designate, freight prepaid.

PRODUCT IMPROVEMENTS: Myers reserves the right to change or improve its products or any portions thereof without being obligated to provide such a change or improvement for units sold and/or shipped prior to such change or improvement.

WARRANTY EXCLUSIONS: as to any specific Myers product, after the expiration of the time period of the warranty applicable thereto as set forth above. THERE WILL BE NO WARRANTIES, INCLUDING ANY IMPLIED WARRANTIES OF MERCHANTABILITY OR FITNESS FOR ANY PARTICULAR PURPOSE.

Some states do not allow limitations on how long an implied warranty lasts, so the above limitation may not apply to you. No warranties or representations at any time made by any representative of Myers shall vary or expand the provisions hereof.

LIABILITY LIMITATION: IN NO EVENT SHALL MYERS BE LIABLE OR RESPONSIBLE FOR CONSEQUENTIAL, INCIDENTAL OR SPECIAL DAMAGES RESULTING FROM OR RELATED IN ANY MANNER TO ANY MYERS PRODUCT OR PARTS THEREOF.

Some states do not allow the exclusion or limitation of incidental or consequential damages, so the above limitation or exclusion may not apply to you.

This Warranty gives you specific legal rights and you may also have other rights which vary from state to state. In the absence of other suitable proof of this installation date, the effective date of this warranty will be based upon the date of manufacture plus one year. Direct All Notices To: Warranty and Product Service Department, F.E. Myers, 1101 Myers Parkway, Ashland, Ohio 44805-1969.

DETERMINATION OF UNIT DATE OF MANUFACTURE: Examples are: *Submersible* - 7-29-84, Month - Day - Year on motor nameplate and pump nameplate; *Sump, Centrifugal & Ejecto Pumps* - 8-84, Month - Year stamped on pump nameplate; **MYERS Diaphragm Tanks** - A85188581, 1st letter month A=85 - tanks are postdated by 3 months on label; *Galvanized* - 3-0921, Year - Month - Day 1983-9-21 stamped on edge of head.

Myers®

F.E. Myers, 1101 Myers Parkway, Ashland, Ohio 44805-1969
419/289-1144, FAX: 419/289-6658
www.industry.net/fe.myers

ATTENTION!
IMPORTANT INFORMATION FOR INSTALLERS OF THIS EQUIPMENT!

THIS EQUIPMENT IS INTENDED FOR INSTALLATION BY TECHNICALLY QUALIFIED PERSONNEL. FAILURE TO INSTALL IT IN COMPLIANCE WITH NATIONAL AND LOCAL ELECTRICAL CODES, AND WITH FRANKLIN ELECTRIC RECOMMENDATIONS, MAY RESULT IN ELECTRICAL SHOCK OR FIRE HAZARD, UNSATISFACTORY PERFORMANCE, AND EQUIPMENT FAILURE. FRANKLIN INSTALLATION INFORMATION IS AVAILABLE FROM PUMP MANUFACTURERS AND DISTRIBUTORS, AND DIRECTLY FROM FRANKLIN ELECTRIC. CALL FRANKLIN TOLL FREE 800-348-2420 FOR INFORMATION. RETAIN THIS INFORMATION SHEET WITH THE EQUIPMENT FOR FUTURE REFERENCE.

WARNING!

SERIOUS OR FATAL ELECTRICAL SHOCK MAY RESULT FROM FAILURE TO CONNECT THE MOTOR, CONTROL ENCLOSURES, METAL PLUMBING, AND ALL OTHER METAL NEAR THE MOTOR OR CABLE, TO THE POWER SUPPLY GROUND TERMINAL USING WIRE NO SMALLER THAN MOTOR CABLE WIRES. TO REDUCE RISK OF ELECTRICAL SHOCK, DISCONNECT POWER BEFORE WORKING ON OR AROUND THE WATER SYSTEM. DO NOT USE MOTOR IN SWIMMING AREAS.

ATTENTION!
INFORMATIONS IMPORTANTES POUR L'INSTALLATEUR DE CET EQUIPMENT!

CET EQUIPEMENT DOIT ETRE INSTALLE PAR UN TECHNICIEN QUALIFIE. SI L'INSTALLATION N'EST PAS CONFORME AUX LOIS NATIONALES OU LOCALES AINSI QU'AUX RECOMMANDATIONS DE FRANKLIN ELECTRIC, UN CHOC ELECTRIQUE, LE FEU, UNE PERFORMANCE NON ACCEPTABLE, VOIRE MEME LE NON-FONCTIONNEMENT PEUVENT SURVENIR. UN GUIDE D'INSTALLATION DE FRANKLIN ELECTRIC EST DISPONIBLE CHEZ LES MANUFACTURIERS DE POMPES, LES DISTRIBUTEURS, OU DIRECTEMENT CHEZ FRANKLIN. POUR DE PLUS AMPLES RENSEIGNEMENTS, APPELEZ SANS FRAIS LE 1-800-348-2420. CONSERVEZ CETTE FEUILLE D'INFORMATION AVEC L'EQUIPEMENT POUR CONSULTATION FUTURE.

AVERTISSEMENT!

UN CHOC ELECTRIQUE SERIEUX OU MEME MORTEL EST POSSIBLE, SI L'ON NEGLIGE DE CONNECTER LE MOTEUR, LA PLOMBERIE METALLIQUE, BOITES DE CONTROLE ET TOUT METAL PROCHE DU MOTEUR A UN CABLE ALLANT VERS UNE ALIMENTATION D'ENERGIE AVEC BORNE DE MISE A LA TERRE UTILISANT AU MOINS LE MEME CALIBRE QUE LES FILS DU MOTEUR. POUR REDUIRE LE RISQUE DE CHOC ELECTRIQUE. COUPER LE COURANT AVANT DE TRAVAILLER PRES OU SUR LE SYSTEM D'EAU. NE PAS UTILISER CE MOTEUR DANS UNE ZONE DE BAIGNADE.

ATENCION!
INFORMACION PARA EL INSTALADOR DE ESTE EQUIPO!

PARA LA INSTALACION DE ESTE EQUIPO, SE REQUIERE DE PERSONAL TECNICO CALIFICADO. EL NO CUMPLIR CON LAS NORMAS ELECTRICAS NACIONALES Y LOCALES, ASI COMO CON LAS RECOMENDACIONES DE FRANKLIN ELECTRIC DURANTE SU INSTALACION, PUEDE OCASIONAR: UN CHOQUE ELECTRICO, PELIGRO DE UN INCENDIO, OPERACION DEFECTUOSA E INCLUSO LA DESCOMPOSTURA DEL EQUIPO. LOS MANUALES DE INSTALACION Y PUESTA EN MARCHA DE LOS EQUIPOS, ESTAN DISPONIBLES CON LOS DISTRIBUIDORES, FABRICANTES DE BOMBAS O DIRECTAMENTE CON FRANKLIN ELECTRIC. PUEDE LLAMAR GRATUITAMENTE PARA MAYOR INFORMACION AL TELEFONO 800-348-2420. GUARDAR ESTA INFORMACION JUNTO AL EQUIPO PARA FUTURAS CONSULTAS.

ADVERTENCIA!

PUEDE OCURRIR UN CHOQUE ELECTRICO, SERIO O FATAL DEBIDO A UNA ERRONEA CONECCION DEL; MOTOR, DE LOS TABLEROS ELECTRICOS, DE LA TUBERIA, DE CUALQUIER OTRA PARTE METALICA QUE ESTA CERCA DEL MOTOR POR NO UTILIZAR UN CABLE PARA TIERRA DE CALIBRE IGUAL O MAYOR AL DE LA ALIMENTACION. PARA REDUCIER EL RIESGO DE CHOQUE ELECTRICO. DESCONECTAR LA ALIMENTACION ELECTRICA ANTES DE INICIAR A TRABAJAR EN EL SISTEMA HIDRAULICO. NO UTILIZAR ESTE MOTOR EN ALBERCAS O AREAS EN DONDE SE PRACTIQUE NATACION.



Franklin Electric
Blufton, Indiana 46714