



Construction

Close-coupled peripheral pumps (regenerative pumps) with turbine impeller.

Connections: threaded ports NPT.

Applications

For clean liquids without abrasives, without suspended solids, non-explosive, non-aggressive for the pump materials. For increasing network pressure (follow local specifications). For the reduced dimensions, these pumps are very well suitable to be mounted in cooling and air-conditioning machines and equipments, circulation, boiler feed.

Operating conditions

Liquid temperature from 14 °F (-10 °C) to 194 °F (+90 °C).
Ambient temperature up to 104 °F (40 °C).
Total suction lift up to 23 ft (7 m).
Continuous duty.

Motor

2-pole induction motor, 60 Hz (n = 3450 rpm).
Three-phase 230/460 V.
Single-phase 115 V, 230 V, with thermal protector.
Capacitor inside the terminal box.

Insulation class F.
Protection IP 44.

Special features on request

- Other voltages.
- Special mechanical seal
- Higher or lower liquid or ambient temperatures.

Materiales

Components	CT, T, TP
Pump casing	Cast iron GJL 200 EN 1561
Lantern bracket	Cast iron GJL 200 EN 1561
Casin cover	Brass CW510L (lead free public LAW 111-380) Cast iron GJL 200 EN 1561 for T 76, TP 80
Impeller	Brass CW510L (lead free public LAW 111-380)
Shaft	Chrome-nickel steel AISI 303 for T 76, TP 80 Chrome steel AISI 430 for CT, T 61-65-70
Mechanical seal	Carbon - Ceramic - NBR

Performance range n = 3450 rpm

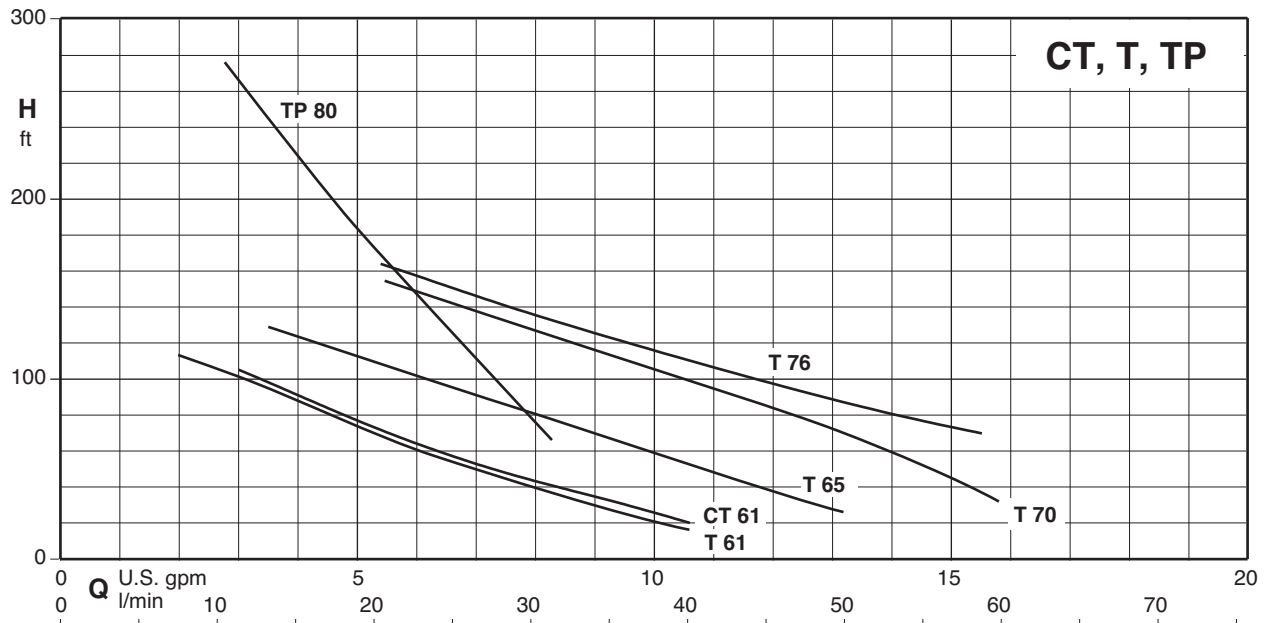

Performance n = 3450 rpm

230/460 V 3~	115 V 1~	230 V 1~	P ₂ HP	H ft	15	25	35	55	75	95	110	115	130	135	155	164	
CT61 03H36S	CT61 03A16S	CT61 03C16S	0,33	Q US gpm	11,3	10	8,8	6,9	5,2	3,7	3						
T61 03H36S	T61 03A16S	T61 03C16S	0,33		10,7	9,5	8,4	6,5	5	3,5	2,3	2					
T65 05H36S	T65 05A16S	T65 05C16S	0,5			13,3	12,3	10,4	8,5	6,5	5,2	4,8	3,5				
T70 07H36S	T70 07A16S	T70 07C16S	0,5					15,6	14	12,4	10,7	9,4	9				
T70H 05H36S	T70H 05A16S	T70H 05C16S	0,75					15,7	14,3	12,8	11	9,7	9	8	7	5,4	
T76 10H36S	T76 10A16S	T76 10C16S	1							14,9	12,4	10,7	10,2	8,6	8	6	5,3

230/460 V 3~	115 V 1~	230 V 1~	P ₂ HP	H ft	65	85	105	125	145	165	185	205	225	245	265
TP80 07H36S	TP80 07A16S	TP80 07C16S	0,75	Q US gpm	8,3	7,7	7,1	6,6	6	5,5	5	4,4	3,9	3,4	3

P₂ Rated motor power output.

Tolerances according to UNI EN ISO 9906:2012

H Total head in ft.

* Maximum suction lift 6.5-10 ft.

Dimensions and weights

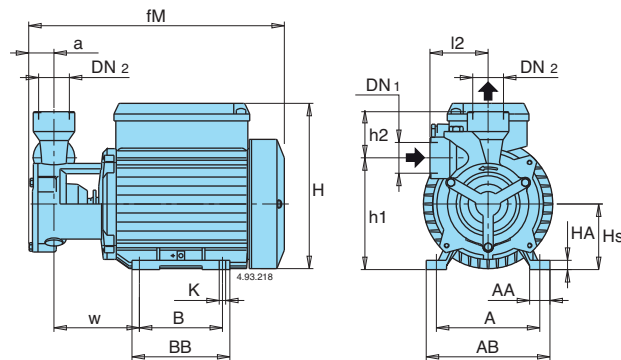

TYPE	DN ₁	DN ₂	in																lb
			NPT		a	fM	H _s	h ₂	h ₁	H	BB	B	AB	A	AA	K	I ₂	w	
CT 61	1	1	0.87	7.8	2.48	1.77	4.25	6.3	3.78	3.15	4.8	3.94	0.87	0.28	2.28	1.59	0.31	10,12	
T 61	1	1	0.94	9.61	2.48	2.56	4.25	6.3	3.78	3.15	4.8	3.94	0.87	0.28	2.28	3.15	0.31	12,32	
T 65	1	1	0.94	9.61	2.48	2.56	4.25	6.3	3.78	3.15	4.8	3.94	0.87	0.28	2.28	3.15	0.31	14,74	
T 70	1	1	0.94	10.94	2.8	1.97	4.76	7.17	4.17	3.54	5.28	4.41	0.87	0.28	2.48	3.66	0.39	23,1	
T 76	1 1/4	1 1/4	1.02	13.31	3.15	2.2	5.35	7.99	4.61	3.94	6.1	4.92	1.18	0.35	3.15	4.13	0.39	40,7	
TP 80	3/4	3/4	1.06	13.07	3.15	1.38	5.31	7.99	4.61	3.94	6.1	4.92	1.18	0.35	2.36	4.09	0.39	36,08	

Rated currents

P ₂ HP	115 V 1~ I _N A	230 V 1~ I _N A	I _A /I _N
0,33	7,4	3,7	2,3
0,5	8,4	4,2	2,5
1	14,4	7,2	2,9
1,5	14,8	7,4	3

P ₂ HP	230/460V 3~ I _N A	I _A /I _N
0,33	1.9/1.2	3,8
0,5	2.4/1.6	3,5
0,75	3.8/2.3	6,8
1	4.9/3.2	5,5

P₂ Rated motor power output.

I_A/I_N D.O.L. starting current / Rated current

Characteristic curves n = 3450 rpm

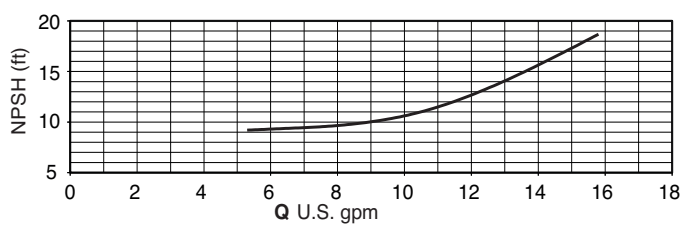
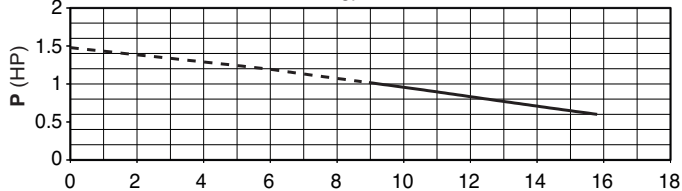
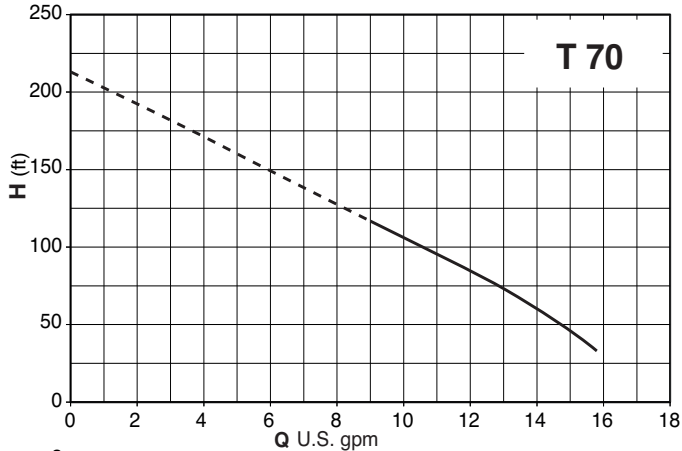
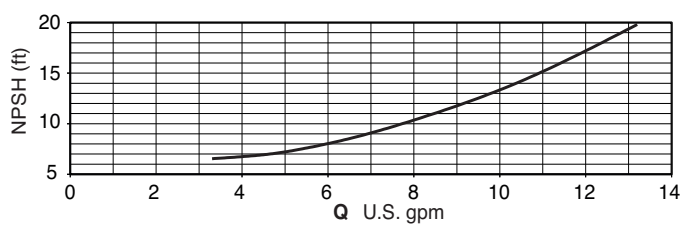
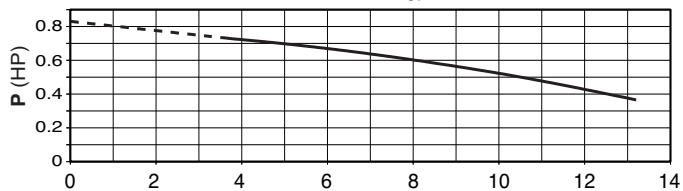
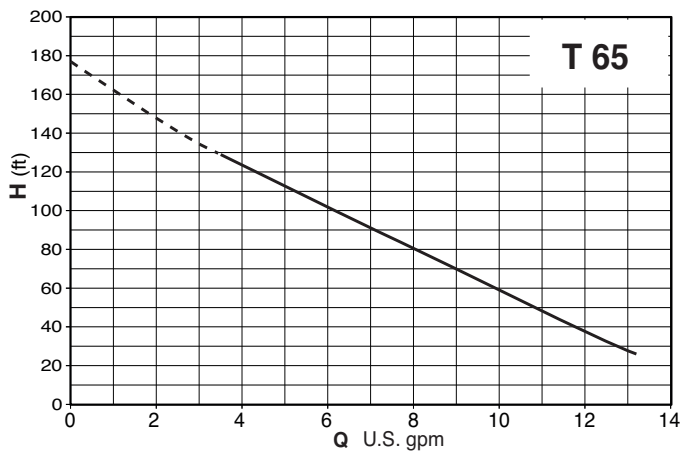
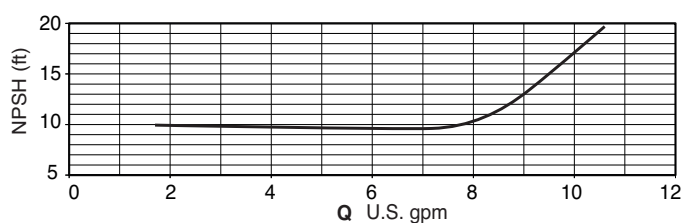
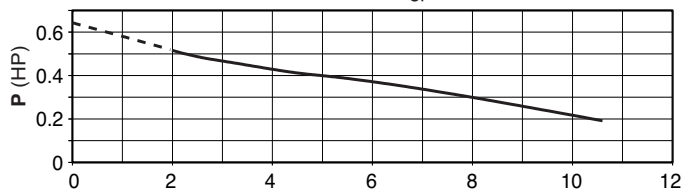
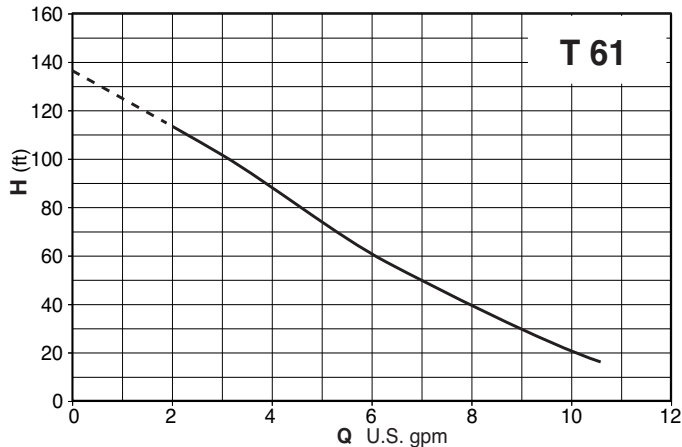
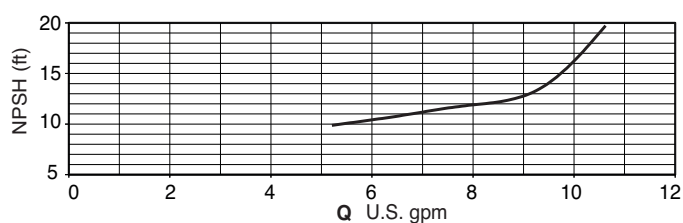
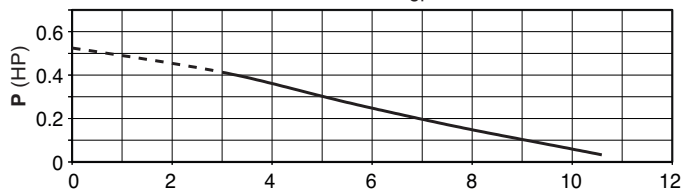
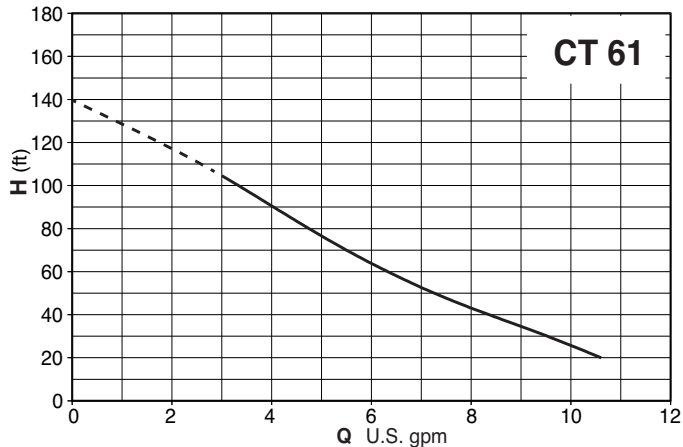

Characteristic curves n = 3450 rpm

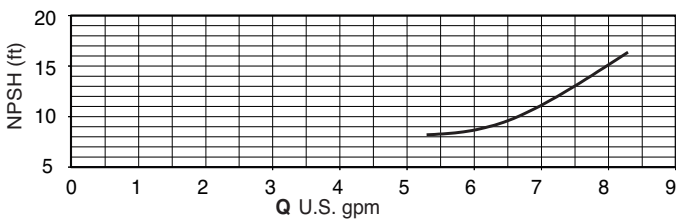
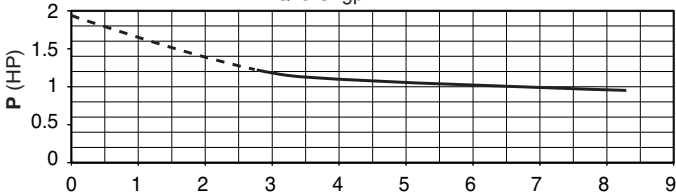
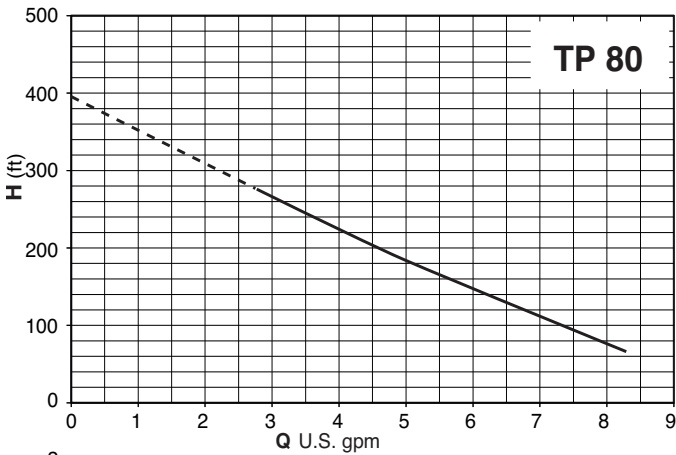
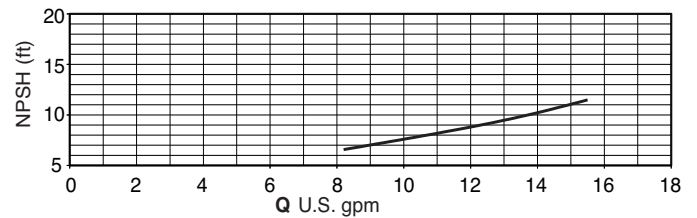
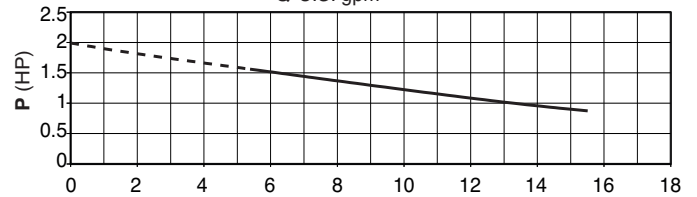
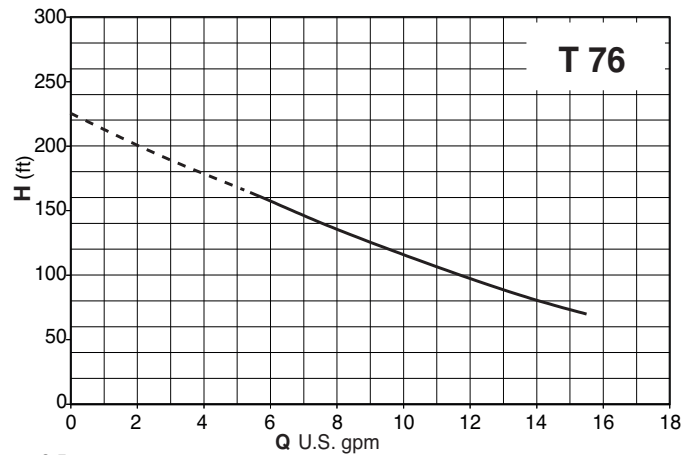
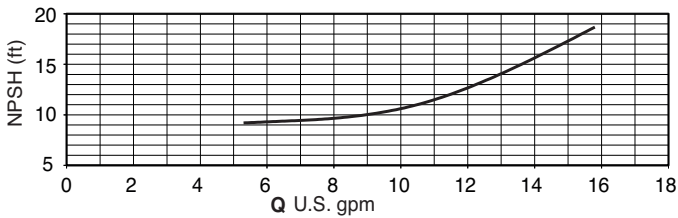
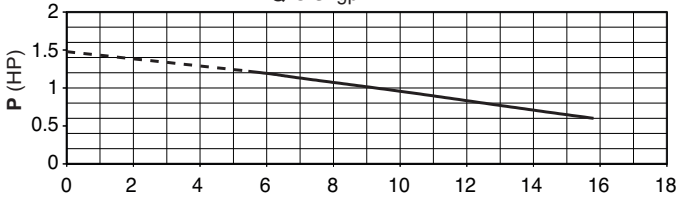
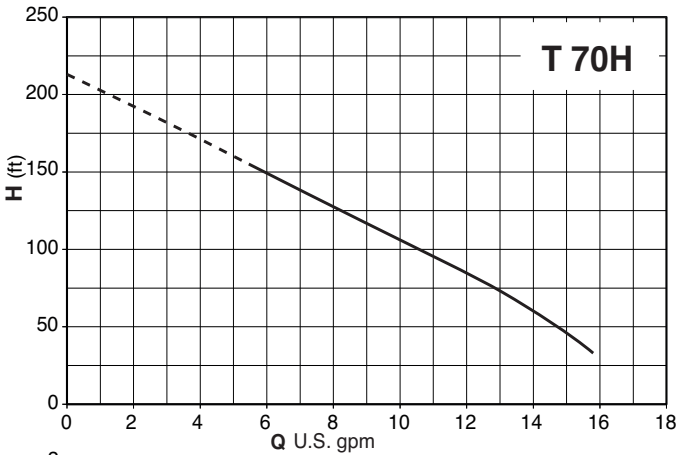

Features

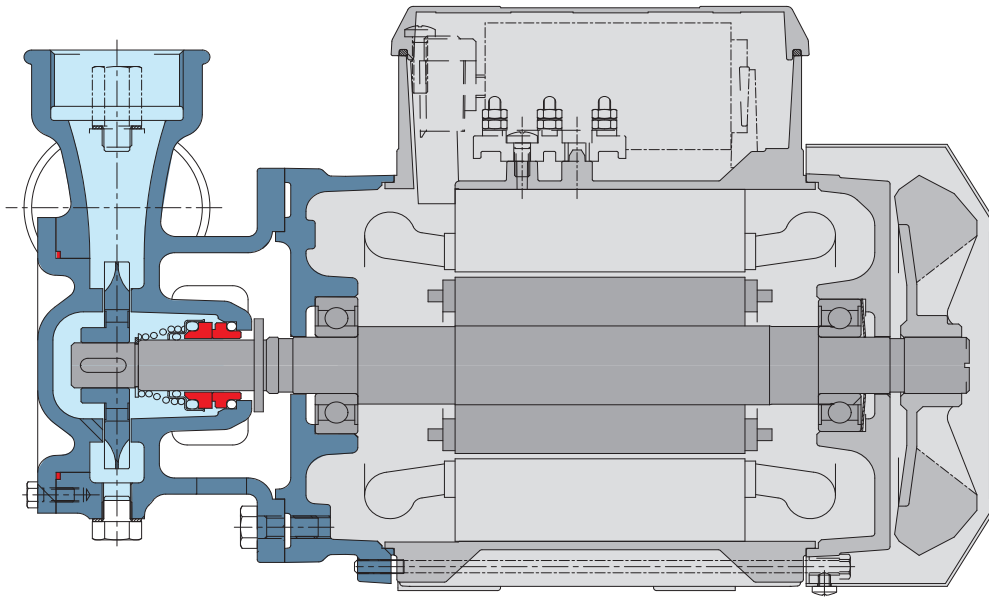

Range

The high number of pumps in the range can meet the widest range of services required by the user.

Flexibility

The option to choose between cast iron and bronze materials for the hydraulic parts in contact with the pumped liquid allows T-TP series pumps to be selected for use with different types of liquids.

Reliability

The bearing and shaft are designed to ensure the reduction of the stress, providing high reliability under all operating conditions.

Optimized hydraulics

The pump hydraulics are designed to ensure high performance and consistency of performance.