

Classis GM 302 - 306

Gooseneck Microphones



GM 303



GM 305 S

FEATURES

- RFI-proof due to Scudio™ technology
- High sensitivity
- High gain before feedback
- Unobtrusive due to small dimensions
- Non-glare surface
- Phantom power 8 - 52 volts

VERSIONS

Classis GM 302	XLR plug, 200 mm [8"]	Order # 489.557
Classis GM 303	XLR plug, 300 mm [12"]	Order # 722.383
Classis GM 303 S	same as above, but with switch.	Order # 489.549
Classis GM 304	XLR plug, 400 mm [16"]	Order # 722.391
Classis GM 304 S	same as above, but with switch.	Order # 489.301
Classis GM 305	XLR plug, 500 mm [20"]	Order # 722.405
Classis GM 305 S	same as above, but with switch.	Order # 722.413
Classis GM 306	XLR plug, 600 mm [24"]	Order # 724.246
Classis GM 305 T	5/8" internal thread / adapter to 3/8" and M18x0.75 external thread, length 500 mm [20"], connecting cable 2.5 m [8.2 ft] with 4-pin female mini XLR connector, incl. CVE 305.18 pre-amp, ZSH 305 small base plate, wind shield.	Order # 722.421

APPLICATIONS

The gooseneck microphones of the Classis series integrate cardioid electret microphones inside the very small microphone head. They can be used for all kinds of applications where a high-quality, but also discrete microphone is demanded.

Due to the cardioid polar pattern this microphone has a high gain before feedback and provides highest intelligibility of speech. Therefore, the microphones are ideal for the use with lecterns, sound reinforcement applications, conferencing, high quality talkback and paging systems.

All microphones feature the innovative Scudio™ technology, making the microphones absolutely insensitive to wireless communication devices such as mobile phones.

The microphone is mounted on a 6 mm thick gooseneck and due to its mat black, non-glare surface almost invisible.

The microphones can be powered with any phantom power source supplying 8 to 52 volts.

SUPPLIED ACCESSORY

WS 302 B	Wind shield for Classis GM 302 - 3x5 (S), black	Order # 722.782
----------	---	-----------------

OPTIONAL ACCESSORIES

ZSA 305	Mounting adapter for the use of Classis GM 305 T with ZSH 20.	Order # 723.037
ZSH 23 FT	Base plate with 3-pin XLR-socket and cable	Order # 464.902
ZSH 20	Shock-mounted holder for desktop installation	Order # 454.559

Classis GM 302 - 306

TECHNICAL SPECIFICATIONS

Transducer type	Electret condenser
Operating principle	Pressure gradient
Polar pattern	Cardioid
Frequency response	50 - 19,000 Hz
Open circuit voltage	17 mV/Pa
Nominal impedance	< 200 Ω
Load impedance	≥ 1 kΩ
Signal to noise ratio / noise voltage	69 dB [A] / 6.0 μV [A]
Max. SPL	107 dB [SPL @ 1% THD]
Equivalent SPL	25 dB [A]
Wiring GM 30x/30x S	balanced with 3-pin XLR-plug

Wiring GM 305 T	balanced, 2.5 m [8.2 ft.] long connecting cable with 4-pin female mini XLR connector for CVE 305.18 pre-amp with 3-pin XLR connector
Supply voltage GM 30x	Phantom power 8 - 52 V
Supply voltage GM 30x S	Phantom power 8 - 52 V
Current consumption GM 30x	2 mA
Current consumption GM 30x S	6 mA
Dimensions	
Length	depending on the version
Head diameter	13.6 mm [0.5"]
Gooseneck diameter	6 mm [0.2"]
Shaft diameter	20 mm [0.8"]
Weight	depending on the version

FREQUENCY RESPONSE & POLAR PATTERN

This frequency response curve (measuring tolerance ± 2.5 dB) and polar pattern correspond to a typical production sample for this microphone.

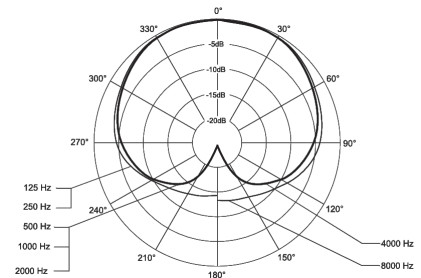
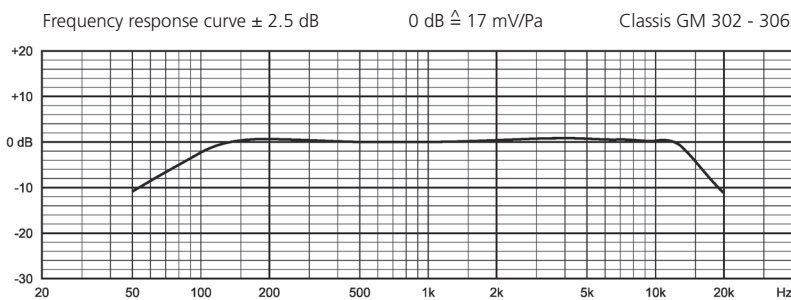

WIRING DIAGRAMS

Classis GM 302 - 306

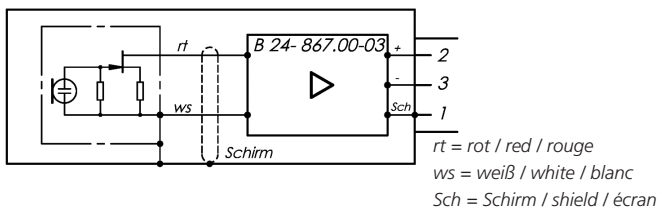

Classis GM 303 S - 305 S

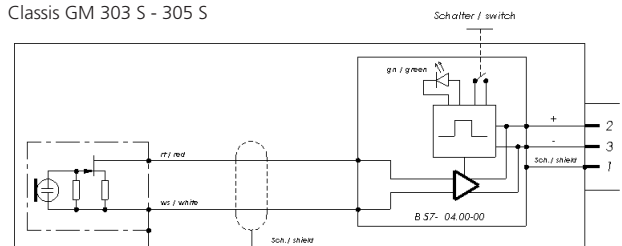

Classis GM 305 T

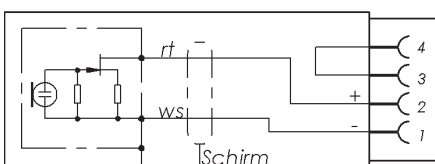

CVE 305.18

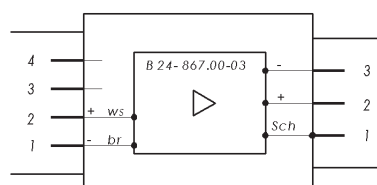

br = braun / brown / brun
rt = rot / red / rouge
ws = weiß / white / blanc
Sch = Schirm / shield / écran

Classis GM 302 - 306

DIMENSIONS

GM 302

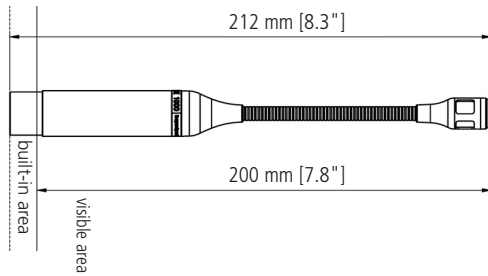

GM 303

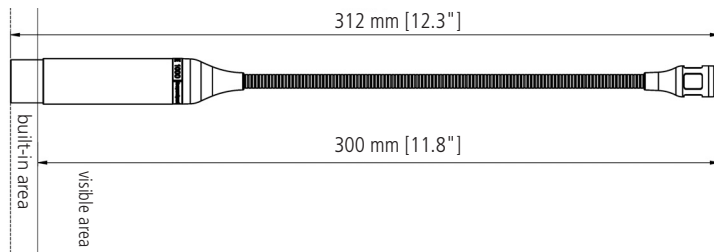

GM 304

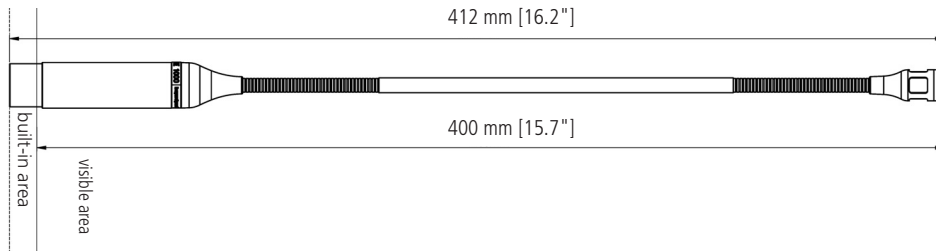

GM 305

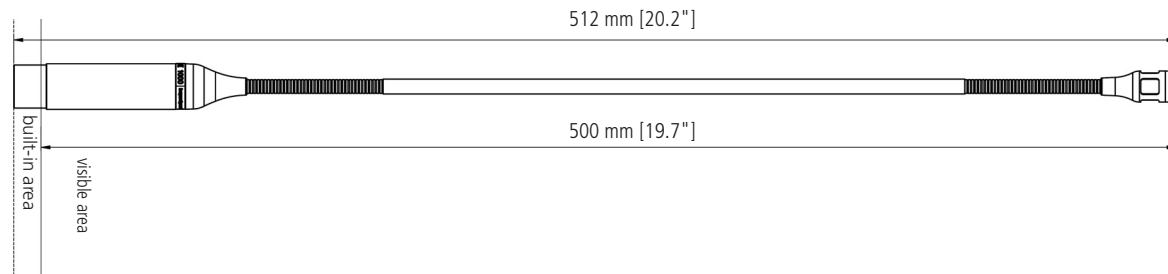

Classis GM 302 - 306

DIMENSIONS

GM 306

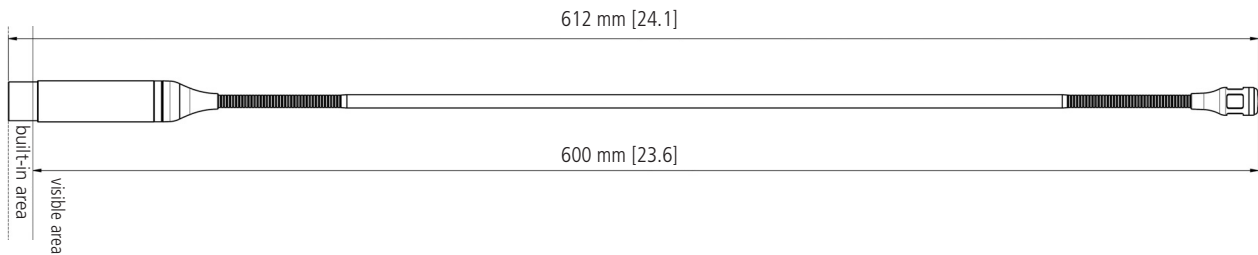

GM 303 S

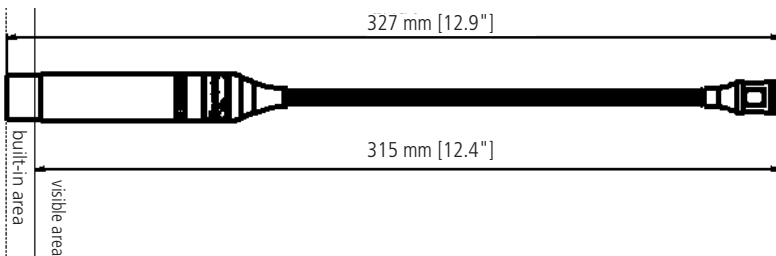

GM 304 S

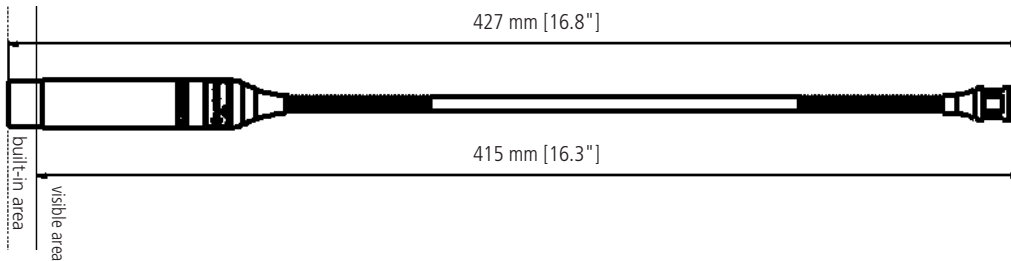

GM 305 S

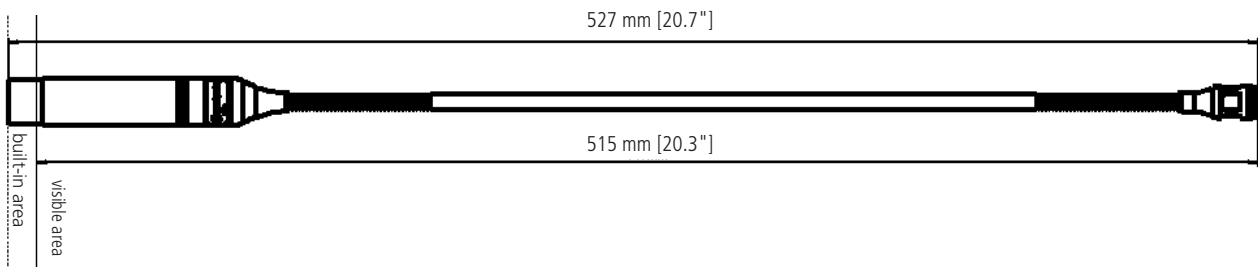

Classis GM 302 - 306

DIMENSIONS

GM 305 T

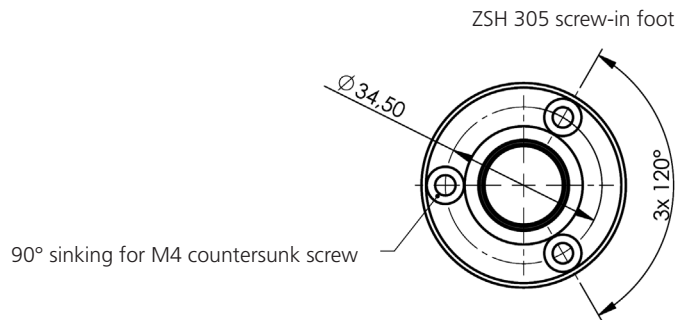
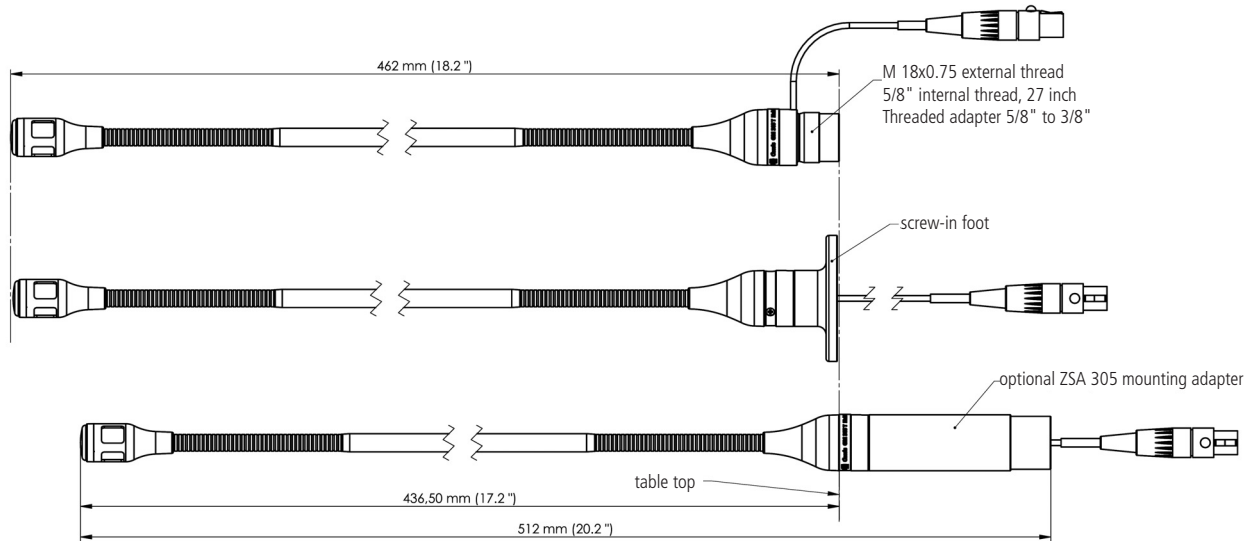

Classis GM 302 - 306

ARCHITECT'S SPECIFICATIONS

The cardioid electret condenser microphone shall be used as a high-quality conference, paging and PA microphone. The phantom power shall be between 8 and 52 V. The filter in the microphone grille shall eliminate wind and pop noise. The SCUDIO® technology shall eliminate interferences of other wireless communication devices. The fully metal housing shall be non-glare and black. The gooseneck shall provide a thickness of 6 mm [0.2"] and a total length of 212 mm [8.3"]. The microphone diameter shall be 13.6 mm [0.5"]. A pre-amplifier shall be integrated in the base and provided with a balanced signal output. The frequency response shall be 50 - 19,000 Hz. The open circuit voltage shall be 17 mV/Pa. The nominal impedance shall be 200 ohms. The microphone shall be provided with a 3-pin male XLR connector. The net weight shall be 0.121 kg [0.23 lbs].

Manufacturer: beyerdynamic
Type: Classis GM 302

The cardioid electret condenser microphone shall be used as a high-quality conference, paging and PA microphone. The phantom power shall be between 8 and 52 V. The filter in the microphone grille shall eliminate wind and pop noise. The SCUDIO® technology shall eliminate interferences of other wireless communication devices. The fully metal housing shall be non-glare and black. The gooseneck shall provide a thickness of 6 mm [0.2"] and a total length of 312 mm [12.3"]. The microphone diameter shall be 13.6 mm [0.5"]. A pre-amplifier shall be integrated in the base and provided with a balanced signal output. The frequency response shall be 50 - 19,000 Hz. The open circuit voltage shall be 17 mV/Pa. The nominal impedance shall be 200 ohms. The microphone shall be provided with a 3-pin male XLR connector. The net weight shall be 0.132 kg [0.23 lbs].

Manufacturer: beyerdynamic
Type: Classis GM 303

The cardioid electret condenser microphone shall be used as a high-quality conference, paging and PA microphone. The phantom power shall be between 8 and 52 V. The filter in the microphone grille shall eliminate wind and pop noise. The SCUDIO® technology shall eliminate interferences of other wireless communication devices. The microphone shall feature a radial slide switch with two defined snap-in points and one green status LED. The fully metal housing shall be non-glare and black. The gooseneck shall provide a thickness of 6 mm [0.2"] and a total length of 327 mm [12.9"]. The microphone diameter shall be 13.6 mm [0.5"]. A pre-amplifier shall be integrated in the base and provided with a balanced signal output. The frequency response shall be 50 - 19,000 Hz. The open circuit voltage shall be 17 mV/Pa. The nominal impedance shall be 200 ohms. The microphone shall be provided with a 3-pin male XLR connector. The net weight shall be 0.150 kg [0.330 lbs].

Manufacturer: beyerdynamic
Type: Classis GM 303 S

The cardioid electret condenser microphone shall be used as a high-quality conference, paging and PA microphone. The phantom power shall be between 8 and 52 V. The filter in the microphone grille shall eliminate wind and pop noise. The SCUDIO® technology shall eliminate interferences of other wireless communication devices. The fully metal housing shall be non-glare and black. The microphone shall feature 2 x 6 mm [2 x 0.2"] goosenecks with a rigid tube in between and a total length of 412 mm [16.2"]. The microphone diameter shall be 13.6 mm [0.5"]. A pre-amplifier shall be integrated in the base and provided with a balanced signal output. The frequency response shall be 50 - 19,000 Hz. The open circuit voltage shall be 17 mV/Pa. The nominal impedance shall be 200 ohms. The microphone shall be provided with a 3-pin male XLR connector. The net weight shall be 0.145 kg [0.32 lbs].

Manufacturer: beyerdynamic
Type: Classis GM 304

The cardioid electret condenser microphone shall be used as a high-quality conference, paging and PA microphone. The phantom power shall be between 8 and 52 V. The filter in the microphone grille shall eliminate wind and pop noise. The microphone shall feature a radial slide switch with two defined snap-in points and one green status LED. The SCUDIO® technology shall eliminate interferences of other wireless communication devices. The fully metal housing shall be non-glare and black. The microphone shall feature 2 x 6 mm [0.2"] goosenecks with a rigid tube in between and a total length of 427 mm [16.8"]. The microphone diameter shall be 13.6 mm [0.5"]. A pre-amplifier shall be integrated in the base and provided with a balanced signal output. The frequency response shall be 50 - 19,000 Hz. The open circuit voltage shall be 17 mV/Pa. The nominal impedance shall be 200 ohms. The microphone shall be provided with a 3-pin male XLR connector. The net weight shall be 0.163 kg [0.359 lbs].

Manufacturer: beyerdynamic
Type: Classis GM 304 S

Classis GM 302 - 306

ARCHITECT'S SPECIFICATIONS

The cardioid electret condenser microphone shall be used as a high-quality conference, paging and PA microphone. The phantom power shall be between 8 and 52 V. The filter in the microphone grille shall eliminate wind and pop noise. The SCUDIO® technology shall eliminate interferences of other wireless communication devices. The fully metal housing shall be non-glare and black. The microphone shall feature 2 x 6 mm [2 x 0.2"] goosenecks with a rigid tube in between and a total length of 512 mm [20.2"]. The microphone diameter shall be 13.6 mm [0.5"]. A pre-amplifier shall be integrated in the base and provided with a balanced signal output. The frequency response shall be 50 - 19,000 Hz. The open circuit voltage shall be 17 mV/Pa. The nominal impedance shall be 200 ohms. The microphone shall be provided with a 3-pin male XLR connector. The net weight shall be 0.156 kg [0.34 lbs].

Manufacturer: beyerdynamic
Type: Classis GM 305

The cardioid electret condenser microphone shall be used as a high-quality conference, paging and PA microphone. The phantom power shall be between 8 and 52 V. The filter in the microphone grille shall eliminate wind and pop noise. The SCUDIO® technology shall eliminate interferences of other wireless communication devices. The fully metal housing shall be non-glare and black. The microphone shall feature 2 x 6 mm [2 x 0.2"] goosenecks with a rigid tube in between and a total length of 612 mm [24.1"]. The microphone diameter shall be 13.6 mm [0.5"]. A pre-amplifier shall be integrated in the base and provided with a balanced signal output. The frequency response shall be 50 - 19,000 Hz. The open circuit voltage shall be 17 mV/Pa. The nominal impedance shall be 200 ohms. The microphone shall be provided with a 3-pin male XLR connector. The net weight shall be 0.167 kg [0.37 lbs].

Manufacturer: beyerdynamic
Type: Classis GM 306

The cardioid electret condenser microphone shall be used as a high-quality conference, paging and PA microphone. The phantom power shall be between 8 and 52 V. The filter in the microphone grille shall eliminate wind and pop noise. The microphone shall feature a radial slide switch with two defined snap-in points and one green status LED. The SCUDIO® technology shall eliminate interferences of other wireless communication devices. The fully metal housing shall be non-glare and black. The microphone shall feature 2 x 6 mm [2 x 0.2"] goosenecks with a rigid tube in between and a total length of 527 mm [20.7"]. The microphone diameter shall be 13.6 mm [0.5"]. A pre-amplifier shall be integrated in the base and provided with a balanced signal output. The frequency response shall be 50 - 19,000 Hz. The open circuit voltage shall be 17 mV/Pa. The nominal impedance shall be 200 ohms. The microphone shall be provided with a 3-pin male XLR connector. The net weight shall be 0.174 kg [0.384 lbs].

Manufacturer: beyerdynamic
Type: Classis GM 305 S

The cardioid electret condenser microphone shall be used as a high-quality conference, paging and PA microphone. The phantom power shall be between 8 and 52 V. The filter in the microphone grille shall eliminate wind and pop noise. The SCUDIO® technology shall eliminate interferences of other wireless communication devices. The fully metal housing shall be non-glare and black. The microphone shall feature 2 x 6 mm [2 x 0.2"] goosenecks with a rigid tube in between and a total length of 462 mm [18.2"] without mounting adapter. The microphone diameter shall be 13.6 mm [0.5"]. The connected CVE 305.18 pre-amp shall be provided with a 4-pin male mini XLR and 3-pin male XLR connector with balanced signal output. The frequency response shall be 50 - 19,000 Hz. The open circuit voltage shall be 17 mV/Pa. The nominal impedance shall be 200 ohms. The connecting cable shall be 2.5 m [8.2 ft] long with a 4-pin female mini XLR connector. The 5/8" internal thread shall provide an adapter to 3/8". The M18x0.75 external thread shall be provided with a screw-type thread cover with cable outlet when mounting via the internal thread. The microphone shall be supplied with the ZSH 305 base plate for mounting on a table via the M18x0.75 external thread. An optional ZSA 305 mounting adapter shall be available for installation with the ZSH 20 holder (optional) decoupled from mechanical noise and vibration. The net weight shall be 0.147 kg [0.324 lbs].

Manufacturer: beyerdynamic
Type: Classis GM 305 T