

Visionary™ Boards w/ Glass Tray

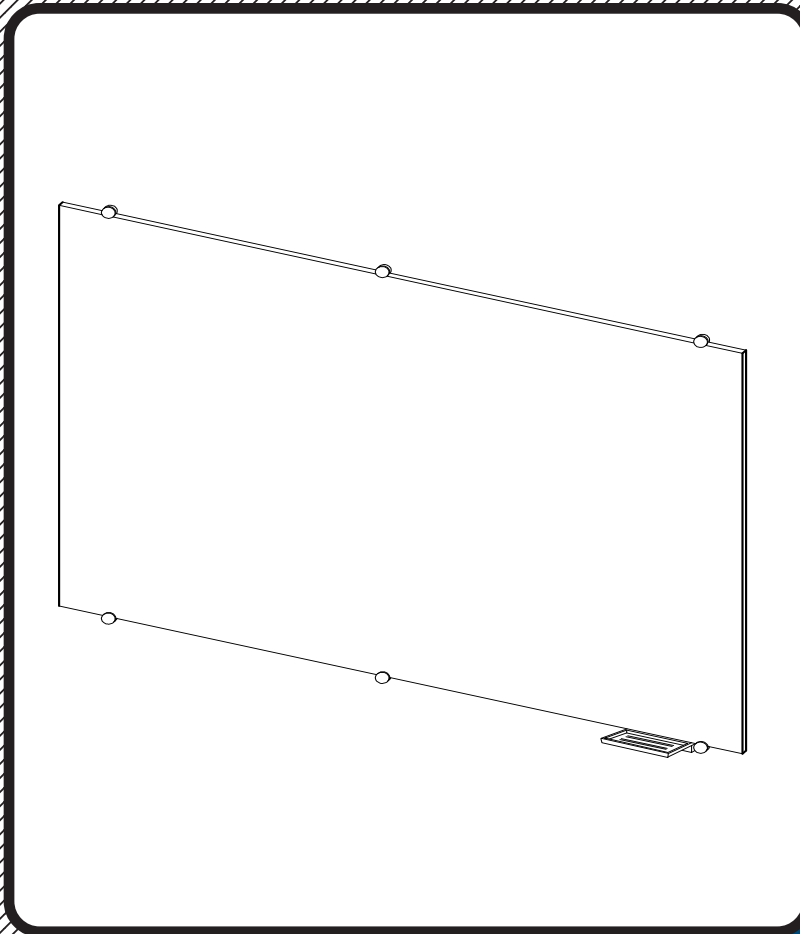

Assembly Instructions

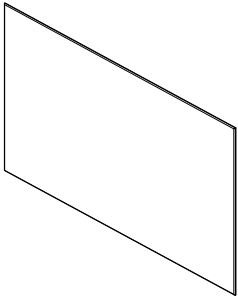

Visionary™ Board

Part	Drawing	Description	Qty	Part	Drawing	Description	Qty
------	---------	-------------	-----	------	---------	-------------	-----

P-1		Glass Board	1 EA
-----	---	-------------	------

P-2		Glass Tray	1 EA
-----	---	------------	------

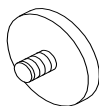
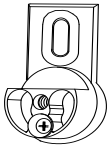
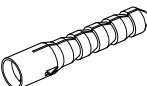
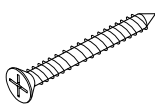
Hardware Chart by Board Size	
2'X3' GBoard	- 4 pcs. (A), (B) 6 pcs. (C), (D), (F) 2 pcs. (E)
3'X4' GBoard	- 4 pcs. (A), (B) 6 pcs. (C), (D), (F) 2 pcs. (E)
4'X4' PJWBoard	- 4 pcs. (A), (B) 6 pcs. (C), (D), (F) 2 pcs. (E)
4'X6' GBoard	- 6 pcs. (A), (B) 8 pcs. (C), (D), (F) 2 pcs. (E)
4'X8' GBoard	- 8 pcs. (A), (B) 10 pcs. (C), (D), (F) 2 pcs. (E)
4'X4' PJGBoard	- 4 pcs. (A), (B) 6 pcs. (C), (D), (F) 2 pcs. (E)
4'X6' PJWBoard	- 6 pcs. (A), (B) 8 pcs. (C), (D), (F) 2 pcs. (E)
4'X6' PJGBoard	- 6 pcs. (A), (B) 8 pcs. (C), (D), (F) 2 pcs. (E)

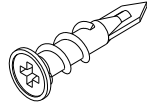
Hardware List			
A		Outer Cap	See Chart
B		Wall Mount	See Chart
C		Plastic Anchor	See Chart
D		CS Screw	See Chart
E		Glass Tray Mount	See Chart
F		Drywall Anchor	See Chart

Preparing to Install Your New Visionary™ Board

- a.) Determine the type wall you are mounting your new board on.
- b.) Measure the length, width and center lines of your board and your wall. Determine the height off the floor that you want the bottom of your board. Most boards are mounted about 36" off the floor.
- c.) With help, hold your board up in position and draw a line around the perimeter. Make sure these drawn lines are parallel with the ceiling and floor.
- d.) If your wall has studs, it is recommended that you mount into as many studs as possible.

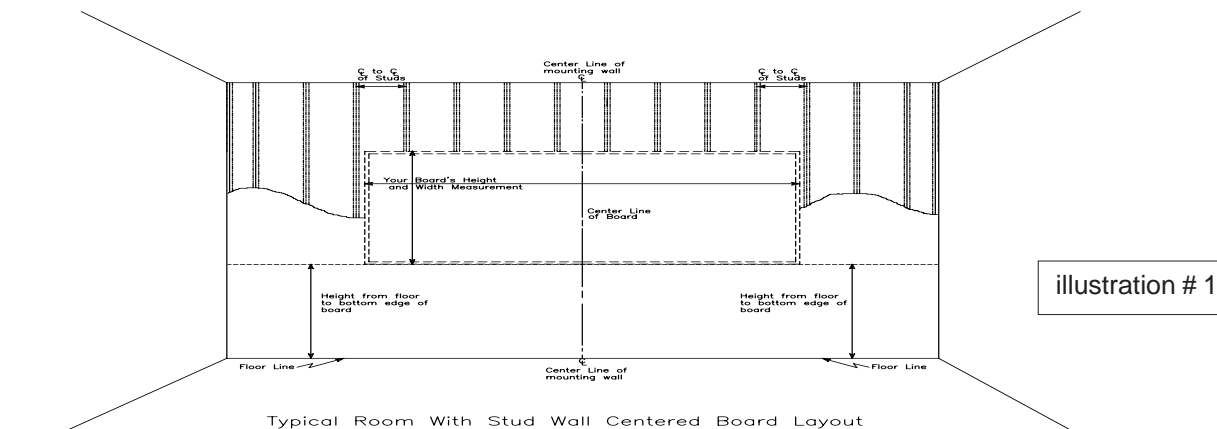

NOTE: The proper installation of your board will require at least two people.
Tools required: Tape measure, chalkline, electric drill / screwdriver, drill and screwdriver bits, stud finder and level.

To Assemble and Attach to Wall:

- 1.) Identify and Separate all the Parts and Hardware.
- 2.) Pick the correct type of mounting hardware and anchors for your type wall .
- 3.) Measure up 1 1/4" above the bottom line and draw another line that is parallel. Measure in about 6" from each side and install your bottom Wall Mounts (B) as shown in illustrations #2 and Detail #2a.

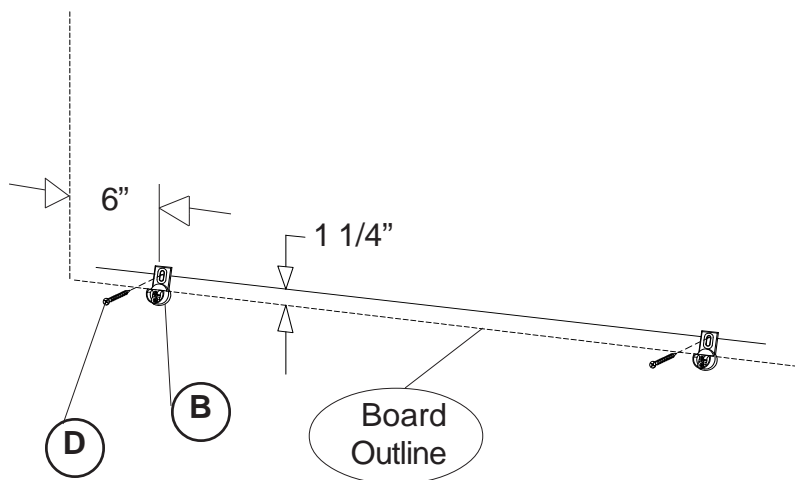
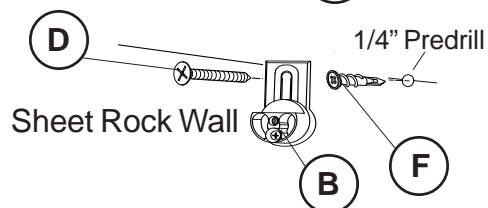
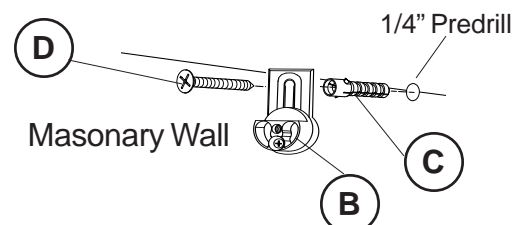
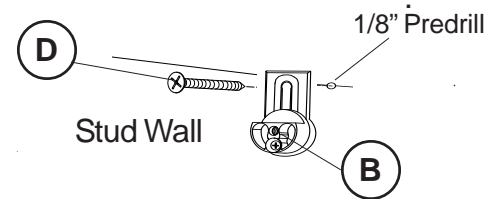
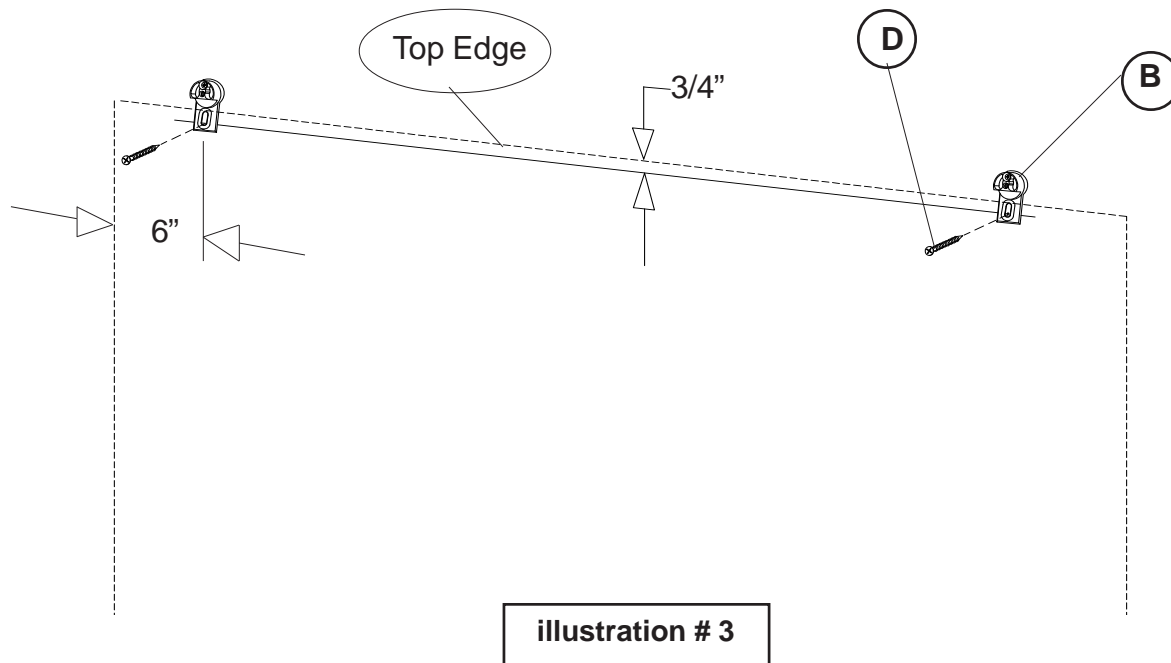

illustration # 2



Detail # 2a

- 4.) Measure down 3/4" from the top line and draw another line that is parallel. Measure in about 6" from each side and install your top Wall Mounts (B). Leave the top Wall Mounts pushed up as shown in illustration #3



- 5.) Place the Glass Board (P1) on the bottom Wall Mounts (B) and screw in the Outer Caps (A) to secure. Tilt the Glass Board back and push down the top Wall Mounts (B) onto the board's top edge. Secure board in place by screwing in the top Outer Caps (A) as shown in illustration #4.

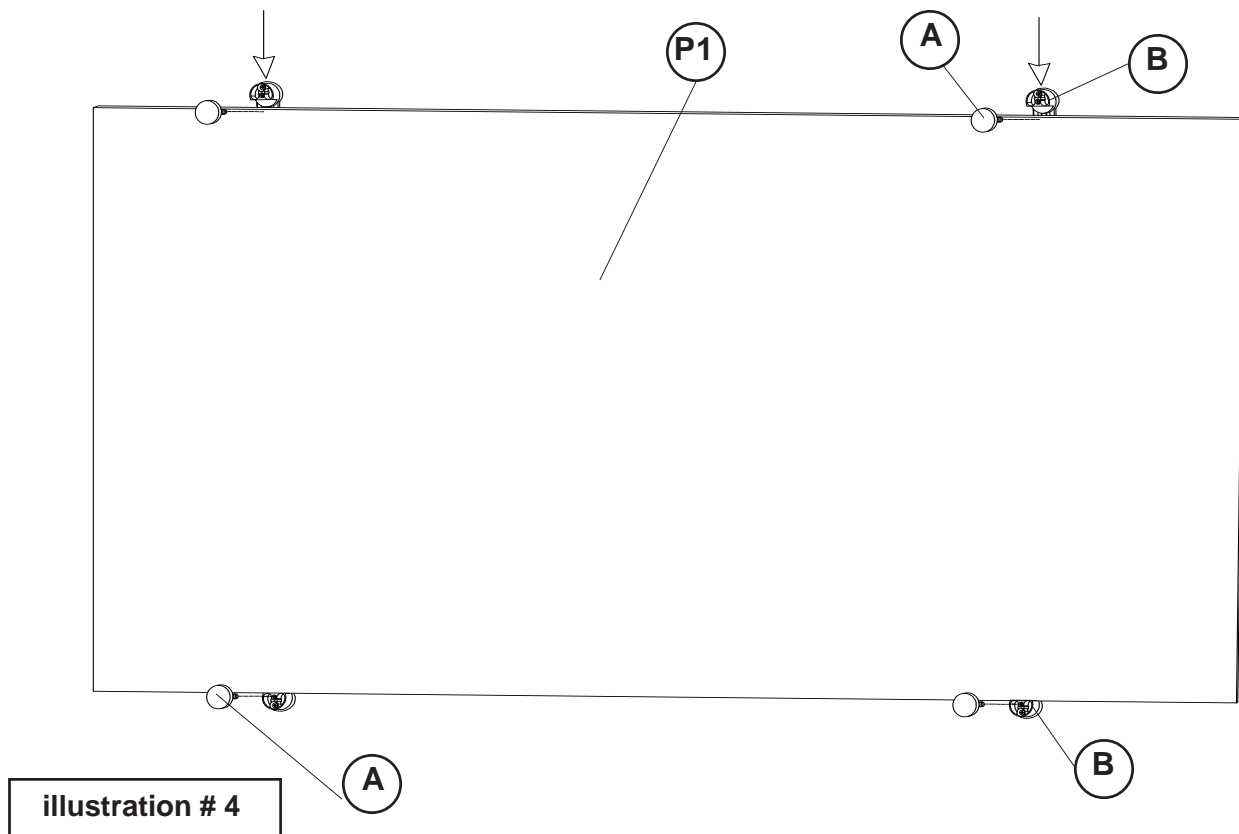

Follow These Instructions to Install the Glass Tray

- 1.) After the board has been installed, pick the location that you would like your tray to be installed.
Mark a line at least 1" down from the bottom of the board. Make sure your location will not interfere with the bottom Mounts that are holding the board.
- 2.) Place the Glass Tray (P-2) on the line and mark the right and left edges of the tray on the line.
Measure in 1" from the edge marks of the tray and make your marks.
- 3.) Predrill two 5/16" diameter holes at your marked points below the Glass Board on the wall.
Push in a Plastic Anchor (C) in each hole. Attach a Glass Tray Mount (E) over the Plastic Anchor (C) using one CS Screw (D) for each mount.

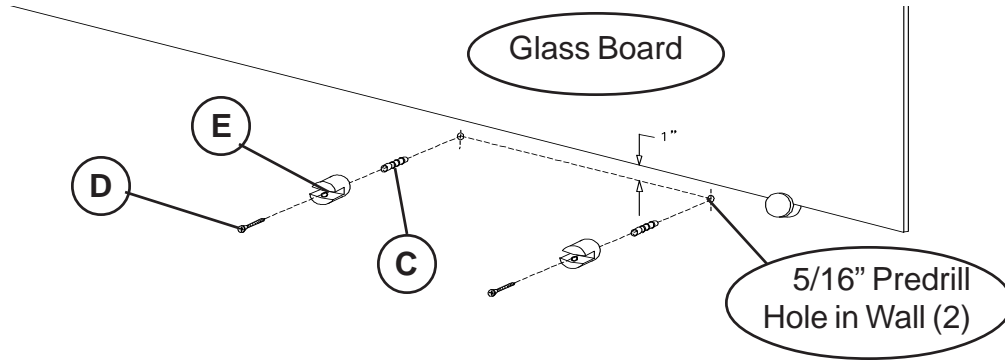

For Drywall :

- 3a.) Screw in a Drywall Anchor (F) at each of your marked points below the Glass Board on the wall.
Attach a Glass Tray Mount (E) over the Drywall Anchor (F) using one CS Screw (D) for each mount.

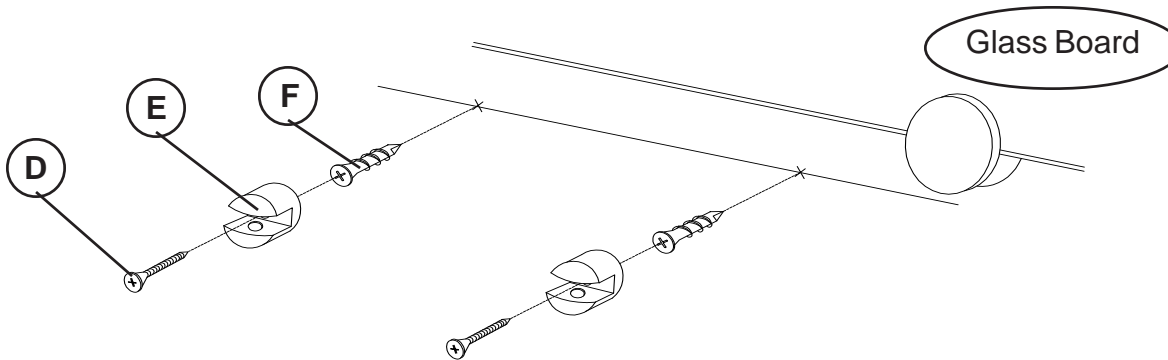

- 4.) Slide in the Glass Tray (P-2) into the slots of the Glass Tray Mounts (E) and secure in place by tightening the plastic set screws in the bottom flange of each mount. as shown in illustration #2.

