

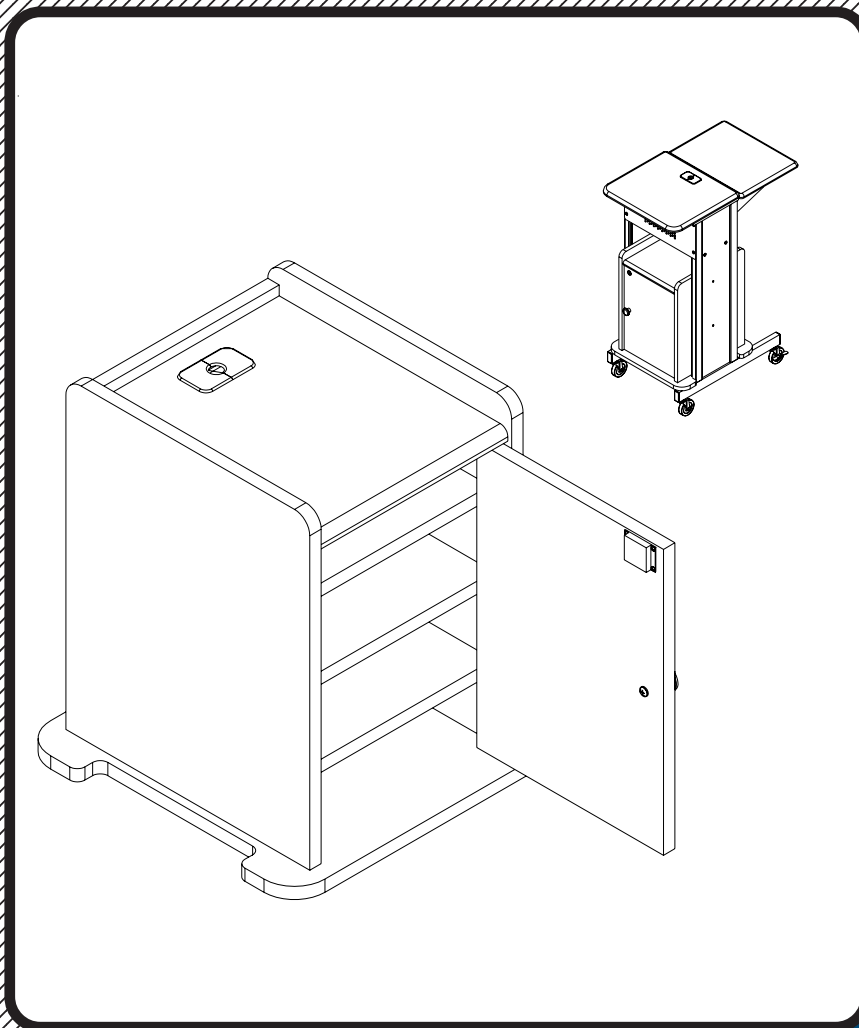











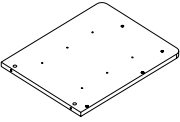





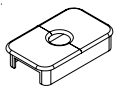
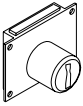

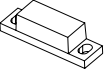







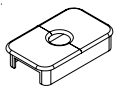
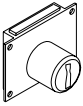

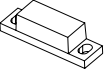

#34409 Security Cabinet

for Presentation Cart #89759

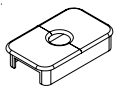
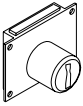

Assembly Instructions

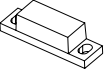
#34409 Security Cabinet

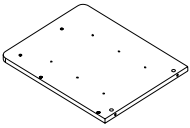
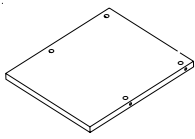
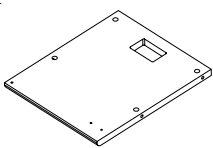
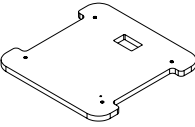
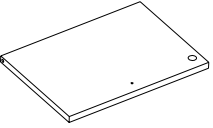
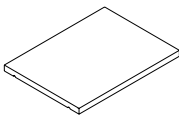
Part	Drawing	Description	Qty	Part	Drawing	Description	Qty																																																
P-1		Left Side Panel	1 EA	<div style="text-align: center; font-weight: bold; margin-bottom: 10px;">Hardware List</div> <table style="width: 100%; border-collapse: collapse;"> <tr> <td style="width: 5%;">A</td> <td style="width: 10%;"></td> <td style="width: 65%;">Short Wood Screw</td> <td style="width: 20%;">6 EA</td> </tr> <tr> <td>A1</td> <td></td> <td>Phillips Head Screw (Door Knob)</td> <td>1 EA</td> </tr> <tr> <td>B</td> <td></td> <td>Metal Support Pins</td> <td>12 EA</td> </tr> <tr> <td>C</td> <td></td> <td>Cam Lock</td> <td>12 EA</td> </tr> <tr> <td>D</td> <td></td> <td>Cam Post</td> <td>12 EA</td> </tr> <tr> <td>E</td> <td></td> <td>Spring Button</td> <td>2 EA</td> </tr> <tr> <td>F</td> <td></td> <td>Plastic Grommet</td> <td>2 EA</td> </tr> <tr> <td>G</td> <td></td> <td>Door Lock w/Lock ring</td> <td>1 EA</td> </tr> <tr> <td>H</td> <td></td> <td>Key</td> <td>2 EA</td> </tr> <tr> <td>J</td> <td></td> <td>Door Knob</td> <td>1 EA</td> </tr> <tr> <td>K</td> <td></td> <td>Door Magnet</td> <td>1 EA</td> </tr> <tr> <td>L</td> <td></td> <td>Allen Wrench</td> <td>1 EA</td> </tr> </table>				A		Short Wood Screw	6 EA	A1		Phillips Head Screw (Door Knob)	1 EA	B		Metal Support Pins	12 EA	C		Cam Lock	12 EA	D		Cam Post	12 EA	E		Spring Button	2 EA	F		Plastic Grommet	2 EA	G		Door Lock w/Lock ring	1 EA	H		Key	2 EA	J		Door Knob	1 EA	K		Door Magnet	1 EA	L		Allen Wrench	1 EA
A		Short Wood Screw	6 EA																																																				
A1		Phillips Head Screw (Door Knob)	1 EA																																																				
B		Metal Support Pins	12 EA																																																				
C		Cam Lock	12 EA																																																				
D		Cam Post	12 EA																																																				
E		Spring Button	2 EA																																																				
F		Plastic Grommet	2 EA																																																				
G		Door Lock w/Lock ring	1 EA																																																				
H		Key	2 EA																																																				
J		Door Knob	1 EA																																																				
K		Door Magnet	1 EA																																																				
L		Allen Wrench	1 EA																																																				
P-2		Right Side Panel	1 EA																																																				
P-3		Back Panel	1 EA																																																				
P-4		Top Panel	1 EA																																																				
P-5		Bottom Platform	1 EA																																																				
P-6		Door	1 EA																																																				
P-7		Removeable Shelf	3 EA																																																				

Do not use unless all screws are tight. At least every six months, check all screws to be sure they are tight. If parts are missing, broken, damaged, or worn, stop use of the product until repairs are made by your dealer using factory authorized parts.

Should you require assistance during assembly, please call our Customer Service Department
Monday - Friday 8 a.m. - 5 p.m.
Central Standard Time
Toll-Free Customer Service
1-800-749-2258

#34409 Security Cabinet

Assembly Diagram

To Assemble:

1. Identify and Separate all the Parts and Hardware.

2. Place the Left Side Panel (P-1) with the Pre drilled holes facing up and install 4 each Cam Posts (D) in the 4 threaded insert nuts (Pre-installed) as shown in illustration # 1.

3. Install 2 each Cam Locks (C) into the large holes as shown in illustration # 1.

4. Repeat Steps 1-3 for the Right Side Panel (P-2).

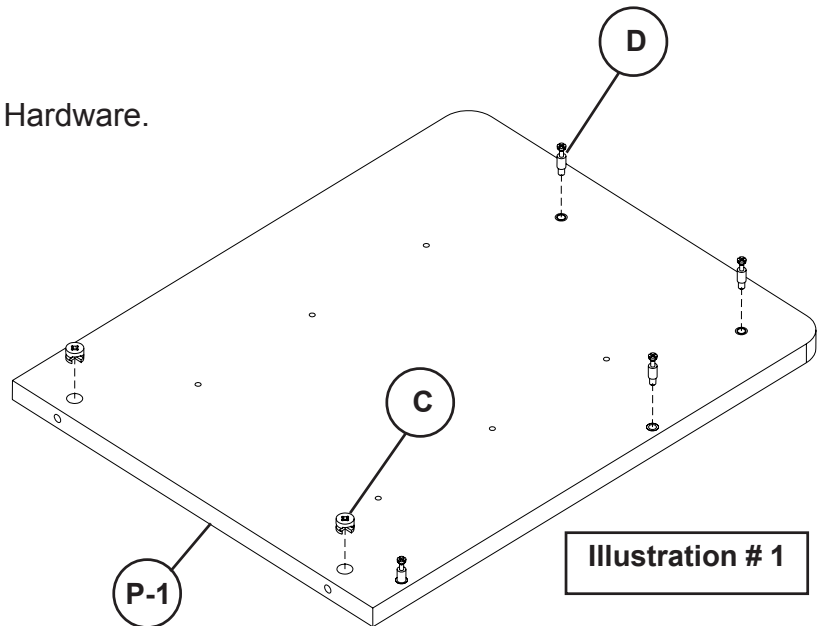

5. Place the Back Panel (P-3) with the Holes facing up and install 4 each Cam Locks (C) into the large holes as shown in illustration # 2.

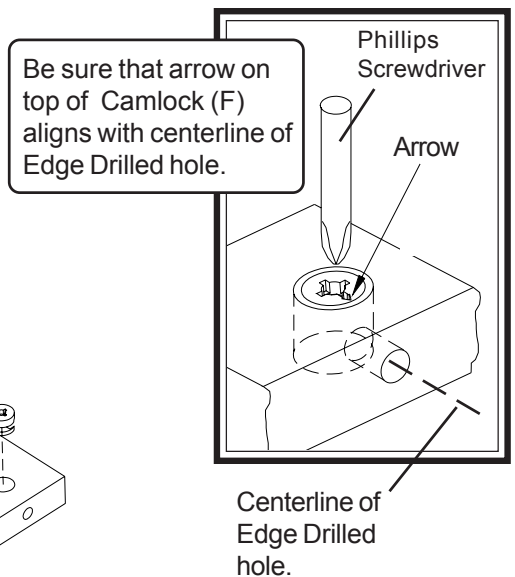
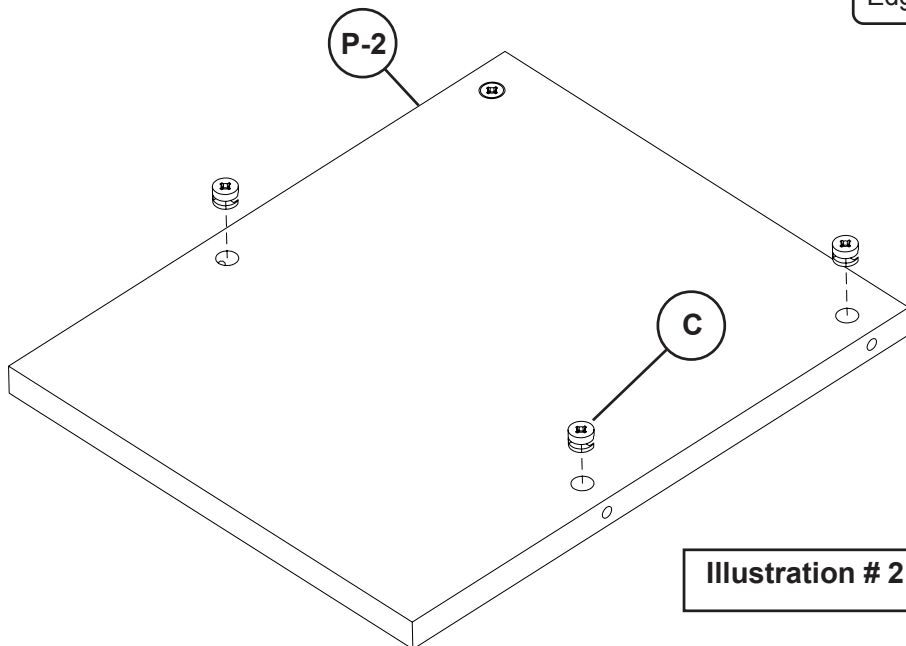

6. Place the Door (P-6) with the 4 Screw Holes facing up and install 1 Lock (G) into the large hole using 4 Wood Screws (A). Press Lock Ring on from front side as shown in illustration # 3.

7. Attach Door Knob (J) to Door (P-6) using 1 each (A1) screw.

8. Locate 2 each Spring Buttons (E) in the top and bottom of door (P-6).

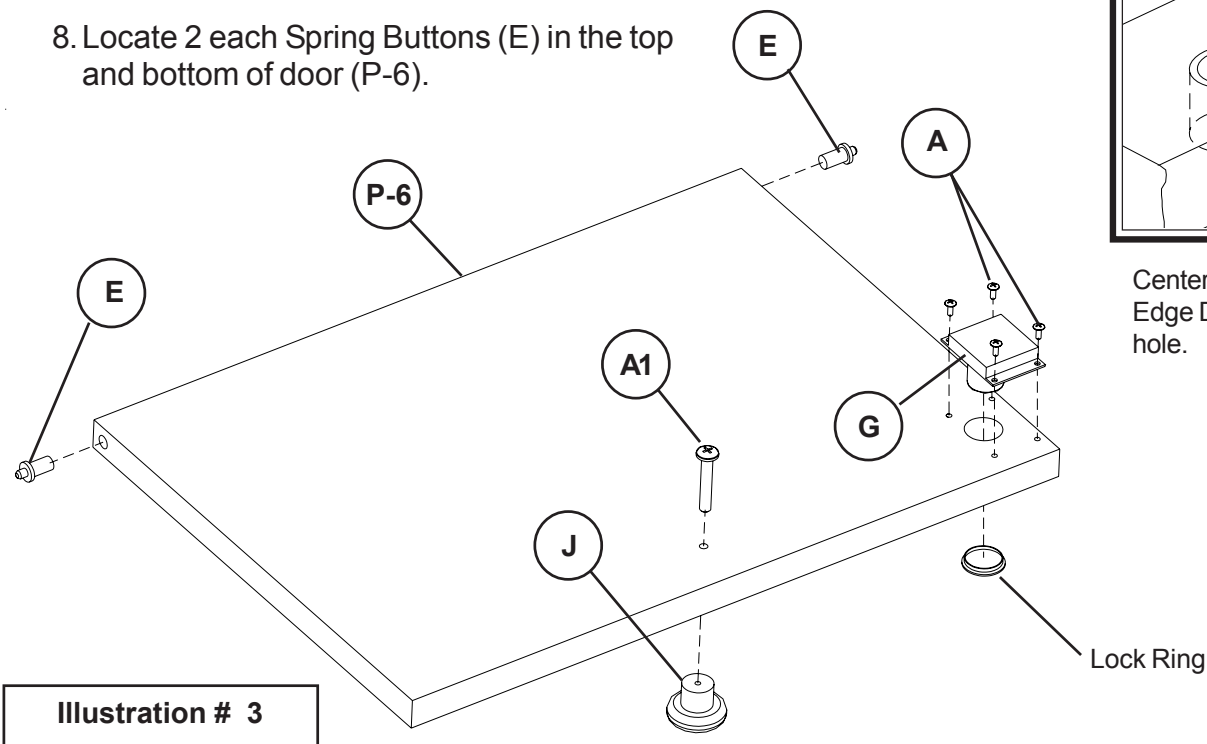
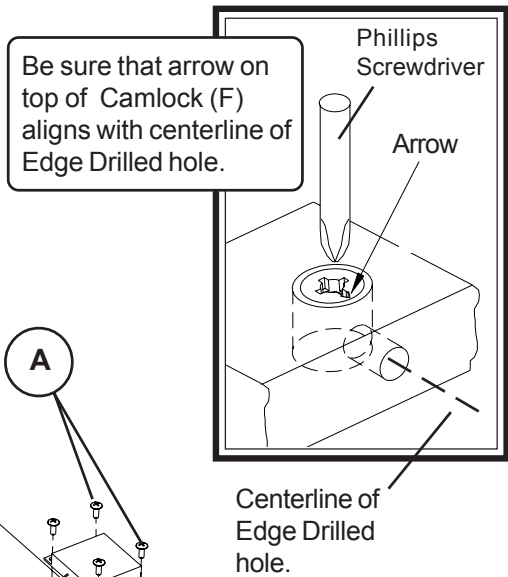

Illustration # 3

9. Place the Top Panel (P-4) with the Holes facing up and install 4 each Cam Locks (C) into the large holes as shown in illustration # 4.

10. Attach 1 each Door Magnet (K) to the Top Panel (P-4) and secure using 2 Wood Screws (A) as shown in illustration # 4.

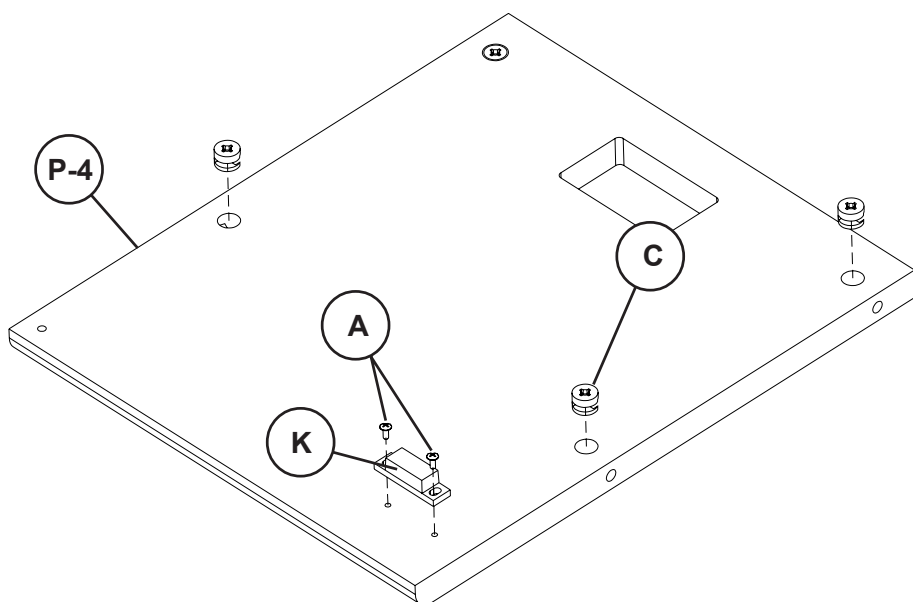

Illustration # 4

Missing Parts or UPS Damaged Parts

For Your Convenience you can
EMAIL us at

furniture@baltinc.com

24HOURS 7 DAYS A WEEK

11. Place the Bottom Platform (P-5) with the Predrilled holes facing up and install 4 each Cam Posts (D) in the 4 threaded insert nuts (Pre-installed) as shown in illustration # 5.

11. To install Grommet (E) in Bottom Platform (P-5), separate parts and press Grommet Sleeve in rectangular opening as shown in illustration # 5.

12. Snap 2 plastic Caps over top of Sleeve as shown in illustration # 5.

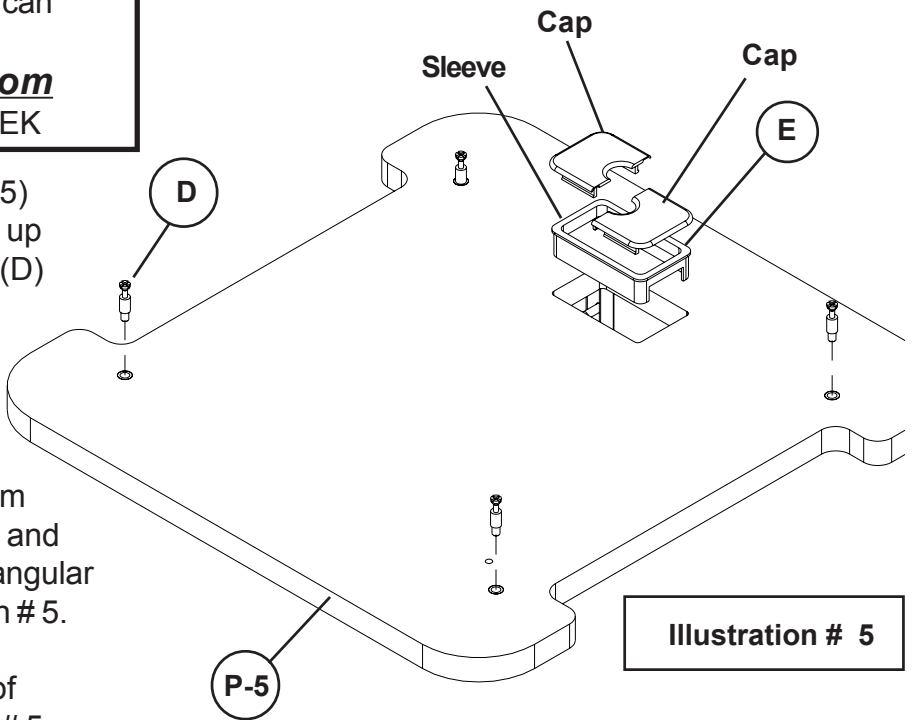

Illustration # 5

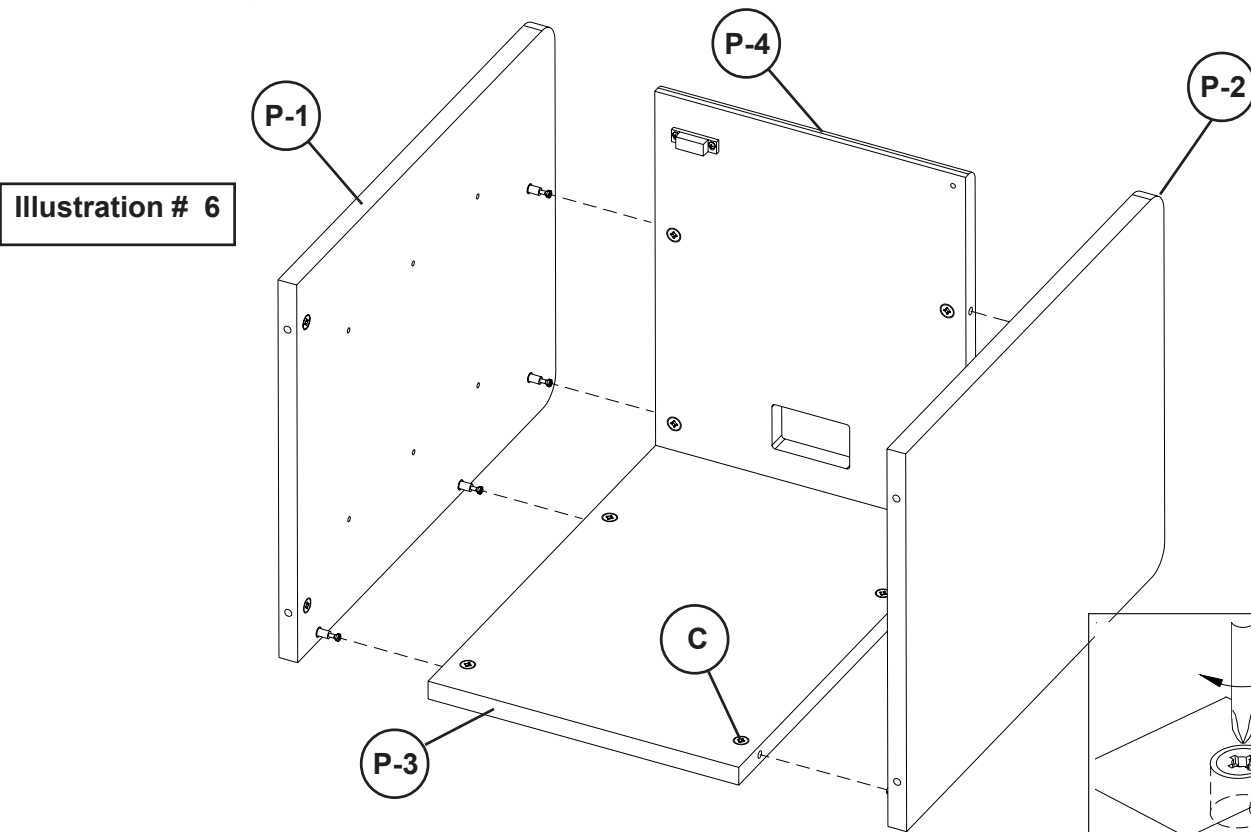

Illustration # 6

13. Attach Side Panels (P-1 & P-2) to the Back Panel (P-3) and the Top Panel (P-4) as shown in illustration # 6. Secure by turning the Cam Locks (C) 1/4" Turn until they lock.

To Secure Cam Locks, Insert Large Phillips Head Screwdriver and turn Cam Lock 1/4 turn (90 degrees) clockwise.

Illustration # 7

14. Remove bottom Shelf from Presentation Cart using Allen Wrench (L). Attach Bottom Shelf (P-5) w/cam posts to the Right & Left Leg Assemblies of Presentation Cart using 4 each screws as shown in illustration # 7.

15. Tighten Screws using Allen Wrench (L).

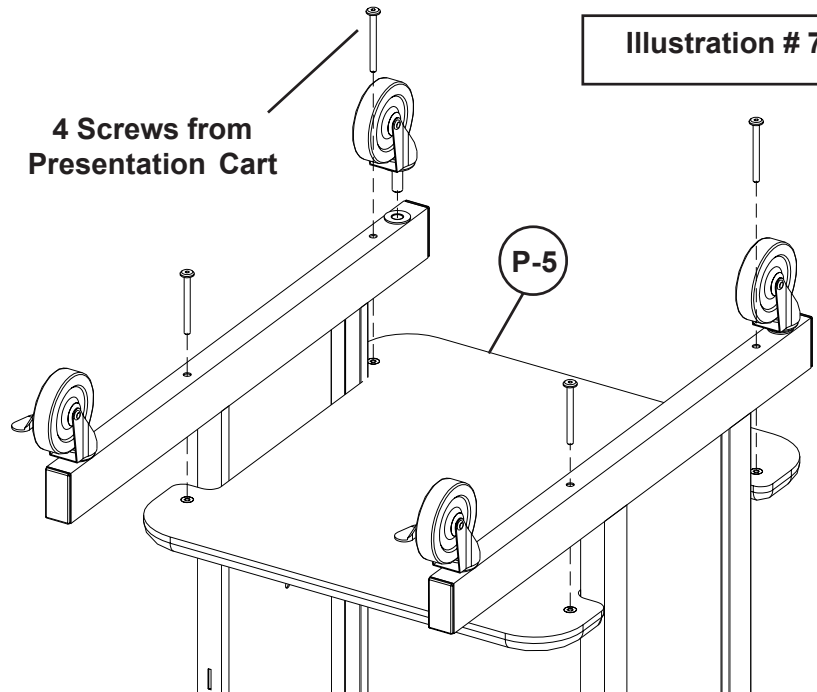

16. To install Grommets (E) in Top Platform (P-4), separate parts and press Grommet Sleeve in rectangular opening as shown in illustration # 8.

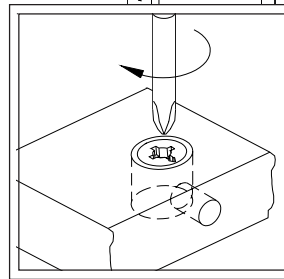

To Secure Cam Locks, Insert Large Phillips Head Screwdriver and turn Cam Lock 1/4 turn (90 degrees) clockwise.

17. Snap 2 plastic Caps over top of Sleeve as shown in illustration # 8.

18. Secure Cabinet assembly to Bottom Panel (P-5) by turning the Cam Locks (C) 1/4 Turn until they lock.

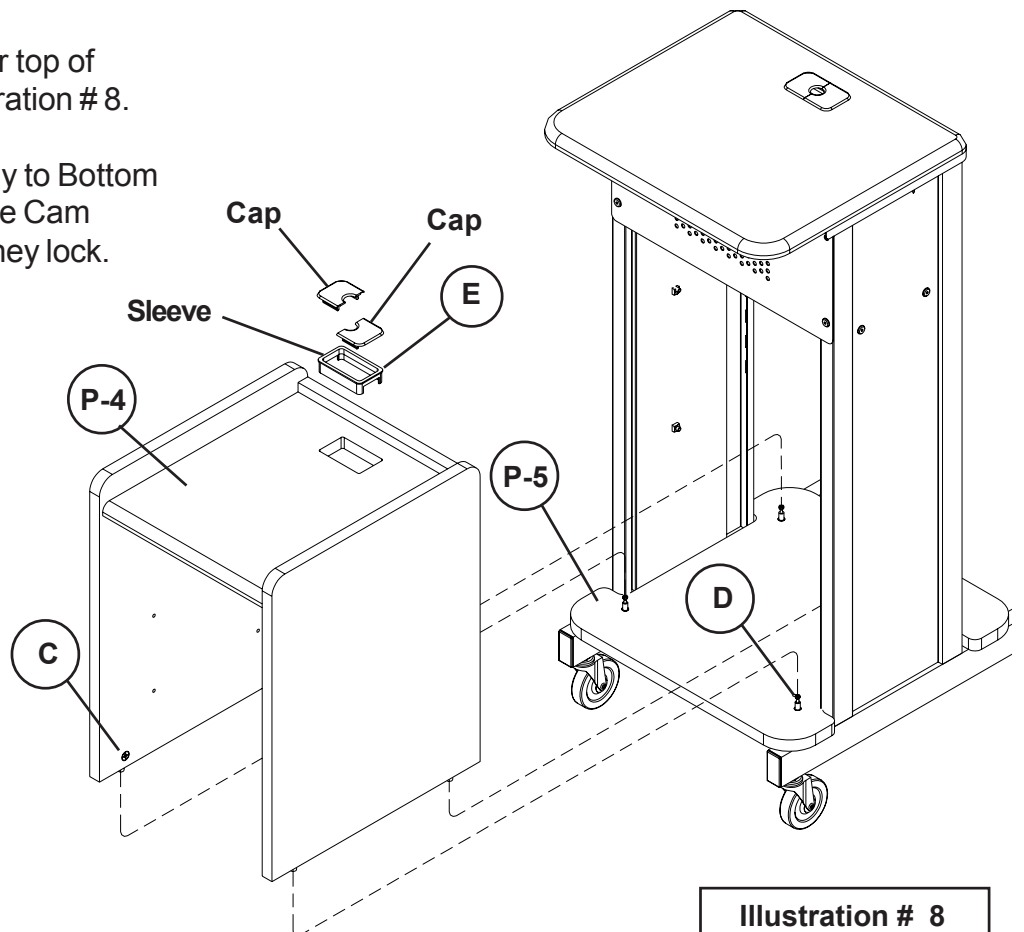

Illustration # 8

Illustration # 9

19. Place 6 Shelf Support Pins (B) in each of the two Side Panels (P-1 & P-2). Place Removable Shelves (P-7) on six Shelf Support Pins as shown in illustration #9.

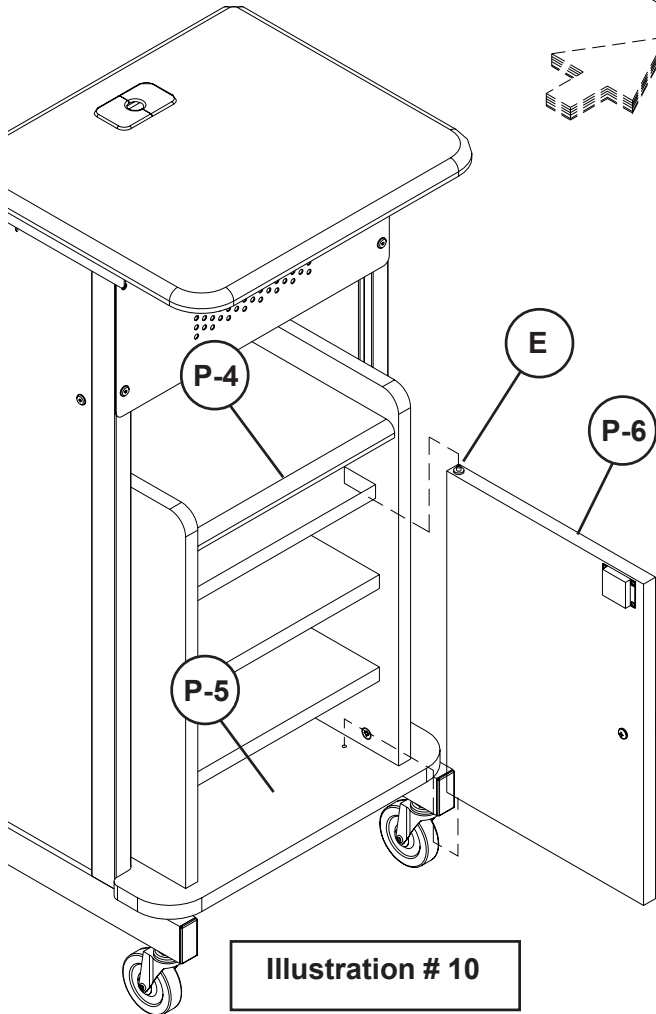
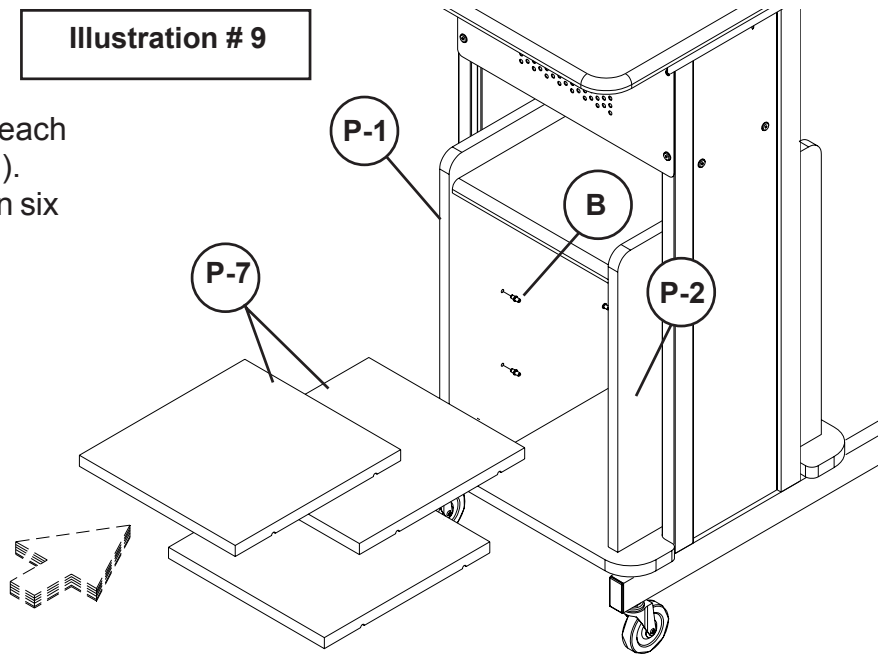

Illustration # 10

20. Insert the end of Spring Buttons (E) into the holes in Top Panel (P-4) and Bottom Platform (P-5) as shown in illustration # 10.

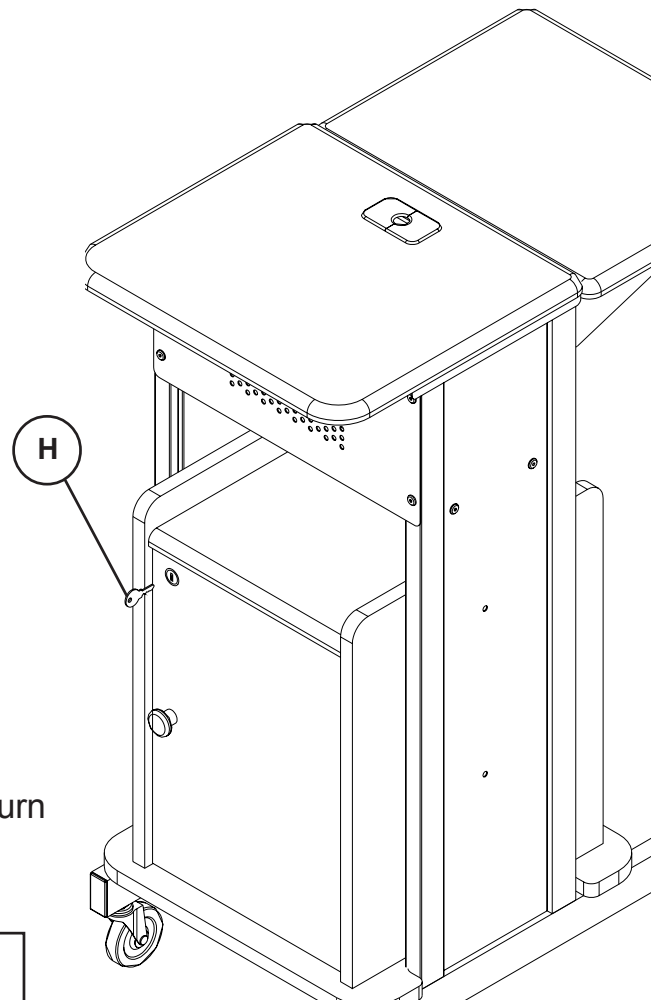

Illustration # 11

21. Insert Key (H) as shown in illustration # 11 and turn lock counter-clockwise to lock door.