

A black and white photograph showing a person's hand holding a Leica DISTO A2 laser distance meter. The device is partially tucked into a pocket of a tool bag. The background is blurred, suggesting an outdoor or construction site setting.

Leica DISTO™ A2

The original laser distance meter

- when it has to be **right**

Leica
Geosystems

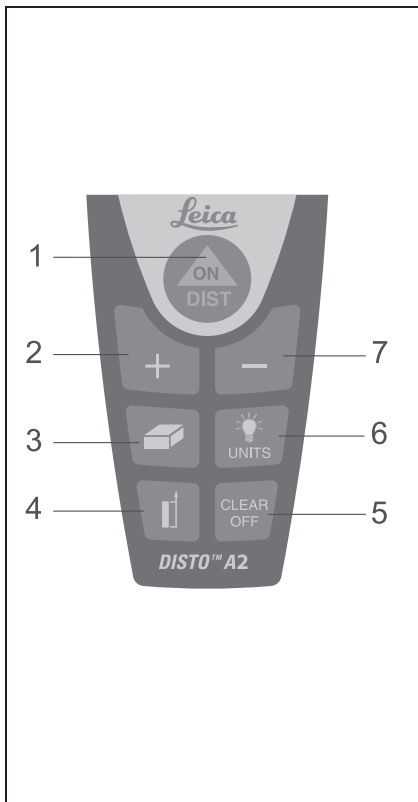
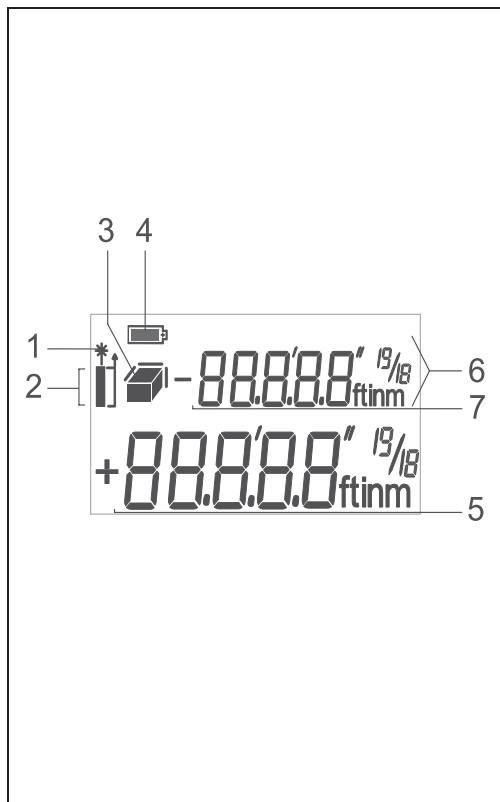
A**B**

User Manual

English

GB

Congratulations on your purchase of a Leica DISTO™.



The safety instructions can be found in a separate booklet, which accompanies this user manual.

The safety instructions along with the user manual should be read carefully before initial operation.

Overview

Keyboard

See drawing{A}:

- 1 **ON/DIST (ON/MEASUREMENT)** -key
- 2 **PLUS [+]** -key
- 3 **AREA/VOLUME** -key
- 4 **REFERENCE** -key
- 5 **CLEAR/OFF**-key
- 6 **UNITS/☀ (UNITS/ILLUMINATION)** -key
- 7 **MINUS [-]** -key

Display

See drawing {B}

- 1 Laser "ON"
- 2 Reference (front/rear)
- 3 Area/volume
- 4 Battery symbol

- 5 Main targets
- 6 Units with exponents (²/₃)
- 7 Second row (e.g. intermediate values)

Start up

Inserting / Replacing Batteries

Remove the battery cover, insert the battery correctly. Close the battery compartment. Replace the battery when this symbol  constantly blinks in the display.

- Only use alkaline batteries.
- Batteries should be removed due to danger of corrosion, if the device will not be used for a long time.

Selecting Units



Press this key until the desired unit is displayed.

Possible units:

Distance	Area	Volume
0.000 m	0.000 m ²	0.000 m ³
0.00 ft	0.00 ft ²	0.00 ft ³
0' 0" 1/16	0.00 ft ²	0.00 ft ³
0.0 in	0.00 ft ²	0.00 ft ³

Operation

Switching on/off



Device and laser are switched on.

The battery symbol is displayed until a key is pressed.



Holding down this key switches the device off.

The device also switches off automatically after three minutes of inactivity i.e. no key is pressed within that interval.

CLEAR-Key



The last action is cancelled

Within a function (area, volume, etc.) single measurements can be deleted step by step and re-measured.

Illumination



Switches the illumination on or off.

Reference Setting

Default reference setting is from the rear of the instrument.



The next measurement references the front of the instrument.

After one measurement, the reference returns automatically to the default setting (rear reference). See drawing {C}.

Measuring

Single Distance Measurement



Press to activate the laser. Press again to trigger the distance measurement.

The result is displayed immediately.

Continuous Measurement

This functions enables distances to be staked out. See drawing {D}.



Press and hold key down until a "beep" sound is heard.



Press key again briefly: continuous measurement is stopped.

The last measured value is displayed in the summary row.

Functions

Addition / Subtraction

Distance Measurement.



The next measurement is added to the previous one.



The next measurement is subtracted from the previous one.

Repeat this procedure for as many times as required. The result is always displayed in the summary row, the previous value is displayed in the second row.



The last operation is cancelled.

Area



Press this key once. This symbol  is displayed.



Press key and take the first measurement (e.g. length)



Press key again and take the second measurement (e.g. width)

The result is displayed in the main line.

Volume



Press this key twice. This symbol  is displayed.



Press key and take the first measurement (e.g. length)



Press key again and take the second measurement (e.g. width)

The area of the two values measured is displayed in the main line.









Press the key to take the third measurement (e.g. height). The value is displayed in the second line.

The resulting volume is displayed in the main line.

Staking out of constant distances

Constant distances can be entered for staking out purposes. The DISTO's display shows the to be staked out distance as well as multiples of the distance. As soon as the defined stake out distance is reached the DISTO beeps.

Inputting a stake out distance: Press and hold the  key, the auxiliary line will blink with crosslines. Change the value in the main line with  and  keys until the desired staking out distance is displayed. Holding the  and  down will speed up the adjustment.

By pressing the  key the staking out distance or multiples of it are displayed in the auxiliary line; the laser measuring starts. In the main line the distance between the staking out point (in the auxiliary line) and the DISTO (rear measuring reference) is displayed.

If the DISTO is moved along the staking out line, the displayed distance is reduced. At a distance of 0.1 m to the next staking out point the DISTO starts to beep. As soon as the staking out point is reached, the beep changes and the auxiliary line starts to blink. Repeat this procedure as often as needed.

The function is stopped by pushing the  key.

Appendix

Display Notices

All display notices are indicated by "InFo" or "Error". The following errors can be corrected.

InFo	Cause	Correction
252	Temperature too high	Let device cool down.
253	Temperature too low	Warm device up
255	Received signal too weak, time for a measurement too long.	Use a target plate
256	Received signal too strong	Use a target plate (gray side)
257	Faulty measurement, too much background light	Use a target plate (brown side)
Error	Cause	Correction
	Hardware error	If this message remains displayed after switching the device off and on several times, please contact our dealership.

Technical Specifications

Range (for extended distances, use a target plate)	0.05 m to 60 m (0.2 ft to 197 ft)
Measuring accuracy (2 σ)	typically: ± 1.5 mm (0.06 inch)*
Smallest unit displayed	1 mm
Laser class	II
Laser type	635 nm, < 1 mW
Automatic power off	after 180 s
Display illumination	✓
Continuous measurement	✓
Addition / subtraction	✓
Battery life, 9 V compound battery	up to 5000 measurements
Dimensions and weight	124x54x35 mm, 155 g
Temperature range: Storage	-25°C to +70°C (-13°F to +158°F)
Operation	-0°C to +40°C (+32°F to +104°F)

* in favourable conditions (optimal target surface, room temperature) up to 12 m. In unfavourable conditions, such as intensive sunshine, very weakly reflecting target surface or large temperature fluctuations, measuring accuracy may deteriorate to approx. ± 0.25 mm/m for distances above 12 m.

Measuring Conditions

Range

Range is limited to 60 m.

At night, at dusk or if the targets are shaded, the range increases without using a target plate. When ambient light is intense and the targets have poor reflecting properties, use a target plate!

Target Surfaces

Measuring errors can occur when measurements are made targetting colourless liquids (e.g. water), clear glass, polystyrene or similar semi-translucent surfaces, as well as from highly reflecting targets that deflect the laser.

Care

Clean with a soft, damp cloth. Never immerse the unit in water. Never use aggressive cleaning agents or solvents.

Warranty

The Leica DISTO™ A2 comes with a two year warranty from Leica Geosystems.

More detailed information can be found at:

www.disto.com

All right reserved for changes (drawings, descriptions and technical specifications).