

Tools and Hardware

Tools

Screwdriver, hammer, drift pin, phillips screwdriver

Hardware:

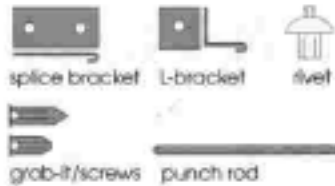

To Assemble

1 BASE UNIT. Place base unit in position on the floor.

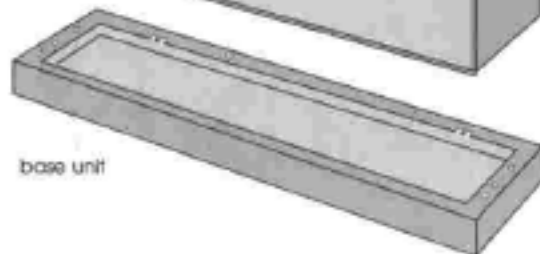
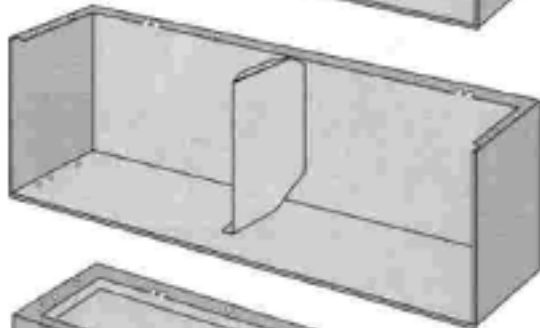
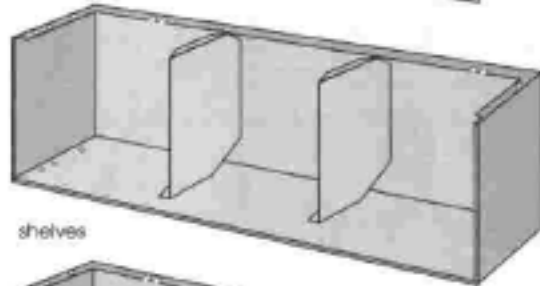

2 INTERCONNECT FILE SHELF W/BASE. To attach the first file shelf to the base unit, interconnect the two slots at the bottom of the shelf with the two nesting prongs on the base unit. It may be necessary to pry open the slots using the flat end of a screwdriver.

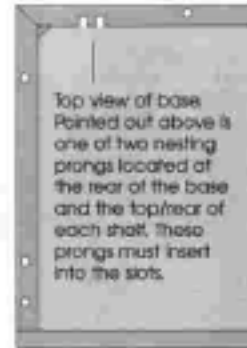
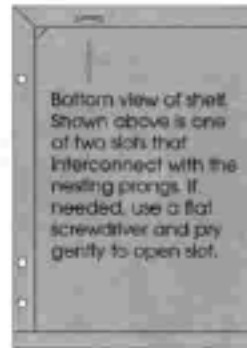

3 ATTACH RIVETS. Place silver rivets into all seven holes on the file shelf. Strike each rivet with a hammer until the small steel center of the rivet is flush with the aluminum crown of the rivet.



To aid alignment, interconnect parts and insert a small screwdriver (not provided) into the holes and pry gently until a rivet can be inserted.

4 ADD FILE SHELVES. When adding file shelves, it is important to always begin by INTERCONNECTING THE NESTING PRONGS AND SLOTS at the rear of each shelf before inserting the rivets.

5 SPACERS AND WORK SHELVES. If using spacers or work shelves, place the spacer or work shelf at the desired level. If a work shelf is used, pull the shelf out approximately half way and place a rivet in the rear hole. Anchor the rivet by using the punch rod provided and a hammer. Pull the shelf out as far as it will go and complete riveting.

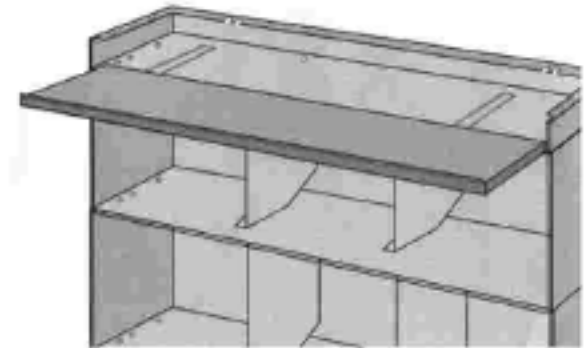

6 SECURE CABINETS TO WALL. If cabinets are placed side-to-side, each cabinet must be attached to the wall for safety. Use the L-bracket and the proper grab-it for either drywall or concrete block. Install the L-bracket in the center of the top shelf. DO NOT ADD TOP PANEL YET. You must attach the cabinets side-to-side with the splice brackets provided.

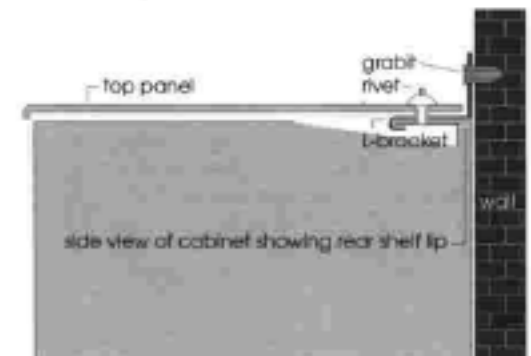

Bindertek® Systems

Organizational Solutions For Every Office

800-456-3453 www.bindertek.com

7 SPLICE BRACKETS. You can place cabinets side-to-side and/or back-to-back by using the splice brackets provided. After brackets are in place, attach with rivets.

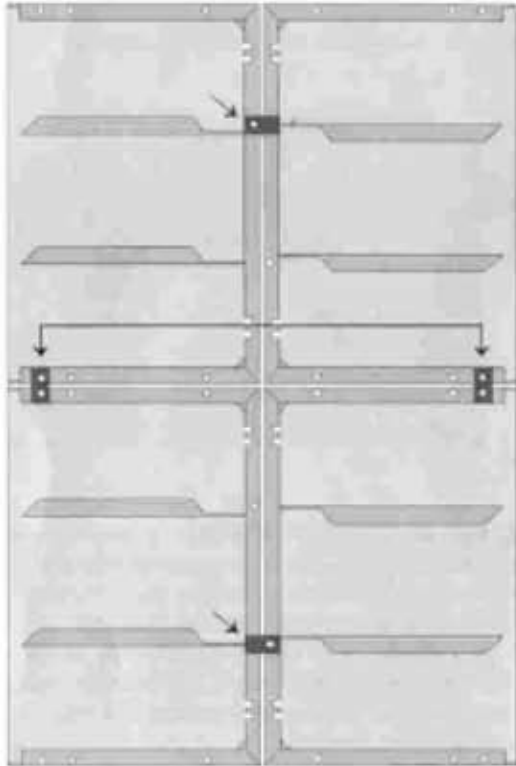

Top view of file shelves. Attachment side-to-side and back-to-back.

If the cabinets are placed side-to-side, use the splice brackets to join the row of cabinets together. Again, with side-to-side configurations, EACH CABINET MUST BE ATTACHED TO A WALL, as shown in step 6.

8 ATTACHING THE TOP. Set the top on the last file shelf installed. A standard steel top attaches by first inserting a rivet through the top panel, L-bracket and shelf lip. Secure the top with the remaining six rivets. If using a PLASTIC TOP, attach underneath with the black allen screws and wrench provided.

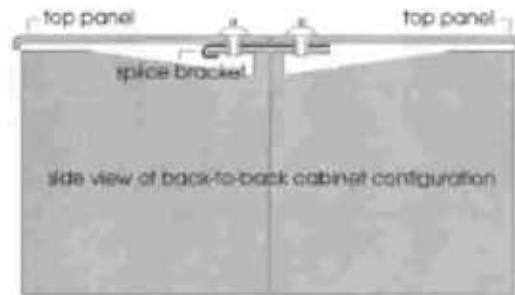

Adding to an Assembled Cabinet

When installing a file shelf to an assembled cabinet, unload the necessary file shelves and remove the top and upper shelves if desired.

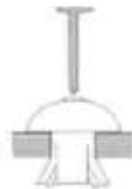

To remove existing rivets, use a nail (not provided) and punch the center pin completely through the rivet. Use a screwdriver to pry out the rivet. Refer to prior assembly steps to finish installation.

Add-On to your Flex-Stax Unit Today!

Flex-Stax™

Combine Shelves for Binders and File Folders

Flex-Stax are highly efficient modular shelving units constructed of 18-gauge furniture steel, finished in long-lasting neutral gray or beige enamel. Mix shelving for binders and file folders. Add a convenient pull-out work shelf. Modify the configuration or add modules as your needs change.

Each 36-inch shelf holds 12 Standard or 16 Slim letter-size binders, or 36 inches of file folders. For each shelving unit, you will need one Top and Base Unit. Order today and maximize the use of your valuable office space.

Flex-Stax	H x W x D	Item #	Price
Shelf Tier for Binders	12" x 36" x 12"	1700-58	135.00 (10.00*)
Shelf Tier for File Folders	10" x 36" x 12"	1700	105.00 (10.00*)
Top & Base Unit	2" x 36" x 12"	1700-50	95.00 (5.00*)
Spacer & Work Shelf	2" x 36" x 12"	1700-51	245.00 (5.00*)
Spacer*	2" x 36" x 12"	1700-52	78.00 (5.00*)

Assembly required. Additional freight charges apply as noted in parentheses. This unit will not accommodate legal size (14") binders. Please allow 3-4 weeks for delivery.

**Required only to equalize height of side-by-side units where one unit contains a work shelf and others do not.*

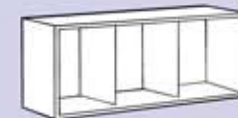

Shelf tier for binders
(Shown with Top Unit)



Spacer and pull-out work shelf

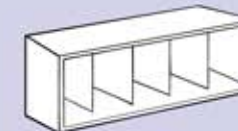

Shelf tier for letter-size file folders
(Shown with Top Unit)

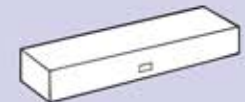

Sturdy 18-gauge furniture steel base