

# IMPORTANT INFORMATION ENCLOSED

**CONTAINS:  
YOUR OWNER'S MANUAL  
WARRANTY ACTIVATIONS CARD  
YOUR WARRANTY CERTIFICATE**

**Paramount**<sup>TM</sup>  
POOL & SPA SYSTEMS

"We make pool care automatic."

004-027-8742-00

REV DATE 2/04

**Paramount**<sup>TM</sup>  
POOL & SPA SYSTEMS

"We make pool care automatic."

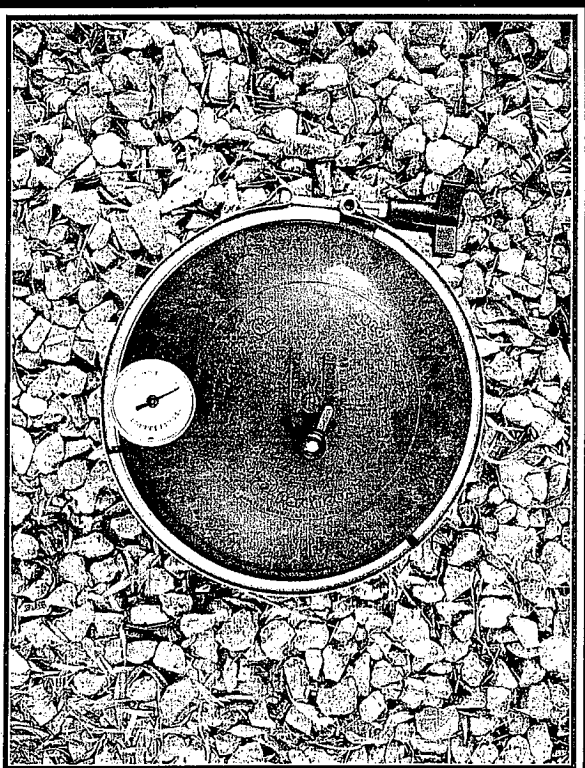

**WATER VALVE  
OWNER'S MANUAL**

9025 S. Kyrene Rd, Ste. 107, Tempe, AZ 85284

1.800.621.5886 • [www.paramountpoolproducts.com](http://www.paramountpoolproducts.com)

PAR0292

## Table of Contents

Congratulations! .....	3
What You Need to Know .....	3
What is a Water Valve? .....	4
Keys to Clean and Healthy Water .....	6
Warranty .....	8
Water Valve Instructions .....	11
How to Open the Water Valve .....	11
How to Close the Water Valve .....	11
Module Installation .....	11
Pool Troubleshooting Guide .....	12
Pool Information .....	15
Notes .....	15

## Pool Information:

Your Pool Builder will provide the below information upon request:

Pool Builder: \_\_\_\_\_  
Pool Start-up Date: \_\_\_\_\_  
Filter Pressure (After Backwash): \_\_\_\_\_  
Water Valve Pressure (After Backwash): \_\_\_\_\_  
Backwash Filter When Pressure Reaches: \_\_\_\_\_  
Gallons of Water in Pool: \_\_\_\_\_  
Gallons of Water in Spa: \_\_\_\_\_

## Notes:

---

---

---

---

---

---

---

---

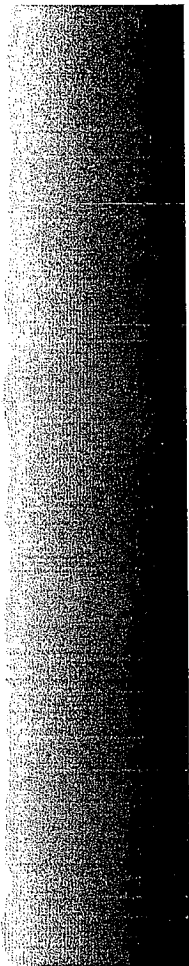

### **One set of nozzles stay up whenever the pump is on.**

One set of nozzles stay up all the time, even though the other sets cycle up and down.

- A part inside the module has a problem
  - Debris is holding one piston open all the time. Remove the debris.
  - Piston diaphragm is broken. Replace the module.

### **All nozzles are floating when the pump is on.**

When all nozzles are floating, or have water running through them all at the same time, check the module.

- Module is missing. Replace the module.
- Module is damaged and all pistons are open. Replace the module.
- Module is not seated properly. Remove module, remove any debris found inside the base and on the module, reinstall the module.

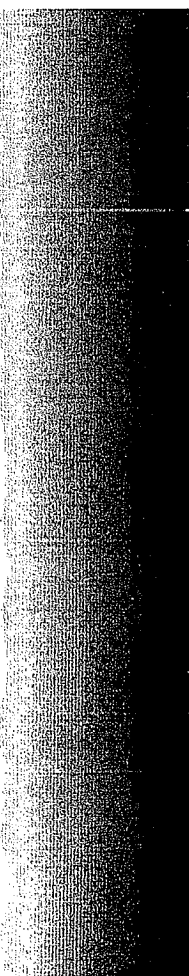

## **Congratulations!**

Paramount Pool & Spa Systems would like to thank you for your purchase. We design our products with you in mind and our goal is to make pool ownership more affordable and as carefree as possible.

### **What You Need to Know**

Nothing, really! The Paramount Pool & Spa Systems Water Valve is fully automatic and operates whenever the pump is running.

However, if you are interested and want to learn more, read the next two sections; **What is the Water Valve and Keys to Clean and Healthy Water.**

In the unlikely event that you have a problem with your new Water Valve, Check the Pool Trouble Shooting section. Unexpected things sometimes happen but are usually simple to correct.

## What is a Water Valve?

The Water Valve is a control valve that automatically distributes water to all areas of your pool and spa. Much like how an automatic sprinkler system turns water on and off in different areas of your yard.

The Water Valve automatically distributes water through a network of spray nozzles located throughout the pool. These nozzles or “returns” as they are often called, return water from the pump and filter back into the pool.

### Paramount Pool & Spa

Systems manufacturers several Water Valve designs and you will have one or more depending on the size and type of pool and/or spa you purchased.

The most common design is the Six-Port Valve which has six outlet pipes, fed by a single inlet pipe in the bottom center of the valve.

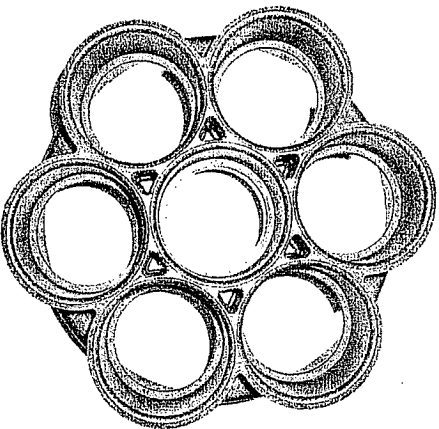

### Nozzle pops up and down, but does not rotate.

- When the nozzle is up, try pushing on it with a pool pole. This may dislodge debris.
- Remove the nozzle, rinse to remove all debris.
- Replace if damaged (Read *Lifetime Limited Warranty*). Nozzles have a lifetime warranty to the original pool owner.

### Clean Area Around One Zone Only

When one set of nozzles comes on with the pump each day, but never rotates more than once a day, the Water Valve is not cycling.

- “Pause” Mode may be active. Turn the knob on top of the Water Valve to “Run”.
- The turbine may be jammed with debris. Open the Water Valve, remove the Module (see page 11), and inspect the turbine.
  - Look for debris.
  - Does the turbine move freely? If yes, the debris may be in the pipe out of sight. Turn on the pump for a few seconds to clear the line.
- Does turning the turbine turn the gears? If not, replace the module.

## Pool Troubleshooting Guide

Here you will find the most common information needed for troubleshooting your pool. Also, additional information is available on our website at [www.ParamountPoolProducts.com](http://www.ParamountPoolProducts.com).

### The system doesn't clean like it used to.

If the nozzles are turning on and off in groups, but don't clean as far as they once did, then the in-floor system isn't getting enough water to run effectively. A quick way to check this is by looking at the pressure gauge: is it below 14 psi?

- Service the filtration system, clean all baskets, and backwash the filter.
- Make sure auxiliary valves, spa jets, waterfalls, and manual surface returns are not open when the pool is in its cleaning mode.

### Dirt Collects around one nozzle and/or nozzle stays up all the time.

When a nozzle stays up even when the pump is off, something is stuck in it. Try the following steps one at a time until the problem is solved:

- Push the nozzle down with a pool pole.
- Remove the nozzle and rinse to remove all debris.

Replace the nozzle if it is damaged (Read *Lifetime Limited Warranty*).

Nozzles are covered for life, to the original pool owner.

## What is a Water Valve? (continued)

Another type of valve is the Two-Port Control or Circulation Valve, which has two "high-flow" outlet ports. This design is most often used to alternate the water supply between two Six-Port Valves and is usually found on very large pools.

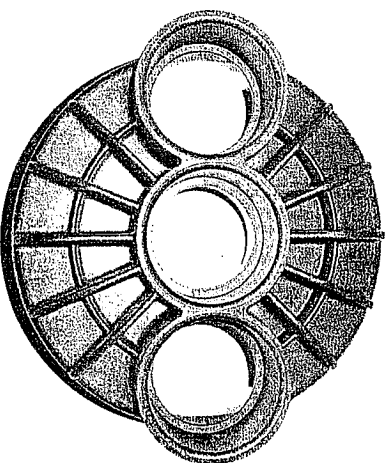

All versions are water powered and non-electric. Water passing through the inlet-port turns a turbine, which drives the internal time and valve actuators. This innovative and patented valve doesn't need electricity when the pump is on it runs automatically.

You're in control. If you choose, you can pause the Water Valve on any return point, allowing maximum deep heating, or more surface action. The choice is yours, but most people like how it takes care of itself so you don't even have to think about it.

## Keys to Clean and Healthy Water

Paramount Pool & Spa Systems' Water Valve is the key to clean and healthy water. Dirt is a problem that needs quick removal.

The Water Valve makes it possible for your pump to blast all areas of the pool with a strong jet of water, which is needed to distribute chemicals and heat and to keep the pool surface clean and healthy.

Traditional pool design uses an old fashion method of returning filtered water back to the pool through wall inlets near the surface of the water. This is better than nothing, but returns don't put the heated and purified water on the bottom where it is really needed. Worst of all, by returning heat and chemicals near the surface, the wind and sun can quickly steal them from the water.

In contrast, a pool equipped with a state-of-the-art, Paramount Pool & Spa Systems' Water Valve returns fresh water to the floor of the pool where it can quickly kill algae and bacteria before it grows. The same powerful jets of water that will clean your pool, efficiently distribute warm, purified water throughout the pool, so the pool is ready to enjoy when you are.

## Water Valve Instructions

### How to Open the Water Valve

1. TURN OFF THE PUMP.
2. To remove the Band Clamp, turn the Clamp Knob counter-clockwise until it comes off the bolt. Note: You may have a 7/16" Nut instead of a Clamp Knob. If this is the case, use a wrench to remove it.
3. Lift the top off the base.

### How to Close the Water Valve

1. Check the O-Ring (or square gasket) and groove for debris, which could prevent a good seal. Remove any debris found and verify the O-Ring is in the groove properly.
2. Place the top on the base. You may face it any direction you like.
3. Place the Band Clamp around the Valve Shells and put the Clamp Knob or 7/16" nut on the bolt.
4. Tighten the Band Clamp securely. Note: Tapping the Band Clamp gently around the circle will help you tighten the bolt with less effort.
5. Turn on the pump and inspect the Water Valve for any drips. If you find drips, turn off the pump and tighten the Band Clamp more. Note: Silicone lubricant makes O-Rings seal more effectively, but is rarely needed. NEVER use petroleum jelly on plastic or rubber.

### Module Installation

1. TURN OFF THE PUMP.
2. Open the Water Valve.
3. Lift the Module out of the Base. Note: The Module is designed to seal inside the Base so it may be difficult to lift. An easy solution is to turn the pump on and off quickly. CAUTION: Make sure no one is standing nearby or that person could get wet when the Module pops out of the Base.
4. Install the Module by aligning the pins on the bottom with the little holes in the Base.
5. Close the Water Valve.

## Part Number Diagrams

Top Complete (black): 005-302-4300-03

Top Complete (almond): 005-302-4300-60

(Includes top gauge, and pause assembly)

Knob/Pawl Assembly: 005-302-3502-00

Module, 6-Port: 004-302-4408-00

Module, 2-Port (Control): 004-302-4402-00

Module, 2-Port (Circulation): 004-302-4400-00

Module, 4-Port (9-Port Systems): 004-302-4406-00

Band Clamp Complete: 005-302-3570-00  
(Includes clamp and clamp knob)

Band Clamp Knob Only: 005-302-3600-00

Band Clamp Nut Only: 005-302-0640-00

Valve O-Ring Only: 005-302-0100-00

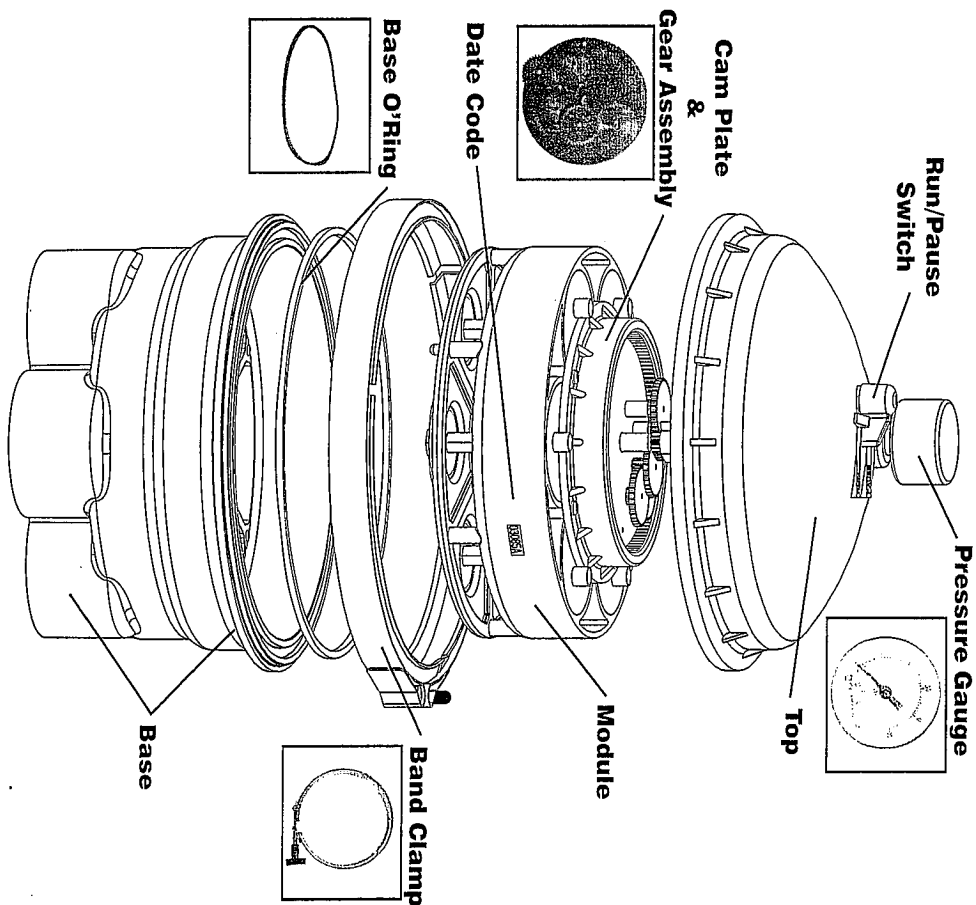
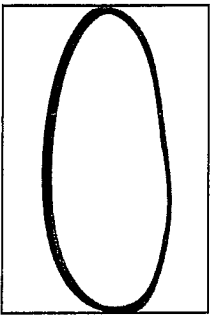
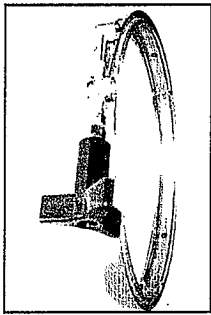
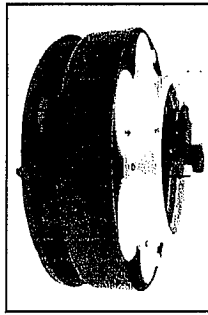
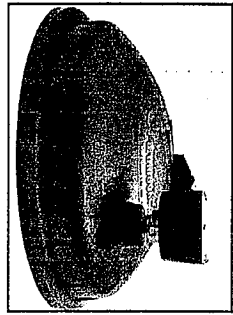

Paramount Pool & Spa Systems (PP&SS)  
9025 South Kyrene Road, Suite 107  
Tempe, AZ 85284  
www.paramountpoolproducts.com



### 3-YEAR WARRANTY

U.S. Patents: 3,521,304 • 3,675,252 • 4,188,673 •  
4,212,088 • 4,391,005 • 4,939,797 • 5,135,579 •  
5,251,343 • 5,265,631 • 6,301,723 • 6,367,098 •  
6,393,629 • 6,393,699 • other patents pending

#### I. Paramount Water Valve

A. Paramount water valve module and housing are warranted for a period of 3 years to be free of manufacturing defects including wear and tear on product from date of pool start-up. Replacement parts thereafter are warranted for a period of 1 year. *This warranty applies to the original pool owner only.*

#### II. Transferability & Conditions

A. This 3-year warranty is extended to the original pool owner when the products covered in this warranty have been installed by an authorized Paramount dealer according to the manufacturer's specification.  
B. Paramount Pool & Spa Systems shall not be liable for incidental or consequential damages related to products or installation for any reason.

#### III. Return Procedures

A. Affected parts only should be removed, then call Paramount Pool & Spa Systems Customer Care at 800-621-5886 for a Return Goods Authorization (RGA) number.  
B. Package and ship affected parts to Paramount Pool & Spa Systems, along with the your name, address and phone number.  
C. It is the responsibility of the pool owner to remove the Paramount Pool & Spa Systems manufactured part including water valve module, top or bottom of the water valve housing, or other Paramount components as described within this warranty.  
D. Affected part in question must be shipped freight pre-paid to Paramount Pool & Spa Systems, Inc., 9025 S. Kyrene, Suite 107, Tempe, Arizona, 85284.

E. Paramount Pool & Spa Systems will repair or replace the warranted product at no charge to the original pool owner. The repaired or replaced product or related part will be returned to the original pool owner, C.O.D. Freight collect. The reinstallation of the replacement or repaired product or part is the responsibility of the pool owner.

#### Your Rights May Vary

A. Some states do not allow limitation on how long an implied warranty lasts, so these limitations may not apply to you.  
B. This warranty gives you specific legal rights, and you may also have other rights which may vary from state to state.

In compliance with the Magnuson-Moss Warranty-Federal Trade Commission Act (Public Law 93-637), Paramount Leisure Industries, Inc. dba Paramount Pool & Spa Systems (PP&SS), provides this limited warranty.

#### CONDITIONS

This limited warranty shall be subject to the original owner complying with the following conditions:  
1. Product Registration Form must be returned to Paramount within 30 days of pool completion,  
2. The swimming pool shall be kept full of water at all times except for purposes of repair or maintenance not to exceed five (5) days.  
3. The PP&SS system shall be operated by the original owner with reasonable care and necessary maintenance.

#### LIMITATIONS

No warranty extends to any part of the PP&SS parts or components which is caused by any of the following conditions or events:  
1. Defects or failure caused by abuse, lack of responsible care, lack of necessary maintenance, improper operation, vandalism, acts of God.

2. Damages or failures caused by substitution or addition of equipment or service not expressly authorized which affect the operation or designed use of the PP&SS parts or components, or other related system components distribute or supplied by PP&SS covered under this warranty.  
3. PP&SS expressly denies any responsibility or liability for incidental or consequential damages arising out of, or as a result of, use or ownership of your PP&SS parts or components, or other related products covered under this warranty.  
4. Any defects caused by acts of God, such as storms, earth quakes, ground movement, or freezing, etc., that are beyond normal conditions.  
5. Installation of PP&SS System by a non-authorized installer may render this warranty null and void.  
Some states do not allow the exclusion or limitation of incidental or consequential damages, so the above limitations or exclusions may not apply to you.

Implied warranties are limited in duration to the duration of the written limited warranty here within. Some states do not allow limitations on how long an implied warranty lasts, so the above limitations may not apply to you.

This warranty gives you specific legal rights, and you may also have other rights which may vary from state to state.