



Cisco Unified IP Video Phone 7985G





INCLUDING LICENSE AND WARRANTY

Corporate Headquarters

Cisco Systems, Inc.
170 West Tasman Drive
San Jose, CA 95134-1706
USA
<http://www.cisco.com>
Tel: 408 526-4000
800 553-NETS (6387)
Fax: 408 526-4100



Common Phone Tasks

View online help on the phone	Press  .
Place a call	Go-off hook before or after dialing a number.
Redial a number	Press Redial . Or press the Navigation button while on-hook to see your Placed Calls log.
Switch to the handset during a call	Pick up the handset.
Switch to the speaker or headset during a call	Press  or  , then hang up the handset.
Mute your phone	Press  .
Use your call logs	Press  to choose a call log. To dial, highlight a listing and go off-hook.
Edit a number	Press EditDial , << or >>.
Hold/resume a call	Press Hold or Resume .
Transfer a call to a new number	Press Transfer , enter the number, then press Transfer again.
Start a standard conference call	Press more > Confmn , dial the participant, then press Confmn again.



Cisco, Cisco IOS, Cisco Systems, and the Cisco Systems logo are registered trademarks of Cisco Systems, Inc. or its affiliates in the United States and certain other countries. All other brands, names, or trademarks mentioned in this document or Website are the property of their respective owners. The use of the word partner does not imply a partnership relationship between Cisco and any other company. (0501R)

© 2006 Cisco Systems, Inc. All rights reserved.

78-16798-02



Cisco Unified IP Video Phone 7985G for Cisco CallManager 4.2

















Phone Screen Icons
Button Icons
Common Phone Tasks



Softkey Definitions

AbbrDial	Dial using a speed dial index number
Answer	Answer a call
Back	Return to the previous Help topic
Barge	Add yourself to a call on a shared line
CallBack	Receive notification when a busy extension becomes available
Cancel	Cancel an action or exit a screen without applying changes
cBarge	Add yourself to a call on a shared line and establish a conference
CFwdALL	Setup/cancel call forwarding
Clear	Delete records or settings
Close	Close the current window
ConfList	View conference participants
Confmn	Create a conference call
Delete	Remove characters to the right of the cursor when using EditDial
Details	Open the Details record for a multiparty call in the Missed Calls and Received Calls logs
Dial	Dial a phone number
DirTrfr	Transfer two calls to each other
EditDial	Edit a number in a call log
EndCall	Disconnect the current call
Erase	Reset settings to their defaults
Exit	Return to the previous screen
GPickUp	Answer a call ringing in another group









HLog	Prevent hunt group calls from ringing on your phone by logging out of hunt groups
iDivert	Send a call to your voice messaging system
Join	Join several calls already on a single line to create a conference
MeetMe	Host a Meet-Me conference call
more	Display additional softkeys
New Call	Make a new call
OPickUp	Answer a call ringing in an associated group
Park	Store a call using Call Park
PickUp	Answer a call in your group
QRT	Submit call problems to the system administrator
Redial	Redial the most recently dialed number
Remove	Remove a conference participant
Resume	Resume a call on hold
RmLstC	Drop the last party added to a conference call
Save	Save the chosen settings
Search	Search for a directory listing
Select	Select a menu item or call
Transfer	Transfer a call
Update	Refresh content
VidMode	Choose a video display mode
<<	Delete entered characters
>>	Move through entered characters

Phone Screen Icons

Line and Call States	
	Call Forwarding enabled
	Call on hold
	Connected call
	Incoming call
	Off-hook
	On-hook
	Shared line in use
Critical Calls	
	Priority call
	Medium priority call
	High priority call
	Highest priority call
Selected Device	
	Handset in use
	Headset in use
	Speakerphone in use
Other Features	
	Speed-dial button configured
	Message waiting

	Option selected
	Phone service URL assigned

Button Icons

	Messages
	Services
	Help
	Directories
	Settings
	Speaker
	Mute
	Headset



Contents

Getting Started 1

- Using this Guide 1
- Safety and Performance Information 3
- Accessibility 5

Connecting Your Video Phone 6

An Overview of Your Video Phone 8

- Understanding Buttons and Hardware 8
- Understanding the Screen Layout 12
- Getting Help on Your Phone 14
- Understanding Feature Functionality and Availability 18

Basic Call Handling 19

- Before You Make a Video Call 19
- Placing a Video Call 19
- Answering a Video Call 21
- Ending a Video Call 22
- Placing a Telephone Call 22
- Using Hold and Resume 22
- Displaying Your Outgoing Video Picture 23
- Muting Video or Audio 23
- Transferring Calls 24
- Forwarding Your Calls to Another Number 25
- Making Conference Calls 26

Advanced Call Handling 29

- Speed dialing 29

Picking Up a Ringing Call to Your Phone	30
Storing and Retrieving Parked Calls	34
Tracing Suspicious Calls	34
Prioritizing Critical Calls	34
Using a Headset, and Speakerphone	36
Obtaining a Headset	36
Using AutoAnswer with a Headset or the Speakerphone	37
Using Phone Settings	38
Adjusting the Volume	38
Customizing Alert Tone	39
Adjusting Monitor Brightness	39
Adjusting Camera Brightness, Hue and Saturation	39
Using Call Logs and Directories	40
Using Call Logs	40
Using Corporate Directory on Your Phone	42
Accessing Voice Messages	43
Accessing Your User Options Web Pages	44
Logging In to the User Options Web Pages	44
Subscribing to Phone Services	45
Understanding Additional Configuration Options	46
Troubleshooting Your Video Phone	48
General Troubleshooting	48
Viewing Phone Administration Data	49
Using the Quality Reporting Tool	49
Cisco One-Year Limited Hardware Warranty Terms	50
Index	52



Getting Started

Using this Guide

This guide provides you with an overview of the features that are available on your phone. You can read the guide completely for a solid understanding of your phone's capabilities, or refer to the following table for pointers to commonly used sections.

If you want to...	Then
Explore your video phone on your own	Press  (Help button) on the phone when you need assistance.
Review safety information	See the “Safety and Performance Information” section on page 3.
Use your video phone after it is installed	Start with the “An Overview of Your Video Phone” section on page 8.
Connect your video phone	See the “Connecting Your Video Phone” section on page 6.
Learn what the buttons mean	See the “Understanding Buttons and Hardware” section on page 8.
Learn about the screen	See the “Understanding the Screen Layout” section on page 12.
Make calls	See the “Placing a Video Call” section on page 19.
Put calls on hold	See the “Using Hold and Resume” section on page 22.
Mute calls	See the “Muting Video or Audio” section on page 23.
Transfer calls	See the “Transferring Calls” section on page 24.
Make conference calls	See the “Making Conference Calls” section on page 26.
Share a number	See the “Using a Shared Line” section on page 31.
Use your video phone as a speakerphone	See the “Using a Headset, and Speakerphone” section on page 36.
Change the ringer or call volume	See the “Adjusting the Volume” section on page 38.
Choose a different ring sound	See the “Customizing Alert Tone” section on page 39.
Customize the brightness of your screen	See the “Adjusting Monitor Brightness” section on page 39.

Finding Additional Information

You can access the most current Cisco Unified IP Phone documentation on the World Wide Web at this URL:

http://www.cisco.com/univercd/cc/td/doc/product/voice/c_ipphon/index.htm

You can access the Cisco website at this URL:

<http://www.cisco.com/>

International Cisco websites can be accessed from this URL:

http://www.cisco.com/public/countries_languages.shtml

More Information about Customizing Your Phone on the Web

Your Cisco Unified IP Phone is a network device that can share information with other network devices in your company, including your computer. You can use your Cisco CallManager User Options web pages to establish and customize phone services and to control phone features and settings from your computer. This guide provides a brief overview of these capabilities. For complete instructions, refer to *Customizing Your Cisco Unified IP Phone on the Web* at the following URL:

http://www.cisco.com/univercd/cc/td/doc/product/voice/c_ipphon/index.htm

Safety and Performance Information

Installing and Using Your Video Phone

Read the following safety notices before installing or using your Cisco Unified IP Video Phone:



Warning

IMPORTANT SAFETY INSTRUCTIONS

This warning symbol means danger. You are in a situation that could cause bodily injury. Before you work on any equipment, be aware of the hazards involved with electrical circuitry and be familiar with standard practices for preventing accidents. Use the statement number provided at the end of each warning to locate its translation in the translated safety warnings that accompanied this device.

SAVE THESE INSTRUCTIONS



Warning

Read the installation instructions before you connect the system to its power source.



Warning

Ultimate disposal of this product should be handled according to all national laws and regulations.



Warning

Do not work on the system or connect or disconnect cables during periods of lightning activity.



Warning

To avoid electric shock, do not connect safety extra low voltage (SELV) circuits to telephone network voltage (TNV) circuits. LAN ports contain SELV circuits, and WAN ports contain TNV circuits. Some LAN and WAN ports use RJ-45 connectors. Use caution when connecting cables.



Warning

Telephone receivers produce a magnetic field that can attract small magnetic objects such as pins and staples. To avoid the possibility of injury, do not place the handset where such objects may be picked up.

Using an External Power Supply

The following warnings apply when you use the external power supply with the Cisco Unified IP Video Phone 7985G:



Warning

This product relies on the building's installation for short-circuit (over current) protection. Ensure that a fuse or circuit breaker no larger than 120 VAC, 15A U.S. (240 VAC, 10A international) is used on the phase conductors (all current-carrying conductors).



Warning

The device is designed to work with TN power systems.



Warning

The plug-socket combination must be accessible at all times because it serves as the main disconnecting device.



Caution

Only use the Cisco specified power supply with this product.

Using External Devices with Your Cisco Unified IP Video Phone

The following information applies when you use external devices with the Cisco Unified IP Video Phone:

Cisco recommends the use of good quality external devices (such as headsets) that are screened against unwanted radio frequency (RF) and audio frequency (AF) signals.

Depending on the quality of these devices and their proximity to other devices such as mobile phones or two-way radios, some audio noise may still occur. In these cases, Cisco recommends that you take one or more of the following actions:

- Move the external device away from the source of the RF or AF signals.
- Route the external device cables away from the source of the RF or AF signals.
- Use screened cables for the external device, or use cables with a better screen and connector.
- Shorten the length of the external device cable.
- Apply ferrites or other such devices on the cables for the external device.

Cisco cannot guarantee the performance of the system because Cisco has no control over the quality of external devices, cables, and connectors. The system will perform adequately when suitable devices are attached by using good quality cables and connectors.



Caution

In European Union countries, use **only** external headsets that are fully compliant with the EMC Directive [89/336/EC].

Accessibility

A list of accessibility features is available upon request.

Connecting Your Video Phone

Your system administrator will likely connect your new Cisco Unified IP Video Phone 7985G to the corporate IP network. If that is not the case, refer to the graphic and table below to connect your phone.

Cisco Unified IP Video Phone 7985G Cable Connections

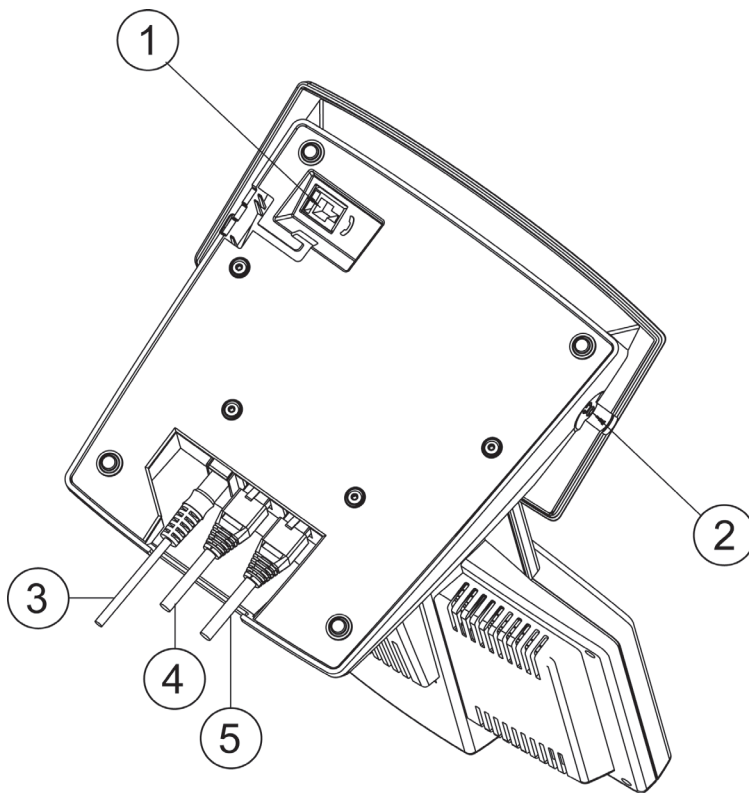

1	Plug for handset	4	Network cable, SW port (10/100 SW)
2	Plug for headset	5	Network cable, PC port (10/100 PC)
3	Power cable, 48V DC		

Mounting the Handset Bracket

-
- Step 1** Slide the handset bracket into the tracks as shown on the figure. Make sure to push it firmly into the tracks until it snaps into place.
- Step 2** Connect the handset cable at the underside of the video phone.
- Step 3** Place the system in an upright position and lay the handset in its place. The handset is held in place by magnets.
-

Cisco Unified IP Video Phone 7985G Handset Bracket

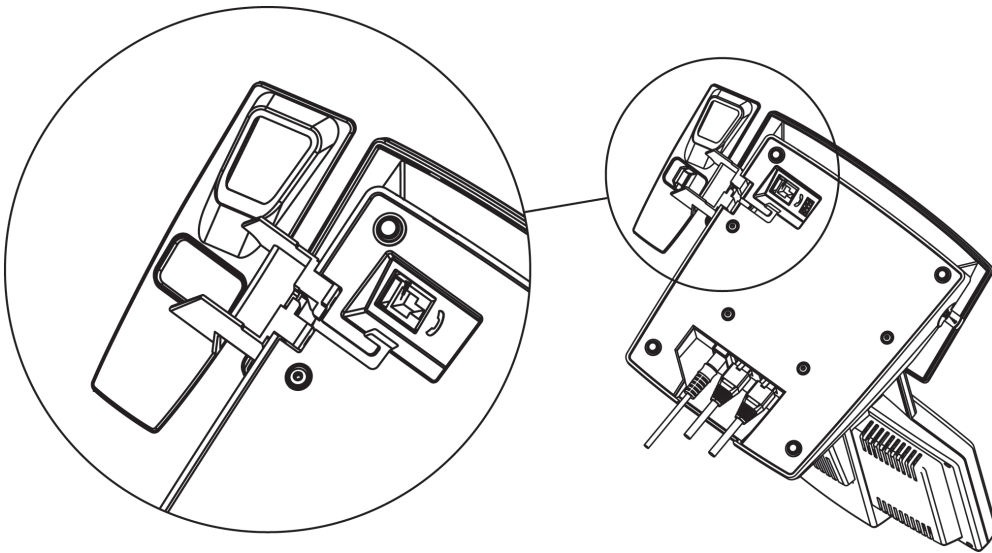

An Overview of Your Video Phone

Your Cisco Unified IP Video Phone 7985G provides business-quality video over the same data network that your computer uses. Because the 7985G is designed for the individual workspace, it makes a video meeting as simple as a telephone call. The video phone includes the same softkey functionality and features as a Cisco Unified IP Phone, allowing you to place and receive calls, put calls on hold, transfer calls, make conference calls, and so on with the advantage of being able to see callers using video phones.

Design features:

- All-in-one system designed for personal video in any workspace
- Integrated 8.4" LCD
- Ergonomically correct camera and screen position
- Integrated keypad for both voice and video calls
- Softkeys for easy control of the video phone
- Handset, speakerphone, and headset jack
- Access to network data and services
- Online control from your User Options web pages—Customize your phone's features by using a web browser on your computer
- A comprehensive online help system—Obtain helpful tips, descriptions, and procedures directly from your phone

The sections that follow provide you with an overview of your video phone and tips for interacting with it. Even if you have used other Cisco Unified IP Phones, you will find it useful to review this information to learn about the new features that are offered on the Cisco Unified IP Video Phone 7985G.

Understanding Buttons and Hardware

Your Cisco Unified IP Video Phone 7985G includes the following hardware features:

- Speakerphone or headset mode support
- Five softkey buttons for access to telephony features
- Four feature buttons to provide easy access to messages, directories, services, and settings
- One-button access to built-in online help
- Video-specific buttons—Display, Brightness, Selfview and Picture in Picture (PiP)

- Button for displaying the lines of the video phone

Refer to the following graphics and table for detailed descriptions.

Cisco Unified IP Video Phone 7985G Overview

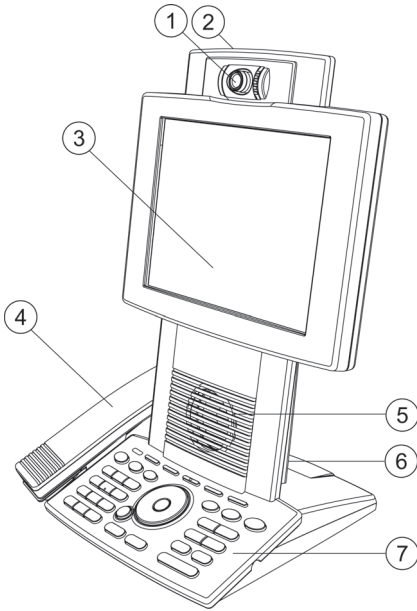







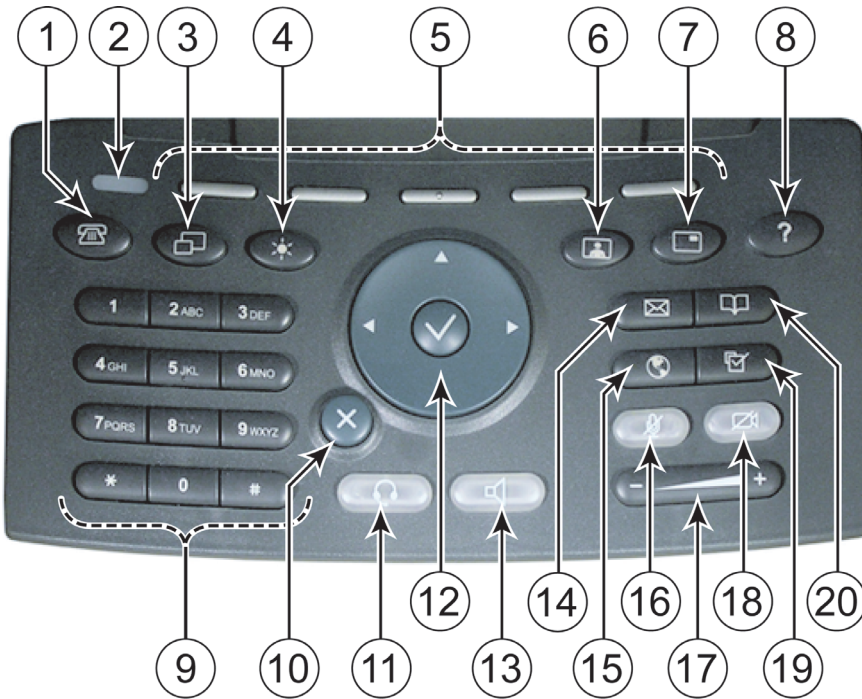







1	Camera	<p>The camera provides manual tilt and focus. Turn the lens to adjust focus. Tilt the camera by manually adjusting the tilt angle with the wheel to the right of the lens.</p> <p> Tip Press the Selfview button first to see your video picture.</p>
2	Microphone	<p>Your phone includes a microphone that is located at the top of the phone.</p>
3	LCD monitor	<p>Your phone includes an integrated 8.4 inch LCD monitor.</p>
4	Handset	<p>Your Cisco Unified IP Video Phone 7985G includes a handset that is held in place by magnets.</p>





5	Speaker	Your phone includes a speaker that is located between the keypad and the screen.
6	Camera lens cap docking	Use a camera lens cap that is located at the back side of the phone to cover the lens when the phone is not in use. The camera lens cap protects the lens and also prevents you from involuntary broadcasting your video image.
7	Keypad	The keypad contains all the keys that you need to control the system.

Cisco Unified IP Video Phone 7985G Keypad



1	Line button 	Toggles the Line menu on and off. The Line menu displays the available lines on your phone and allows you to change between lines. The Line menu also displays speed dials if you have any.
2	Notification lamp 	Flashes when you have an incoming call and when you have voice mail.
3	Display button 	Toggles the menu on and off.

4	Brightness button 	Controls monitor brightness. See the “Adjusting Monitor Brightness” section on page 39.
5	Softkeys 	Activates features presented on the corresponding softkeys on the screen.
6	Selfview button 	Switches the video image from incoming to outgoing video. See the “Displaying Your Outgoing Video Picture” section on page 23.
7	Picture in Picture 	Displays a smaller picture of the outgoing video. Press the Picture in Picture (PiP) button once and the PiP appears in the upper, right corner. Press the PiP button again to move the picture to the other three corners of the screen and, finally, hide it. See the “Displaying Your Outgoing Video Picture” section on page 23.
8	Help button 	Toggles the Help menu. See the “Getting Help on Your Phone” section on page 14.
9	Number and letter buttons	Allows you to dial phone numbers, enter letters, and choose menu items. You can also use the number keys to choose menu items.
10	Cancel button 	Allows you to go back. Use the Cancel button to delete data when you are in an input field.
11	Headset button 	Toggles the headset on or off.
12	Navigation button 	Allows you to scroll through menus and highlight items. Use this button in conjunction with softkeys to activate highlighted items. You can move the left and right arrows to navigate and edit text fields. The center button activates menu items. You also use it together with the Help button to get context sensitive help on menu items.
13	Speaker button 	Toggles the speakerphone on or off.
14	Messages button 	Toggles the message menu on and off.
15	Services button 	Toggles the Services menu on and off. The Services menu provides access to phone services, including assigned services and services to which you have subscribed.
16	Audio Mute 	Toggles the Audio Mute feature on or off. When Audio Mute is active, other callers cannot hear audio, although they can see your video image.

17	Volume button 	Controls the volume. See the “Adjusting the Volume” section on page 38.
18	Video Mute 	Toggles the Video Mute feature on or off. When Video Mute is active, other callers cannot see your video image.
19	Settings button 	Toggles the Settings menu on and off. See the “Using Phone Settings” section on page 38.
20	Directories button 	Toggles the Directories menu on and off. The Directory provides call logs (Missed, Received, and Placed) and a corporate directory. See “Using Call Logs and Directories” section on page 40.

Understanding the Screen Layout

The following example shows what your main screen might look like with an active video call. The menu appears on the screen as a semi transparent layer in front of your video image. Press  (Display button) to toggle the menu on and off.



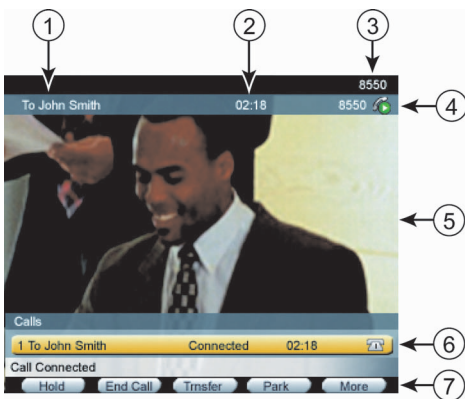

Cisco Unified IP Video Phone 7985G Screen Layout



1	ID	Displays the ID (system name) of the caller/callee.
2	Duration	Displays the duration of the call.
3	Primary line	Displays your primary number or office extension.
4	Call overview	Displays the currently active line and the configured phone number that is assigned to the line. The icon shows the state of the call. See the “Understanding Feature Buttons and Menus” section on page 14.

5	Video image	Displays the incoming video image. Press the Selfview button to display the outgoing video image.
6	Call activity	Displays your current calls per line, caller ID, call state, and call duration.
7	Softkey labels	Displays a softkey function. Press the  (Softkey button) to activate a softkey.

Understanding Feature Buttons and Menus





If you want to...	Then...
Open a feature menu	Press a feature button:  Messages  Services  Help  Directories  Settings
Scroll through a list or menu	Press the Navigation button.
Go back one level in a feature menu	Press Exit . (If you press Exit from the top level of a menu, the menu will close.)
Close a feature menu	Press the feature button (for a visible feature menu only) or press Exit one or more times until the menu closes.

Entering and Editing Text

If you want to...	Then...
Enter a letter on your screen	Press the appropriate keypad number one or more times to select a letter. When you pause, the cursor automatically advances to allow you to enter the next letter. Use the right and left navigation buttons to move through text fields.
Enter capital letters	Press the button labeled “a/A” to enter capital letters.
Delete within an entry or reposition your cursor	Press << or Delete to remove a letter or digit. Press >> to reposition the cursor to the right. You can also use the Cancel button to delete letters.

Getting Help on Your Phone

Your Cisco Unified IP Video Phone provides a comprehensive online help system. Help topics display on the screen. See the table below for details.

If you want to...	Then...
View the Main menu	Press  (Help button) on your phone and wait a few seconds for the menu to display. If you are already in Help, press Main . Choose from the following Main menu topics: <ul style="list-style-type: none"> • About Your Cisco Unified IP Phone—Descriptive information about your phone model • How do I...?—Procedures and information about commonly used phone tasks • Calling Features—Descriptions and procedures for using calling features, such as conference and transfer • Help—Tips on using and accessing Help
Learn about a button or softkey	Press  (Help button), then, quickly press a button or softkey.
Learn about a menu item	Press  (Help button), twice quickly with the menu item highlighted.
Get help using Help	Press  (Help button). After a second or two, press Main and select Help from the Main menu.

Understanding Lines Versus Calls

Be sure not to confuse *lines* and *calls* on your phone. Use these tips to avoid confusion:

Lines

Your phone can support up to a maximum of 8 lines or phone extensions, depending on how your system administrator configured your programmable buttons. To see how many lines you have, press the Line button to open the line menu. You have as many lines as you have extension numbers.







Each line can support a certain number of calls, depending on your phone's configuration. By default, each line can support a maximum of 4 calls, but your system administrator can adjust this number according to your needs. So you might find yourself handling several calls, even though you have only one line on your phone.

Calls

Each phone supports a maximum of 200 calls, but only a maximum of 100 calls per line. If you have one line, your system administrator can configure your phone to support up to 100 calls on this single line, or, if you have two lines, you might have 100 calls on each of the two lines, for a maximum of 200 calls.

Understanding Call and Line Icons

Your phone displays icons to help you determine the call and line state (on-hook, on hold, ringing, connected, and so on).

Icon	Call State	Description
	Connected call	A type of active call in which you are currently connected to the other party. Many phone features require that you have a connected call.
	Off-hook	A type of active call in which you are actively dialing a number or an outgoing call is ringing. You have not yet connected with the other party. See the “Placing a Video Call” section on page 19 for details.
	On-hook	No call activity on this line. You might be using on-hook dialing features, but the call is not in-progress until you go off-hook. See the “Placing a Video Call” section on page 19 for details.
	Ringing	A incoming call is ringing on one of your lines. See the “Placing a Video Call” section on page 19 for details.
	Call on hold	The call is on hold. See the “Using Hold and Resume” section on page 22 for details.
	Shared line	Another phone that shares the line has an active connected call. See the “Using a Shared Line” section on page 31 for details.



Going On-Hook and Off-Hook

Some phone tasks and instructions differ depending on whether the phone is *on-hook* or *off-hook*.

- On-Hook—The phone handset rests in the cradle, no calls are active, and you do not have an active dial tone. Your phone provides *on-hook dialing*, which enables you to enter or choose phone numbers before activating the call.
- Off-Hook—The phone handset is lifted from the cradle, the speakerphone is active, or any of several other methods are used to get a dial tone (to make a call) or to answer an incoming call.



Selecting Calls

Many phone features require that you select the calls you want to use with a particular feature. For example, you might have 15 held calls, but you only want to join 4 of them to a conference call. (The default maximum number of participants is 4). You can select just the calls you want to add to the conference call before activating the feature.

If you want to...	Then...
Highlight a call	Use the Navigation button to scroll through the call list.
Select a call	Highlight a connected or held call and press Select . Selected calls are indicated with a  (Check mark) next to them.
Verify selected calls	Use the Navigation button to scroll through the list of calls. Selected calls are indicated with a  (Check mark) and are grouped together in the call list.

Switching Among Calls

Your phone can support multiple calls on each line, depending on how your system administrator configured your phone. These tips can help you switch among calls on one or more lines.

If you want to...	Then...
Switch between calls on one line	Highlight the call to which you are switching and press Resume . The other call is placed on hold automatically.
Switch from a connected call to answer a ringing call	Press Answer to answer the new call and place the first call on hold automatically.
Switch between calls on different lines	Press  (Line button) and select a line. Select a call and press Resume .
Show current calls on a specific line	Press  (Line button) and select a line. The call activity area displays current call information for that line. When you switch from one line to another, any connected calls on the first line automatically get placed on hold.
Display an overview of calls	Press  (Line button) to get an overview of the first call on each of your lines.

Tips

- You can have only one call be active at any given time; other calls will get placed on hold automatically.
- When you have multiple calls on one line, calls with the highest precedence and longest duration display at the top of the call list.
- The call list shows calls of a similar type grouped together. For example, any calls with which you have interacted get grouped together near the top. Next the list shows all selected calls grouped together. Finally, the list shows any calls that you have not yet answered or with which you have otherwise interacted grouped near the bottom of the list.

Understanding Feature Functionality and Availability



The operation of your Cisco Unified IP Video Phone and the features available to you may vary, depending on the call processing agent used by your company and also on how your company's phone support team has configured your phone system. Therefore, some of the features this Video Phone Guide includes might not be available to you or might work differently on your phone system. Contact your support desk or system administrator if you have questions about feature availability.

Basic Call Handling

This section covers basic call-handling tasks such as placing, answering, transferring, and conferencing calls. You can find the standard features that you use to perform these tasks on most phone systems.



Before You Make a Video Call









Before making a video call, make sure that you are positioned within the reach of the camera and that the lighting conditions are good.

If you want to...	Then...
See your video picture	Remove the camera lens cap from the camera. Press  (Selfview button) to see your video picture if not already displayed.
Adjust the camera	The camera has manual tilt and focus. Turn the camera up and down to adjust tilt. Rotate the camera lens to adjust focus.
Adjust monitor brightness	Press  (Brightness button) to adjust brightness.

Placing a Video Call

When you call to another video phone, the call will automatically be set up as a video call and you will see the callee's video picture on the screen as soon as the call is connected. To place a video call, use one of several options to go off-hook before or after dialing a number.

If you want to...	Then...
Dial off-hook	The call menu displays when the handset is lifted from its cradle. Dial a video or phone number and wait for the call to connect.
Dial on-hook (no dial tone)	Enter a video or phone number with the number keys. Then, to place the call, do one of these things to go off-hook: <ul style="list-style-type: none"> • Lift the handset. • Press  (Speaker button) or  (Headset button). • Press Dial.



If you want to...	Then...
Dial by using the speakerphone	<p>Press New Call and enter a video or phone number, or you can press  (Speaker button) before or after dialing, redialing, or speed dialing a number.</p> <p>Many of the actions that you can take to dial a number automatically trigger speakerphone mode, assuming that the handset is in its cradle and the  (Headset button) is not lit. These actions include pressing Redial and using speed dials.</p>
Redial the most recently dialed number	Press Redial . To use another line, press  (Line button), choose a line, and press redial.
Dial from a call log	<p>Choose  (Directories button) > Missed Calls, Received Calls, or Placed Calls. To dial from a listing, press the number or scroll to it and go off-hook.</p> <p>To add a prefix or other digits to the number before dialing, press EditDial.</p>
Dial from a corporate directory on the phone	Choose  (Directories button) > Corporate Directory (exact name can vary). Search for a listing by using your keypad to enter letters. (You can search by using a partial name.) To dial from a listing, press it or scroll to it and go off-hook.
Place a call when another call is active	Press Hold ; next, press New Call ; then, dial, redial, or speed dial a number.
Dial by using a headset	<p>Do one of the following actions:</p> <ul style="list-style-type: none"> • If  (Headset button) is unlit, press it before or after dialing, redialing, or speed-dialing a number. • If  (Headset button) is lit, press New Call, Redial. If necessary, enter a phone number.
Receive notification when a busy or ringing extension becomes available	Call the number and press CallBack while listening to the busy tone or ring sound. Hang up. When the extension becomes available, your phone will provide you with a visual alert. (Because the callback to this number is not automatic you must place the call.) CallBack represents a special feature that your system administrator can configure for your phone.
Dial on a secondary line	The active line is noted at the top of the video screen. Before dialing the number, press  (Line button) and select the line that you want to use.
Dial by using speed dials	Press  (Line button) and select a speed dial. The phone will make a call to the selected speed dial. For details, see the “Speed dialing” section on page 29.
Make a priority (precedence) call	Enter the MLPP access number (which your system administrator provides) followed by the phone number. For more details, see the “Prioritizing Critical Calls” section on page 34.

Tips

If you make a mistake while entering a phone number, press << or the Cancel button to erase one or more digits. Use the right and left navigation buttons to move through the number. Press **Cancel** to exit the dialing attempt.



Answering a Video Call

Answer a video call the same way as you answer a telephone call, go off-hook. See the table below for details.

If you want to...	Then...
Answer while you are using the handset	Pick up the handset from its cradle to answer an incoming call.
Answer while you are using the headset	Press  (Headset button), if it is unlit. Or, if  (Headset button) is already lit, press Answer .
Answer with the speakerphone	Press  (Speaker button), Answer .
Switch from a connected call to answer a ringing call	Press Answer . Doing so answers the new call and automatically places the first call on hold. See the “Using Hold and Resume” section on page 22 for more information.
Set up your phone to automatically connect an incoming call after a ring or two	Ask your system administrator to set up the AutoAnswer feature. For more information, see the “Using AutoAnswer with a Headset or the Speakerphone” section on page 37.
Retrieve, or allow someone else to retrieve, a held call on another phone (such as a phone in a conference room)	Use Call Park. See the “Picking Up a Ringing Call to Your Phone” section on page 30.
Use your phone to answer a call that is ringing on another phone	Use Call Pickup. See the “Picking Up a Ringing Call to Your Phone” section on page 30.
Answer a priority call	Hang up the current call and press Answer . See the “Prioritizing Critical Calls” section on page 34.
Send an incoming call directly to the voice-messaging system	Press iDivert . The incoming call automatically transfers to your voice-message greeting.

Ending a Video Call

End a video call the same way as you end a telephone call, hang up. See the table below for details.

If you want to...	Then...
Hang up while you are using the handset	Return the handset to its cradle or press EndCall .
Hang up while you are using the headset	Press  (Headset button), if it is lit. Or, if you want to keep headset mode activated (keep the button lit after hanging up), press EndCall .
Hang up while you are using the speakerphone	Press  (Headset button) or EndCall .
Hang up one call but preserve another call on the same line	Press EndCall . If necessary, remove the call from hold first.

Placing a Telephone Call

When you dial a telephone number, the call will automatically be set up as a telephone call. To place a telephone call, use one of the same options to go off-hook before or after dialing a number as described for video calls, see the “Placing a Video Call” section on page 19.

Using Hold and Resume

You can have only one active call at any given time; all other calls must be placed on hold.





If you...	Then...
Want to put a call on hold	Make sure that the call that you want to put on hold is highlighted and press Hold .
Want to remove a call from hold	Make sure that the call that you want to remove from hold is highlighted and press Resume .
Have multiple calls on multiple lines on hold	Press  (Line button) and choose the line on which the call that you want to resume is. If necessary, make sure that the call that you want to remove from hold is highlighted and press Resume .

Tips

Engaging the Hold feature typically generates music or a beeping tone. For this reason, avoid putting a conference call on hold.



Displaying Your Outgoing Video Picture

To see your outgoing video picture (the picture of yourself), use Selfview or PiP (Picture in Picture). Selfview displays your outgoing picture in full screen. PiP shows your outgoing picture in a smaller window. The PiP displays on top of the bigger, incoming picture when you are in a call, which allows you to see both pictures at the same time. You can use Selfview and PiP both when you are outside a call and when you are in a video call.

If you want to...	Then...
See outgoing picture in full screen	Press  (Selfview button). Press  (Selfview button) again to switch back.
See outgoing picture as a smaller picture	Press  (PiP button).
Move the PiP to another corner of the screen.	Press  (PiP button) repeatedly to move the PiP to the other three corners of the screen.
Hide the PiP.	The fourth time that you press  (PiP button), the PiP disappears.

Muting Video or Audio

Mute disables the video or audio input for your handset, headset, speakerphone, and external microphone. With Video Mute enabled, you can see other parties on a call, but they cannot see you. With Audio Mute enabled, you can hear other parties on a call, but they cannot hear you. The video and audio mute buttons remains until you turn it off.

If you want to...	Then...
Toggle Video Mute on	Press  (Video Mute button).
Toggle Video Mute off	Press  (Video Mute button).
Toggle Audio Mute on	Press  (Audio Mute button).
Toggle Audio Mute off	Press  (Audio Mute button).

Transferring Calls

Transfer redirects a connected call. The *target* specifies the number to which you want to transfer the call.

If you want to...	Then...
Transfer a call without talking to the transfer recipient	During a connected call, press Transfer and enter the target number. When you receive the call ringing sound, press Transfer again.
Talk to the transfer recipient before transferring a call (“consult transfer”)	During a connected call, press Transfer and enter the target number. Wait for the transfer recipient to answer. If the recipient accepts the transferred call, press Transfer again. If the recipient refuses the call, press Resume to return to the original call.
Transfer two current calls to each other (“direct transfer”)	Scroll to highlight any call on the line and press Select . Repeat this process for the second call. With one of the selected calls highlighted, press DirTrfr . (You may need to press the more softkey first.) The two calls connect to each other and drop you from the call. If you want to stay on the line with the callers, use Join to create a conference instead. For details, see the “Making Conference Calls” section on page 26.

Tips

- You can only transfer a call on hold if you are using Direct Transfer, otherwise, press **Resume** to take a selected call off hold; then, transfer it.
- When you transfer calls, ensure all calls are on the same line.

Forwarding Your Calls to Another Number

You can use Call Forward All to redirect your incoming calls from your Cisco Unified IP Video Phone to another number. Call Forward All can only be used on your primary line.



Note Enter the Call Forward All target number exactly as you would dial it from your desk phone. For example, enter an access code such as 9 or the area code, if necessary.

If you want to...	Then...
Set up call forwarding on your primary line	Press CFwdALL and enter a target phone number.
Cancel call forwarding on your primary line	Press CFwdALL .
Verify that call forwarding is enabled on your primary line	Look at the status line and call state icon for the line. When call forwarding is enabled, a message appears in the status line to indicate the number to which calls are being forwarded, and this icon appears above the primary line:  (Call forward icon).

Tips

- You can forward your calls to a traditional analog phone or to another Cisco Unified IP Video Phone, although your system administrator may restrict the call forwarding feature to numbers within your company.

You must configure this feature per line; if a call reaches you on a line where call forwarding is not enabled, the call will ring as usual.

Making Conference Calls

Conference calling allows three or more parties to participate in a call simultaneously. Your Cisco Unified IP Video Phone can support several types of conference calls depending on your needs and your phone configuration. The softkeys identify which methods are available on your phone:

- **Confrrn**—Use this softkey to establish standard conferences by calling each participant individually. Standard conference calling represents a default feature that is available on most phones.
- **Join**—Use this softkey to establish a standard conference among several calls who are already on the line.
- **cBarge**—Use this softkey to establish a standard conference call on a shared line. Your system administrator must configure this optional feature that is available only for shared lines.
- **Meet-Me**—Use this softkey to host a conference (up to 100 participants, depending on configuration) that requires participants to call an established number at a specific time. Your system administrator must configure this optional feature for you.

Starting and Joining a Standard Conference

A standard conference allows at least three people to participate in a single call. The conference gets set up as an audio conference or a video conference depending on how your system administrator configured your phone. The system administrator also configures what kind of view that is displayed. The **VidMode** softkey allows the user to switch between Voice Activated and Continuous view of the conference. Voice Activated view displays the speaking part in full screen. Continuous view displays all participants on the screen simultaneously.

If you want to...	Then...
Invite current callers to join a standard conference	With two or more calls on a single line, scroll to highlight any call on the line and press Select . Repeat this process for each call that you want to add to the conference. From one of the selected calls, press Join . (You may need to press the more softkey first.) The selected calls automatically gets added to the conference. All selected calls must be on the same line.
Establish a standard conference call by calling participants	During a connected call, press Confrrn to add another party to the call. (You may need to press the more softkey first.) Enter the conference participant phone number. After the call connects and you have spoken to the conference participant, press Confrrn again to add this party to your call. Follow this procedure to add each participant.
Join a standard conference	Answer the phone when it rings. You do not need to do anything special to join a standard conference call.

If you want to...	Then...
Establish a standard conference call by using a shared line	Highlight a remote-in-use call on a shared line and press cBarge . (You may need to press the more softkey first.) See the “Using a Shared Line” section on page 31 for details.
View a list of conference participants	Highlight an active conference and press ConfList . The participants list shows the order in which participants join the conference with the most recent additions at the top.
Get an updated list of conference participants	While viewing the conference list, press Update .
See who started the conference	While viewing the conference list, locate the person who is listed at the bottom of the list with an asterisk (*) next to the name.
Remove any conference participant	Highlight the participant name and press Remove . You can only remove a participant if you initiated the conference call.
Drop the last party who was added to the conference	Highlight the participant name at the top of the conference list and press Remove . The last participant to the conference always appears at the top of the list, or when not viewing the conference list, simply press RmLstC . You can only remove a participant if you initiated the conference call.
End a standard conference	Hang up or press EndCall . Note that hanging up will not necessarily mean that the conference will terminate. CallManager dictates this by the Drop Ad Hoc Conference service parameter, which defaults to Never, but can be set by the admin to "When Conference Creator Drops Out" or "When No OnNet Parties Remain In The Conference".

Tips

- For participation in a standard conference, ensure all calls are placed on the same line. If this is not the case, you can transfer the calls to the same line before adding them to the conference.
- If you receive an error message stating, “No Participant Info” when you attempt to use **Join**, be sure that you selected at least one call in addition to the active call, which is selected automatically.

Starting or Joining a Meet-Me Conference Call

Unlike a standard conference, where the conference organizer must call participants, a Meet-Me conference call allows participants to dial a Meet-Me conference number at a predetermined time to join the conference call. Your system administrator may configure the Meet-Me conference calling option, which is a special feature for you.

If you want to...	Then...
Establish a Meet-Me conference	Press Meet-Me , if available. (You may need to press the more softkey first.) Dial the Meet-Me conference number that your system administrator provided or phone help desk.
Join a Meet-Me conference	Dial the Meet-Me conference number that the conference initiator provided. You can join after the initiator has established the conference. Do not use the Meet-Me softkey to join the established conference.
End a Meet-Me conference	Hang up or press EndCall .

Advanced Call Handling

Advanced call-handling tasks involve special features that your system administrator might configure for your video phone depending on your call-handling needs and work environment.

Speed dialing

Speed dial numbers allow you to quickly dial phone numbers without having to enter the phone number each time. For example, you can assign phone numbers you call frequently as speed dial numbers. The Lines menu lists speed dials.

To use speed dials, follow these steps:

Step 1 Press  (Line button).

Step 2 Select a speed dial from the Lines menu, and the phone will make a call to the selected speed dial.

Set up speed dials from your User Options web pages, as described in the table below.

If you want to...	Then...
Add speed dial numbers to the phone	<p>Log in to your User Options web pages, select your device, and then choose Add/Update Speed Dials from the main menu.</p> <p>In the Speed Dial Settings on Phone section, enter a phone number and label for each available speed dial line. Enter the number exactly as you would need to dial it from your desk phone. For example, enter an access code such as 9 or the area code, if necessary.</p> <p>The label that you enter displays as a speed dial in the lines menu on your screen.</p>
Add speed dial numbers to use with Abbreviated Dialing	<p>Log in to your User Options web pages, select your device, and then choose Add/Update Speed Dials from the main menu.</p> <p>In the Speed Dial Settings, enter a phone number and label for each available speed dial. Enter the number exactly as you would need to dial it from your desk phone. For example, enter an access code such as 9 or the area code, if necessary.</p>



Note Your system administrator can assign speed dials to your phone; he or she can also restrict the number of speed dials that you can configure

Tips

For details on making calls by using either speed dial method, see the “Placing a Video Call” section on page 19.

Picking Up a Ringing Call to Your Phone

Your system administrator might enable Call PickUp for your phone if you share call-handling responsibilities with co-workers. Call PickUp allows you to answer a call that is ringing on a coworker’s phone by redirecting the call to your own phone. You can use Call PickUp features to handle calls for co-workers who are in your call pickup group (**PickUp**), who are in another pickup group (**GPickUp**), or who are in a group associated with your group (**OPickUp**).

If you want to...	Then...
Answer a call that is ringing on another extension within your group	Press PickUp to connect the call. (You might have to go off-hook to press PickUp). If your system administrator did not enable auto-pickup, the call will ring on your phone when you press PickUp . In this case, press Answer to connect the call.
Answer a call that is ringing on another extension outside of your group	Press GPickUp to connect the call. (You might have to go off-hook to press GPickUp .) Enter the group pickup code provided by your system administrator to connect to the call. If your system administrator did not enable auto-pickup, the call will ring on your phone when you press GPickUp and enter the group pickup code. In this case, press Answer to connect the call.
Answer a call that is ringing on another extension in your group or in associated group	Press OPickUp to connect the call. (You might have to go off-hook to press OPickUp .) If your system administrator did not enable auto-pickup, the call will ring on your phone when you press OPickUp . In this case, press Answer to connect the call.

Tips

- When you press **PickUp** and **GPickUp**, you connect to the call that has been ringing for the longest time.

- With **OPickUp**, your system administrator can associate multiple call pickup groups with your group and assign a priority to the groups. When you press **OPickUp**, you connect the ringing call in the pickup group with the highest priority.
- If you want to pick up the call on an extension other than your primary line, first press an available line button and then press a Call PickUp softkey.

Using a Shared Line

Your system administrator might assign a “shared” phone line to you. Typically, a shared line has two main uses:

- One person uses multiple phones—For example, your shared line is assigned to both your desk phone and a lab phone. An incoming call to the shared line rings on both phones and you can use either phone to answer the call.
- Multiple people share a line—For example, you are one of many people who can handle incoming calls on the shared line, or you are a manager who shares an extension number with your assistant.

Understanding Shared Lines

Remote-in-Use

If you have a shared line, you might see the remote-in-use icon on your phone screen:  (Shared line icon. This icon indicates that a co-worker is currently using the shared line. You can place and receive calls as usual on a shared line, even when the remote-in-use icon appears.

Sharing Call Information and Barging

Unless a co-worker who shares your line has the Privacy feature enabled, you can see information on your phone screen about calls that your co-worker places and receives on the shared line. This information might include caller ID and call duration. Conversely, when you are using a shared line, information about your call is displayed on the co-worker’s phone screen.

When call information is visible in this way, you and co-workers can add yourselves to calls on the shared line using either the Barge or cBarge feature. Adding yourself to a call on a shared line is called *barging*. For more information about barging, see the “Adding Yourself to a Shared-Line Call” section on page 32.

Privacy



If you do not want co-workers who share your line to see information about your calls, enable the Privacy feature. Doing so also prevents co-workers from barging your calls. See the “Preventing Others from Viewing or Barging a Shared-Line Call” section on page 33.

Maximum Supported Calls on a Shared Line

The maximum number of calls that a shared line supports can vary by phone. Thus, at times you might not be able to make a new call on the shared line even if your co-worker can. For example, your phone supports a maximum of four calls on a shared line and your co-worker's phone supports five calls on the same line. If there are four calls on the line, the **NewCall** softkey is unavailable to you but available to your co-worker.

Adding Yourself to a Shared-Line Call

Depending on how your phone is configured, you can add yourself to an established call on a shared line using **Barge** or **cBarge**. Typically, only *one* of these features will be available to you.

If you want to...	Then...
See if a co-worker has an active call on the shared line	<p>Look at shared line number. When the line is in use from another phone, the remote-in-use icon:  (Shared line icon) is displayed.</p> <p>If your co-worker has Privacy enabled, the Barge and cBarge softkeys are not available and you cannot barge the call. In this case, you cannot view information for the private call on your touchscreen, but you can still use the shared line to place and receive new calls.</p>
View current calls on the shared line	Press  (Line button) and select a line. All non-private calls display on the call activity area.
Add yourself to call on a shared line using the Barge softkey	<p>Highlight a remote-in-use call on your screen and press Barge. (You may need to press the more softkey to display Barge.) Other parties hear a beep tone announcing your presence.</p> <p>When you hang up, the remaining parties hear a disconnect tone and the original call continues.</p>
Add yourself to call on a shared line using the cBarge softkey	<p>Highlight a remote-in-use call on your touchscreen and press cBarge. (You may need to press the more softkey to display cBarge.) Other parties hear a tone and brief audio interruption, and call information changes on the phone screen.</p> <p>Note that, unlike Barge, cBarge converts the call into a standard conference call, allowing you to add new conference participants to the call. (To learn more about conference features that you can use with cBarge, see the “Making Conference Calls” section on page 26.)</p> <p>When you hang up, the call remains a conference call (provided at least three participants remain on the line).</p>

Tips

- **Barge** and **cBarge** softkeys are not available for private calls.
- You cannot barge an encrypted call if the phone you are using is not configured for encryption. When your barge attempt fails for this reason, your phone plays a fast busy tone.
- You will be disconnected from a call that you have joined using Barge if the call is put on hold, transferred, or turned into a conference call.

Preventing Others from Viewing or Barging a Shared-Line Call

If you use a shared line, you can use the Privacy feature to prevent others who share this line from viewing or barging your calls (adding themselves to calls on the shared lines using the Barge or cBarge feature.)

If you want to...	Then...
Prevent others from viewing or joining any calls on a shared line.	Press Private .
Allow others to view or join any calls on a shared line.	Press Private .

Tips

- If the phone that shares your line has Privacy enabled, you can make and receive calls using the shared line as usual. However, you cannot add yourself to existing calls on the shared line, and the barge softkeys will not be available to you.
- The privacy feature applies to all shared lines on the phone. Consequently, if you have multiple shared lines on your phone and Privacy is enabled, coworkers will not be able to view or barge calls on any of your shared lines.

Storing and Retrieving Parked Calls

You can “park” a call when you want to store the call, so you or someone else can retrieve it from another phone in the Cisco Unified CallManager system (for example, at a coworker’s desk or in a conference room). Call Park designates a special feature that your system administrator may configure for you.

If you want to...	Then...
Store an active call by using Call Park	During a call, press Park (you may need to press the more softkey first). This prompts your phone to store the call. Make a note of the call park number that displays on your screen and hang up.
Retrieve a parked call	From any Cisco Unified IP Video Phone in your network, enter the call park number to connect to the call.



Note

You have limited time to retrieve the parked call before it reverts to ringing at its original destination. Your system administrator can explain this time limit.

Tracing Suspicious Calls

If you are receiving suspicious or malicious calls, your system administrator can add the Malicious Call Identification (MCID) feature to your phone. This feature enables you to identify an active call as suspicious, which initiates a series of automated tracking and notification messages.

If you want to...	Then...
Identify a suspicious call	Press MCID . You will receive a special tone and see the message, “MCID successful” on your phone. The call remains active until you end the call.





Prioritizing Critical Calls

In some specialized environments, such as military or government offices, you might need to make and receive urgent or critical calls. These critical calls might require higher priority handling, such as being able to preempt other calls. If you have the need for this specialized call handling, your system administrator can add Multilevel Precedence and Preemption (MLPP) to your phone.

Keep these terms in mind:

- *Precedence* indicates the priority associated with a call.

- *Preemption* is the process of ending an existing, lower priority call while accepting a higher priority call that is sent to your phone.







If you want to...	Then...
Choose a priority (precedence) level for an outgoing call	Contact your system administrator for a list of corresponding precedence numbers for calls (ranging from low to highest).
Make a priority (precedence) call	Enter the MLPP access number (which is provided by your system administrator) followed by the phone number.
Receive a priority (precedence) call	Hear the special call waiting tone and note the special icon displayed in the call activity area for the incoming call.
View priority level of a call	<p>Higher priority calls display at the top of your call list, and these icons indicate the assigned priority as follows:</p> <ul style="list-style-type: none"> No icon—Normal (routine) call  Green—Low priority (priority) call  Yellow—Medium priority (immediate) call  Orange—High priority (flash) call  Red—Highest priority (flash override) call
Accept an higher-priority call	End an active call and answer the higher-priority call.

Tips

- When you make or receive an MLPP-enabled call, you will hear special ring tones and call waiting tones that differ from the standard tones.

Using a Headset, and Speakerphone

The table below describes how to use these devices.

If you want to...	Then...
Use a headset	<p>Press  (Headset button) to toggle headset mode on and off. (AutoAnswer users should see the “Using AutoAnswer with a Headset or the Speakerphone” section on page 37 for exceptions.)</p> <p>You can use the headset in conjunction with all of the controls on your phone, including  (Volume button) and  (Audio mute button).</p> <p>See the “Obtaining a Headset” section on page 36 for headset purchasing information.</p>
Use the speakerphone	<p>Press  (Speaker button) to toggle speakerphone mode on or off.</p> <p>Many of the actions that you can take to dial a number or answer a call automatically trigger speakerphone mode, assuming that the handset is in its cradle and the  (Headset button) is not lit.</p>
Switch to the headset or speakerphone (from the handset) during a call	<p>Press  (Speaker button) or  (Headset button); then, hang up the handset.</p>
Switch to the handset (from the speakerphone or headset) during a call	<p>Lift the handset (without pushing any buttons).</p>

Tips





- See the “Connecting Your Video Phone” section on page 6 to locate the headset port.
- See the “Basic Call Handling” section on page 19 for detailed instructions about how to use the headset and speaker to place, answer, end, and otherwise handle calls.

Obtaining a Headset

Your phone supports 2.5mm 3-pole headset jacks. For information about purchasing headsets, see the following URL: <http://www.plantronics.com, products, mobile>.

Using AutoAnswer with a Headset or the Speakerphone

You might use AutoAnswer if you receive a high volume of incoming calls or handle calls on behalf of others. AutoAnswer is configured on the CallManager. Your system administrator configures AutoAnswer to work with either your speakerphone or headset. See the table below for details.

If you...	Then...
Use AutoAnswer with a headset	Keep  (Headset button) activated (lit) by pressing EndCall or a line button to hang up. Keeping  (Headset button) activated ensures that audio input/output will be directed through the headset instead of the speakerphone and that AutoAnswer will function with your headset.
Use AutoAnswer with the speakerphone	Press  (Speaker button) or  (Speaker button) as you normally would to place, answer, and end calls, open and close lines, and switch from another audio device to speakerphone mode.



Using Phone Settings

You can personalize your Cisco Unified IP Video Phone by adjusting settings, as described in the tables below. Keep in mind a few tips when you review this information:

- Most settings are accessible on your phone, but a few are accessed online from your User Options web pages. See the “Logging In to the User Options Web Pages” section on page 44 for more information.
- If  (Settings button) is not responsive, your system administrator may have disabled this button on your phone. Ask your system administrator for more information.

Adjusting the Volume

The table below describes how to adjust and save volume levels on your phone.

If you want to...	Then...
Adjust the volume level for a call	Press  (Volume button) during a call or after invoking a dial tone. Doing so adjusts the volume level for the currently active audio mode. For example, if you increase the volume while you are using the handset, you do not affect the speakerphone volume. Press Save to preserve the new volume as the default level for this audio mode. If you adjust the handset, headset, or speakerphone volume without saving the change, the volume will revert to the previously saved level the next time that you use that audio mode.
Adjust the volume level for the ringer	Press  (Volume button) while the handset is in the cradle and the headset and speakerphone buttons are off. The new ringer volume gets saved automatically.

Customizing Alert Tone

You can customize the way that your phone indicates the presence of an incoming call.

If you want to...	Then...
Change the Alert Tone	Choose Settings > User Preferences > Alert Tone and select a phone line or the default ring setting. Choose a ring type to play a sample of it. When you have selected the ring that you want, press Select and Save . Press Cancel to revert to the previously saved setting.
Download Alert Tones	You can download more Alert Tones to your Video Phone from the Cisco Unified CallManager.

Adjusting Monitor Brightness

You can adjust the monitor brightness on your screen.

If you want to...	Then...
Change the monitor brightness	Press  (Brightness button) and adjust brightness with Up , Down . You can also choose Settings > User Preferences > Monitor Brightness . To make adjustments, press Up , Down ; then, press Save . Press Cancel to revert to the previously saved setting.

Adjusting Camera Brightness, Hue and Saturation

You can adjust the camera brightness, hue and saturation.



If you want to...	Then...
Change camera brightness	Choose Settings > User Preferences > Camera Settings and select Brightness . To make adjustments, press Up , Down ; then, press Save . Press Cancel to revert to the previously saved setting.
Change camera hue	Choose Settings > User Preferences > Camera Settings and select Hue . To make adjustments, press Up , Down ; then, press Save . Press Cancel to revert to the previously saved setting.
Change camera saturation	Choose Settings > User Preferences > Camera Settings and select Saturation . To make adjustments, press Up , Down ; then, press Save . Press Cancel to revert to the previously saved setting.

Using Call Logs and Directories

This section describes how you can use feature buttons to access call logs and directories. To access both features, use the  (Directories button).

Using Call Logs



Your phone maintains records of your missed, placed, and received calls.

If you want to...	Then...
View your call logs	Choose  (Directories button) > Missed Calls , Placed Calls , or Received Calls . Each stores up to 100 records. To view a truncated listing, highlight it and press EditDial .
Erase your call logs	Press  (Directories button), then press Clear . Doing so erases all records in all logs.
Dial from a call log (while not on another call)	<ol style="list-style-type: none">1. Choose  (Directories button) > Missed Calls, Placed Calls, or Received Calls.2. Highlight a call record from the log.3. If you need to edit the displayed number, press EditDial followed by << or >>. To delete the number, press EditDial followed by Delete. (You may need to press the more softkey to display Delete.)4. Go off-hook to place the call.

If you want to...	Then...
Dial from a call log (while connected to another call)	<ol style="list-style-type: none"> <li data-bbox="364 188 1268 256">1. Choose  (Directories button) > Missed Calls, Placed Calls, or Received Calls. <li data-bbox="364 261 1268 293">2. Highlight a call record from the log. <li data-bbox="364 298 1268 396">3. If you need to edit the displayed number, press EditDial followed by << or >>. To delete the number, press EditDial followed by Delete. (You may need to press the more softkey to display Delete.) <li data-bbox="364 401 1268 433">4. Press Dial. <li data-bbox="364 438 1268 708">5. Choose a menu item to handle the original call: <ul style="list-style-type: none"> <li data-bbox="364 483 1268 516">• Hold—Puts the first call on hold and dials the second. <li data-bbox="364 521 1268 586">• Transfer—Transfers the first party to the second and drops you from the call. (Press Transfer again after dialing to complete the action.) <li data-bbox="364 591 1268 656">• Conference—Creates a conference call with all parties, including you. (Press Confrn again after dialing to complete the action.) <li data-bbox="364 660 1268 708">• EndCall—Disconnects the first call and dials the second.

Using Corporate Directory on Your Phone

Depending on configuration, your phone can provide access to a corporate directory which you can use to place calls to coworkers. Corporate Directory is set up and maintained by your system administrator.

If you want to...	Then...
Dial from a corporate directory (while not on another call)	<ol style="list-style-type: none">1. Choose  (Directories button) > Corporate Directory (exact name can vary).2. Use your keypad to enter a full or partial name and press Search.3. To dial, select the listing that you want to dial, or scroll to the listing and go off-hook.
Dial from a corporate directory (while connected to another call)	<ol style="list-style-type: none">1. Choose  (Directories button) > Corporate Directory (exact name can vary).2. Use your keypad to enter a full or partial name and press Search.3. Scroll to a listing and press Dial.4. Choose a menu item to handle the original call:<ul style="list-style-type: none">• Hold—Puts the first call on hold and dials the second.• Transfer—Transfers the first party to the second and drops you from the call. (Press Transfer again after dialing to complete the action.)• Conference—Creates a conference call with all parties, including you. (Press Confrn again after dialing to complete the action.)• EndCall—Disconnects the first call and dials the second.

Tip





Use the numbers on your keypad to enter characters on your phone screen. Use the Navigation button on your phone to move between input fields.

Accessing Voice Messages

To access voice messages, use the  (Messages button).



Note Your company determines the voice-messaging service that your phone system uses. For the most accurate and detailed information about this service, refer to the documentation that came with your voice message service..

If you want to...	Then...
Set up and personalize your voice-messaging service	Press  (Messages button) and follow the voice instructions. If a pop-up messages menu displays on your screen, choose an appropriate menu item.
See whether you have a new voice message	Look at your phone for the following indicators: <ul style="list-style-type: none">• The red notification lamp is lit.• An envelope icon  (Voice message icon) displays on your screen.
Listen to your voice messages or access the voice messages menu	Press  (Messages button). Depending on your voice-messaging service, pressing  (Messages button) either auto-dials the message service or provides a pop-up menu on your screen. If you see the pop-up menu, choose Voice Mail or Voice Messages to auto-dial your voice-messaging system.
Send a call to your voice message system	Press iDivert . The iDivert feature automatically transfers a call (including a ringing or held call) to your voice-messaging system. Callers will hear your voice message greeting and can leave you a message.

Accessing Your User Options Web Pages

Because your Cisco Unified IP Video Phone is a network device, it can share information with other network devices in your company, including your computer and web-based services accessible using a web browser on your computer.

You can establish phone services, and control settings and features from your computer using the Cisco Unified CallManager User Options web pages. Once you configure these services, you can access them from your phone.

This section describes how to access your User Options web pages and how to subscribe to phone services. For more details about the features you can configure and the phone services to which you can subscribe, refer to *Customizing Your Cisco Unified IP Phone on the Web* at the following URL:

http://www.cisco.com/univercd/cc/td/doc/product/voice/c_ipphon/index.htm

Logging In to the User Options Web Pages

Procedure

Step 1 Obtain a User Options URL, user ID, and default password from your system administrator.

Step 2 Open a web browser on your computer and enter the URL (provided by your system administrator) and log on.

Step 3 From the general menu, select your device type (phone model) in the “Select a device” drop-down list.

After you make your selection, a context-sensitive menu appears with options appropriate for your device type.

Tips for Navigating the User Options Pages

- Select your device from the menu page to see all of your options.
- Click **Update** to apply and save your changes.
- Click **Return to the Menu** to get back to the context-sensitive menu.
- Click **Log Off** to exit the User pages.



Subscribing to Phone Services

Before you can access subscription phone services on your phone, you need to subscribe to them by using your computer to access the User Options web pages. See the “Logging In to the User Options Web Pages” section on page 44 for help logging in.)

Services can include:

- Web-based information, such as stock quotes, movie listings, and weather reports
- Network data, such as corporate calendars and searchable directories
- Phone features, such as My Fast Dials and a Personal Address Book

Refer to the table below for more information.

If you want to...	Then do this after you log in and select your device type...
Subscribe to a service	From the main menu, choose Configure your Cisco IP Phone Services . Select a service from the “Available Services” drop-down list and click Continue . Enter more information upon request (such as a zip code or PIN), then click Subscribe .
Change or end subscriptions	From the main menu, choose Configure your Cisco IP Phone Services . Click a service in the “Your Subscribed Services” panel. Click Update after making changes, or click Unsubscribe .
Add a service to the lines menu	After subscribing to a service, choose Add/Update your Service URL Buttons from the main menu. For each available line, select a service from the drop-down list and enter a text description. Click Update after making changes. Your system administrator determines how many lines are available for services.
Access a service on your phone	Press  (Services button) on your phone. Or, if you have added a service to a the lines menu, press  (Line button) and press the corresponding number to select the service.
Learn how to use phone services	See <i>Customizing Your Cisco Unified IP Phone on the Web</i> : http://www.cisco.com/univercd/cc/td/doc/product/voice/c_ipphon/index.htm

Understanding Additional Configuration Options

Your system administrator can configure your phone to use specific button and softkey templates along with special services and features, if appropriate. The table below provides an overview of some configuration options that you may want to discuss with your phone system administrator based on your calling needs or work environment.



Note You can locate Phone Guides and other documents listed in this chapter from the following URL: http://www.cisco.com/univercd/cc/td/doc/product/voice/c_ipphon/index.htm.

If you...	Then...	For more information...
Need to handle more calls on your phone line	Ask your system administrator to configure your line to support more calls.	Talk to your system administrator or phone support team.
Need more than one phone line	Ask your system administrator to configure one more directory number for you.	Talk to your system administrator or phone support team.
Work with (or work as) an administrative assistant	Consider using: <ul style="list-style-type: none">• The Cisco Unified IP Manager Assistant service• A shared line	See the <ul style="list-style-type: none">• “Using a Shared Line” section on page 31• <i>Cisco Unified IP Manager Assistant User Guide</i>
Want to use one extension for several phones	Request a shared line. This allows you for example to use one extension number for your desk phone and mobile phone.	See the “Using a Shared Line” section on page 31.



If you...	Then...	For more information...
Share phones or office space with co-workers	Consider using: <ul style="list-style-type: none"> • Call Park to store and retrieve calls without using the transfer feature • Call Pickup to answer calls ringing on another phone • a shared line to view or join co-workers' calls • Cisco Extension Mobility to apply your phone number and user profile to a shared Cisco Unified IP Phone 	Ask your system administrator about these features and see the: <ul style="list-style-type: none"> • “Advanced Call Handling” section on page 29 • “Using a Shared Line” section on page 31 • Using the Extension Mobility Services” section in the document <i>Customizing Your Cisco Unified IP Phone on the Web</i>
Answer calls frequently or handle calls on someone's behalf	Ask your system administrator to set up the AutoAnswer feature for your phone.	See the “Using AutoAnswer with a Headset or the Speakerphone” section on page 37.

Troubleshooting Your Video Phone

This section provides troubleshooting information for your Cisco Unified IP Video Phone.

General Troubleshooting





This section provides information to help you troubleshoot general problems with your video phone. For more information, see your system administrator.

Symptom	Explanation
You cannot hear a dial tone or complete a call	One or more of the following factors might apply: <ul style="list-style-type: none">You must log into the Extension Mobility service.You must enter a client matter code or forced authorization code after dialing a number.Your phone has time-of-day restrictions that prevent you from using some features during certain hours of the day.
The Settings button is unresponsive	Your system administrator might have disabled  (settings button) on your phone.
The phone screen appears blank	The screen has gone into sleep mode to save power after a period of inactivity. Wake the screen by lifting the handset, or by pressing any button, such as  (volume button) .
The softkey that you want to use does not appear	One or more of the following factors might apply: <ul style="list-style-type: none">You must press more to reveal additional softkeys.You must change the line state (for example, go off-hook or have a connected call).Your phone is not configured to support the feature associated with that softkey.
Join fails	Join requires multiple selected calls. Be sure that you have selected at least one call in addition to the active call, which is selected automatically. Join also requires the selected calls to be on the same line. If necessary, transfer calls to one line before joining them.
Barge fails and results in a fast busy tone	You cannot barge an encrypted call if the phone you are using is not configured for encryption. When your barge attempt fails for this reason, your phone plays a fast busy tone.

Symptom	Explanation
You are disconnected from a call that you joined using Barge	You will be disconnected from a call that you have joined using Barge if the call is put on hold, transferred, or turned into a conference call.
Cisco CallBack fails	The other party might have call forwarding enabled.

Viewing Phone Administration Data

Your system administrator might ask you to access administration data on your video phone for troubleshooting purposes.

If you are asked to...	Then...
Access network configuration data	Choose  (settings button) > Network Configuration and select the network configuration item that you want to view.
Access status data	Choose  (settings button) > Status and select the status item that you want to view.
Access phone model information	Choose  (settings button) > Model Information .
Access call and quality information	Choose  (settings button) > Status > Call Statistics .

Using the Quality Reporting Tool

Your system administrator may temporarily configure your video phone with the Quality Reporting Tool (QRT) to troubleshoot performance problems. You can press **QRT** to submit information to your system administrator. Depending on configuration, use the QRT to:

- Immediately report an audio problem on a current call
- Select a general problem from a list of categories and choose reason codes

Cisco One-Year Limited Hardware Warranty Terms

There are special terms applicable to your hardware warranty and various services that you can use during the warranty period. Your formal Warranty Statement, including the warranties and license agreements applicable to Cisco software, is available on Cisco.com. Follow these steps to access and download the *Cisco Information Packet* and your warranty and license agreements from Cisco.com.

1. Launch your browser, and go to this URL:
http://www.cisco.com/univercd/cc/td/doc/es_inpkc/cetrans.htm
The Warranties and License Agreements page appears.
2. To read the *Cisco Information Packet*, follow these steps:
 - a. Click the **Information Packet Number** field, and make sure that the part number 78-5235-03A0 is highlighted.
 - b. Select the language in which you would like to read the document.
 - c. Click **Go**.
 - d. The Cisco Limited Warranty and Software License page from the Information Packet appears.
 - e. Read the document online, or click the **PDF** icon to download and print the document in Adobe Portable Document Format (PDF).



Note You must have Adobe Acrobat Reader to view and print PDF files. You can download the reader from Adobe's website: <http://www.adobe.com>

3. To read translated and localized warranty information about your product, follow these steps:
 - a. Enter this part number in the Warranty Document Number field: 78-10747-01C0
 - b. Select the language in which you would like to view the document.
 - c. Click **Go**.
The Cisco warranty page appears.
 - d. Read the document online, or click the **PDF** icon to download and print the document in Adobe Portable Document Format (PDF).

You can also contact the Cisco service and support website for assistance:

http://www.cisco.com/public/Support_root.shtml.

Duration of Hardware Warranty

One (1) Year

Replacement, Repair, or Refund Policy for Hardware

Cisco or its service center will use commercially reasonable efforts to ship a replacement part within ten (10) working days after receipt of a Return Materials Authorization (RMA) request. Actual delivery times can vary, depending on the customer location.

Cisco reserves the right to refund the purchase price as its exclusive warranty remedy.

To Receive a Return Materials Authorization (RMA) Number

Contact the company from whom you purchased the product. If you purchased the product directly from Cisco, contact your Cisco Sales and Service Representative.

Complete the information below, and keep it for reference.

Company product purchased from	
Company telephone number	
Product model number	
Product serial number	
Maintenance contract number	

Index

A

- alert tone **39**
- audio mute
 - Audio mute button **11**
 - using audio mute **23**
- AutoAnswer **37**

B

- brightness
 - Brightness button **11**
 - monitor brightness **39**

C

- call logs **40**
 - erasing **40**
 - viewing and dialing from **40**
- call overview **12**
- calls
 - answering calls **21**
 - call icons **16**
 - calls compared to lines **15**
 - calls on hold **16**
 - conference calls **26**
 - connected calls **16**
 - description **15**
 - ending calls **22**
 - forwarding calls **25**

- parked calls **34**
- prioritizing calls **34**
- redirecting calls **30**
- reporting problems with **49**
- selecting calls **17**
- shared line **16**
- supported numbers **15**
- switching among calls **17**
- tracing suspicious calls **34**
- transferring calls **24**
- camera
 - adjust the camera **19**
 - camera brightness **19**
 - camera lens cap docking **10**
 - description of the camera **9**
 - focus **19**
 - tilt **19**
- Cancel button **11**
- cBarge **27**
- CFwdALL **25**
- checkmark **17**
- Cisco Unified IP Video Phone
 - connecting cables **6**
 - documentation **2**
 - keypad **10**
 - overview **8**
 - troubleshooting **48**
- conference
 - conference calls **26**
 - joining a conference **26**
 - meet-me conference call **28**
 - starting a conference **26**
- ConfList **27**

Confrn **26**

D

dialing **19**

directories

- Directories button **12**

- feature menu **14**

- using directories **40**

directory

- using on phone **40**

DirTrfr **24**

Display button **10**

documentation, accessing **2**

duration **12**

E

external devices **4**

F

feature buttons **18**

feature menu **18**

feature, availability **14**

forwarding calls **25**

H

handset

- description **9**

- mounting the handset bracket **7**

- plug for handset **6**

headset

- AutoAnswer **37**

- Headset button **11**

- plug for headset **6**

- using headset **36**

help

- feature menu **14**

- getting help **14**

- Help button **11**

hold

- hold icon **16**

- using hold **22**

I

ID **12**

J

Join **26**

K

keypad

- buttons **10**

- description **10**

L

LCD monior **9**

Letter buttons **11**

Line button **10**

lines

compared to calls **15**
description **15**

M

MCID **34**

Meet-Me **28**

messages

feature menu **14**

indicator for **43**

listening to **43**

Messages button **11**

microphone **9**

missed calls, records of **40**

N

Navigation button **11**

network cable

PC port **6**

SW port **6**

network configuration data, locating **48**

Notification lamp **10**

Number buttons **11**

O

off-hook

compared to on-hook **16**

description **16**

off-hook icon **16**

on-hook

compared to off-hook **16**

description **16**

on-hook icon **16**

options

configuration options **46**

P

parked calls **34**

Picture in Picture (PiP)

displaying outgoing video picture **23**

PiP button **11**

placed calls, records of **40**

power cable **6**

precedence **34**

preemption **35**

primary line **12**

prioritizing calls **34**

Q

QRT, using **49**

R

received calls, records of **40**

redirecting calls **30**

resume **22**

ringing icon **16**

S

safety **3**

screen

- LCD monitor **9**
- screen layout **12**
- selecting calls **17**
- selfview
 - displaying outgoing video picture **23**
 - Selfview button **11**
- services
 - feature menu **14**
 - Services button **11**
- settings
 - feature menu **14**
 - phone settings **38**
 - Settings button **12**
- shared line **31**
 - adding yourself **32**
 - preventing others from joining **33**
 - preventing others from viewing **33**
- shared line icon **16**
- softkeys **11**
- speaker
 - AutoAnswer **37**
 - description **10**
 - Speaker button **11**
 - using speakerphone **36**
- speed dial numbers **29**
- status data, locating **48**

T

- telephone call **22**
- text **14**
- tracing calls **34**
- Transfer **24**

- transferring calls **24**
- troubleshooting **48**

V

- video call
 - answering calls **21**
 - before you make a video call **19**
 - ending a video call **22**
 - placing a video call **19**
- video mute
 - using video mute **23**
 - Video mute button **12**
- video picture
 - displaying outgoing video picture **23**
 - see your video picture **19**
- voice message **40**
- voice message indicator **43**
- voice message service **43**
- volume
 - adjusting volume **38**
 - volume button **12**

W

- warnings **3**

CISCO SYSTEMS



Corporate Headquarters
Cisco Systems, Inc.
170 West Tasman Drive
San Jose, CA 95134-1706
USA

www.cisco.com
Tel: 408 526-4000
800 553-NETS (6387)
Fax: 408 526-4100

European Headquarters
Cisco Systems International BV
Haarlerbergpark
Haarlerbergweg 13-19
1101 CH Amsterdam
The Netherlands
www-europe.cisco.com
Tel: 31 0 20 357 1000
Fax: 31 0 20 357 1100

Americas Headquarters
Cisco Systems, Inc.
170 West Tasman Drive
San Jose, CA 95134-1706
USA
www.cisco.com
Tel: 408 526-7660
Fax: 408 527-0883

Asia Pacific Headquarters
Cisco Systems, Inc.
Capital Tower
168 Robinson Road
#22-01 to #29-01
Singapore 068912
www.cisco.com
Tel: +65 6317 7777
Fax: +65 6317 7799

Cisco Systems has more than 200 offices in the following countries. Addresses, phone numbers, and fax numbers are listed on the **Cisco Website at www.cisco.com/go/offices**

Argentina • Australia • Austria • Belgium • Brazil • Bulgaria • Canada • Chile • China PRC • Colombia • Costa Rica • Croatia • Czech Republic • Denmark • Dubai, UAE
Finland • France • Germany • Greece • Hong Kong SAR • Hungary • India • Indonesia • Ireland • Israel • Italy • Japan • Korea • Luxembourg • Malaysia • Mexico
The Netherlands • New Zealand • Norway • Peru • Philippines • Poland • Portugal • Puerto Rico • Romania • Russia • Saudi Arabia • Scotland • Singapore • Slovakia
Slovenia • South Africa • Spain • Sweden • Switzerland • Taiwan • Thailand • Turkey • Ukraine • United Kingdom • United States • Venezuela • Vietnam • Zimbabwe

CCSP, CCVP, the Cisco Square Bridge logo, Follow Me Browsing, and StackWise are trademarks of Cisco Systems, Inc.; Changing the Way We Work, Live, Play, and Learn, and iQuick Study are service marks of Cisco Systems, Inc.; and Access Registrar, Aironet, ASIST, BPX, Catalyst, CCDA, CCDP, CCIE, CCIP, CCNA, CCNP, Cisco, the Cisco Certified Internetwork Expert logo, Cisco IOS, Cisco Press, Cisco Systems, Cisco Systems Capital, the Cisco Systems logo, Cisco Unity, Empowering the Internet Generation, Enterprise/Solver, EtherChannel, EtherFast, EtherSwitch, Fast Step, FormShare, GigaDrive, GigaStack, HomeLink, Internet Quotient, IOS, IP/TV, iQ Expertise, the iQ logo, iQ Net Readiness Scorecard, LightStream, Linksys, MeetingPlace, MGX, the Networkers logo, Networking Academy, Network Registrar, Packet, PIX, Post-Routing, Pre-Routing, ProConnect, RateMUX, ScriptShare, SlideCast, SMARTnet, StrataView Plus, TeleRouter, The Fastest Way to Increase Your Internet Quotient, and TransPath are registered trademarks of Cisco Systems, Inc. and/or its affiliates in the United States and certain other countries.

All other trademarks mentioned in this document or Website are the property of their respective owners. The use of the word partner does not imply a partnership relationship between Cisco and any other company. (0502R)

© 2006 Cisco Systems, Inc. All rights reserved.

♻️ Printed in the USA on recycled paper containing 10% postconsumer waste.



78-16798-02



78-16798-02