

How to attach the Leaves

Step 7

- Measure an approximately 14 inch (36cm) piece of stem wrap using the ruler guide on the last page.
- Start wrapping the stem wrap tightly around the stem, near the top as shown. A couple of turns should be enough.
- Then join the Leaves to the side of the flower as shown above.
- Continue wrapping the stem wrap until the stem is completely covered. Secure the paper to the bottom of stem with a small piece of clear tape (not included).

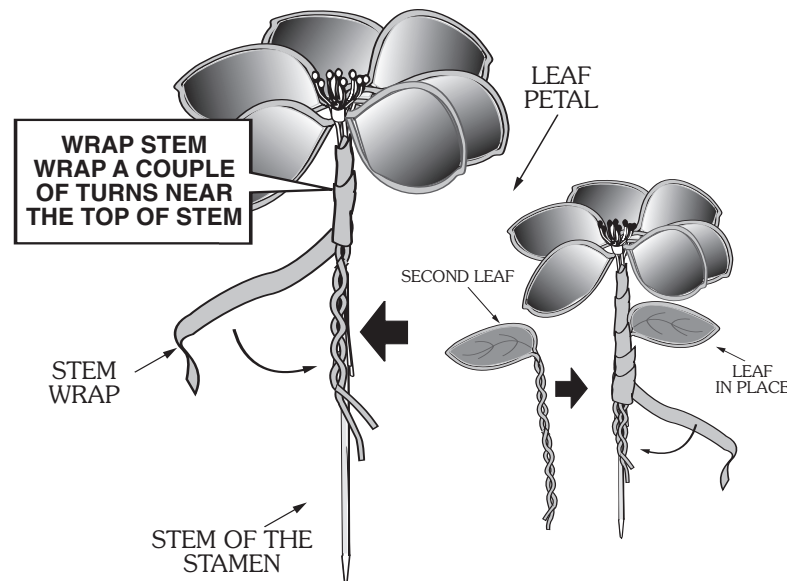

How to Display your Flowers

1. Locate your flower pot and foam.
2. Snap together the two sides of the flower pot.
3. Put your foam in the base of the flower pot.
4. Put flower stems into foam and arrange.

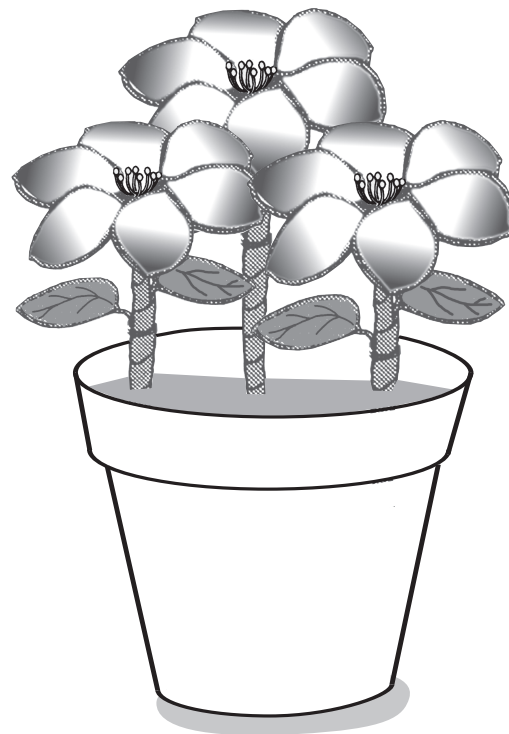

Visit our website: www.nsi-int.com

Ages 6 and up

Conforms to ASTM-D4236
No. 1959-08-A

Make Your Own Pretty Petals® Scented Flower Maker

WARNING:
CHOKING HAZARD-Small parts.
Not for children under 3 years.

Dear Customer,

We hope you enjoy your Pretty Petals®. If you find that we have made an error or if something is missing or damaged, let us know so that we can correct the problem for you. Please include the following information:

- Name of item
- Date of Purchase
- Purchase Price (please include sales slip)
- Model number
- Place of Purchase
- Brief description of the problem

Do not return the kit to the store where you purchased it, they will not have the replacement parts!

Send all correspondence to: **NSI International, Inc.**

**105 Price Parkway
Farmingdale, NY 11735-1318**

Attn: Quality Control Department

You may call us at (631)501-7550

Your set contains the following items:

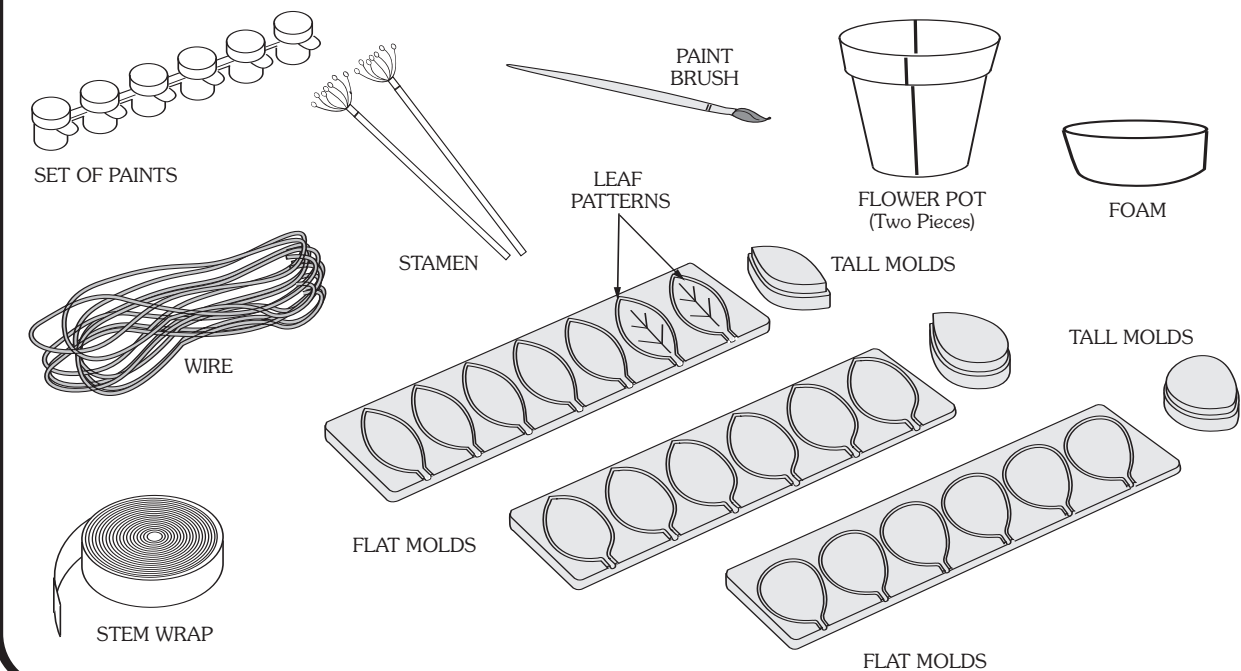

Preparation

Step 1

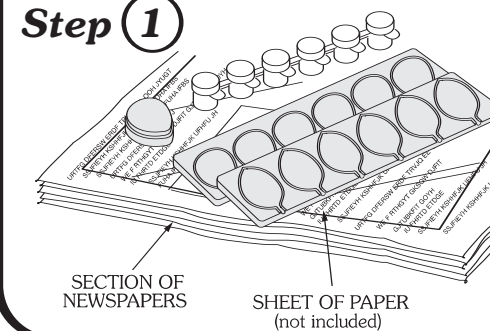

BEFORE STARTING: We strongly recommend organizing your supplies away from carpeting and upholstery on a suitable working area such as a kitchen table with a sink nearby. Place everything on sections of paper for quick and easy cleanup.

- Keep paper towels or napkins handy for wiping the paintbrush clean after washing. Have a cup of water handy for rinsing your paintbrush.
- Take precautions against spills. Cover your work surface and wear old clothing or smock.
- The paints in this set are very high quality, non toxic, and may permanently stain fabrics, clothing, furniture and carpeting.

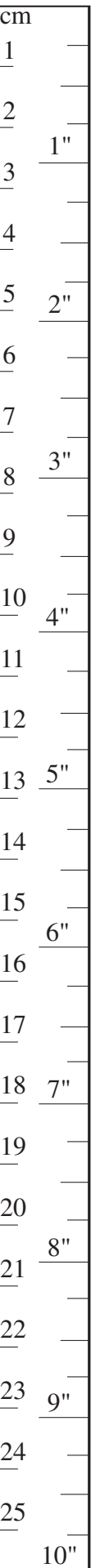

How to Shape Wires into Petals and Leaves

Step ②

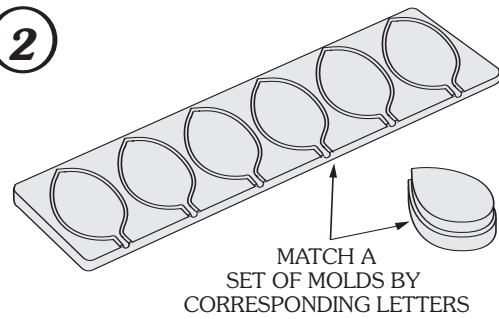

- A.** Locate and match one of the Flat Molds to one of the Tall Molds by the same letters; For example: A to A, B to B and C to C.
- B.** Next cut a piece of colored wire off the wire bunch, approximately 8 inches (20 cm) in length.
- Note:** Use the printed ruler on the last page as a guide to cut the wire to the correct size.

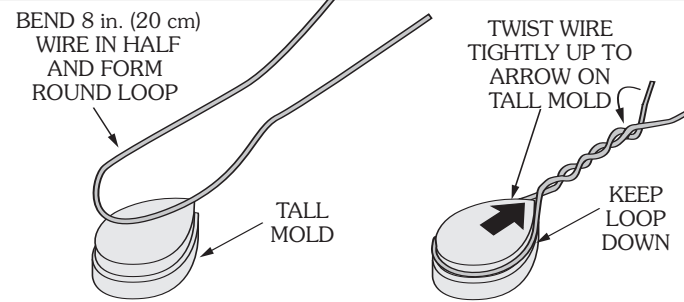

- A.** Bend the Wire in half and form a loop.
- B.** Place the Loop end of Wire around top area of the Tall Mold.
- C.** Keep the loop down on Mold as you twist the ends of wires tightly all the way up to the arrow on Tall Mold as shown above.
- Note:** The arrow points to the end of the mold where the wires should twist.

How to Shape Wire in Flat Mold

Step ③

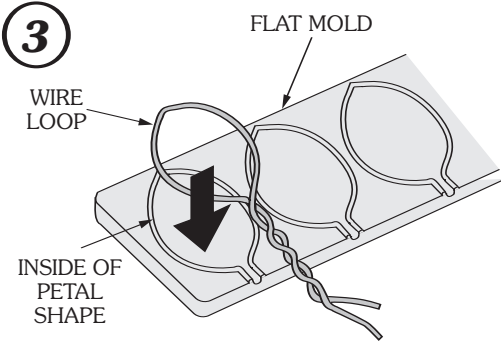

- A.** Place the Wire Loop on top of one of the petal shapes on the Mold as shown.
- Note:** Make sure the wire fits as close as possible along the inside shape of petal.

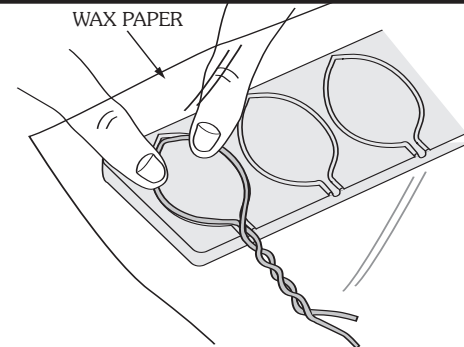

- B.** Once Wire Loop is in position use your fingers to push wire into the grooved area along the inside of the petal shape until it stays in place.
- C.** Form the remaining petals on the Mold in the same manner and make sure they are in place.

How to Make the Petals and Leaves

Step ④

We advise including two leaves for each flower of five or six petals.

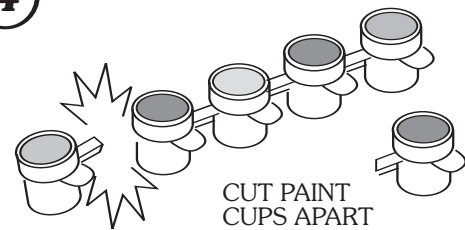

- A.** Next cut the Cups of paint apart using a pair of household scissors, with adult supervision.
- B.** Dip your brush into any cup of paint and apply a **good thick coat** of paint into the open area, inside the Wire Loop as shown at right.
- C.** Use as many different colors as you wish to make the various petals but don't mix wet colors together or petal may become muddy looking.

NOTE: Allow to dry thoroughly, approximately 8-12 hours or for best results, overnight.

PAINT MUST TOUCH and COVER WIRE LOOPS COMPLETELY

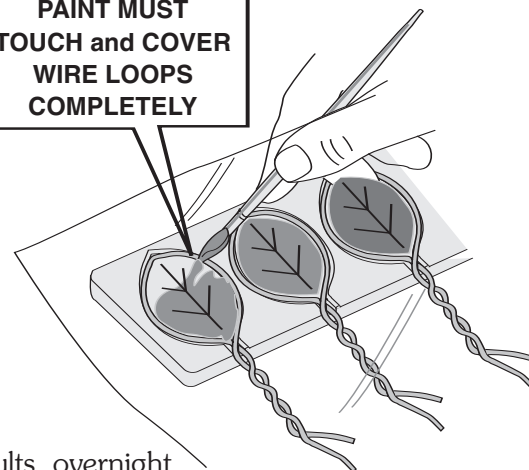

How to Peel the Petals off the Mold

Step ⑤

After waiting approximately 8-12 hours for the paints to dry, carefully lift up the Petals as explained below.

- A.** Slowly and carefully lift the petals from the mold by lifting the wire stems upward.
- B.** As you remove the petals from the mold, place them on the wax paper so they do not touch.
- Note:** If film separates from wire, put it back in mold and cover with paint again. Let dry and lift up again.

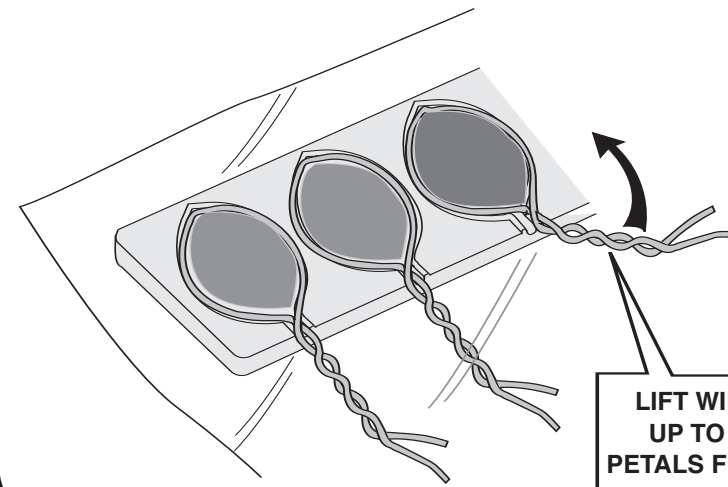

MAKING TINY PETALS

Added Note: You can also make tiny petals, no more than 1/4 inch (1/2 cm) in diameter, by hand twisting a petal shape and dropping it into a paint cup. Let dry on wax paper. You can twist the wire around a pencil for the proper size.

1/4 INCH (1/2 cm) DIAMETER PETAL

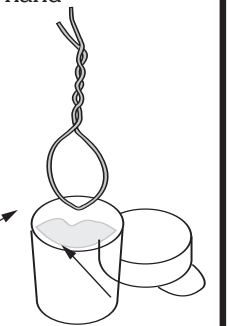

How to start making your Flower

Step ⑥

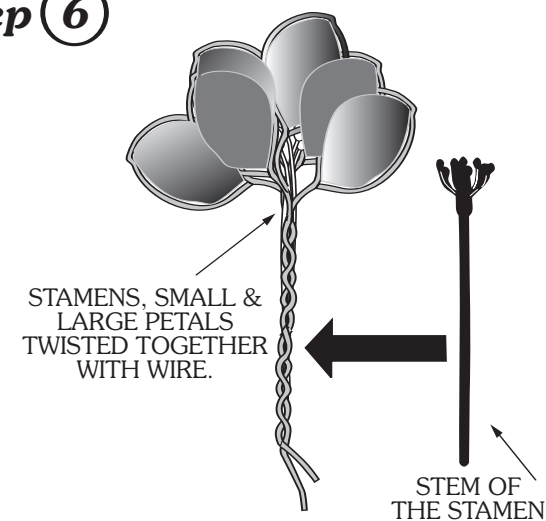

- A.** Gather the Petals you just made, the Stamen and twist together at the stems.
- B.** Twist all the wire stems around the stem of the stamen until they are joined together.
- Note:** We suggest making 6 petals and two leaves per flower. Tiny petals (Step 6) look pretty around the Stamens.

PLACE STAMEN IN THE MIDDLE OF FLOWER

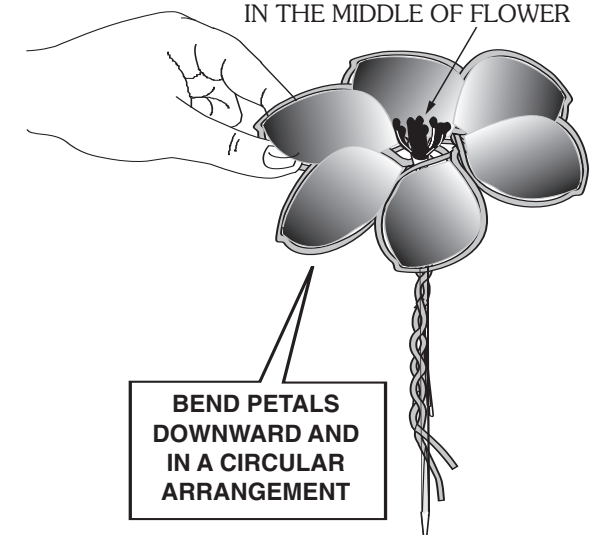

- C.** After the stems of the Petals and Stamens are twisted together, carefully bend the petals downward and apart from each other.
- Note:** Arrange Petals in a circular pattern with Stamens positioned in the middle of the petals as shown. You can shape petals by gently bending or pinching wire to your liking.