

VERSAGATE (Model VG-65)

FOR DOOR AND STAIRWELL SAFETY, ROOM DIVIDER, RETAINING GATE, OR PLAYPEN ENCLOSURE.

ASSEMBLY INSTRUCTIONS

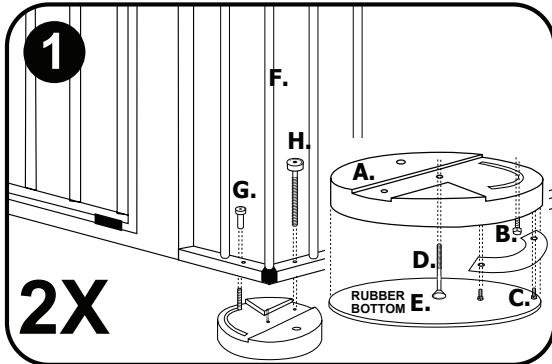
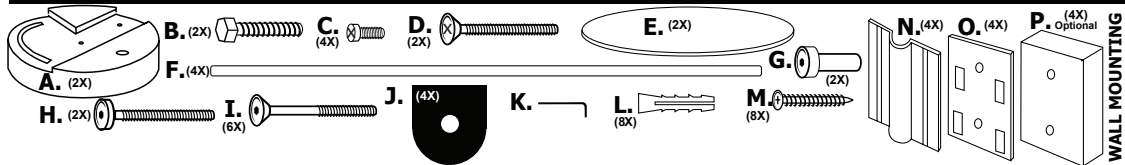

FOR GREATER PROTECTION BUILD GATE WITH RED OPENING BUTTON AWAY FROM CHILD.

- Assemble round feet (**A**) first. Thread bolt B through crescent shape threads up Cover opening with crescent plate with screws C Thread bolt D through middle of foot Cover foot assembly with rubber bottom E
- Connect Extension to gate Place gate together with extension (holes in gate and extension should be on bottom) Thread rod F into screw D Secure foot to gate with screw cap G into screw B Secure extension to foot with screw H

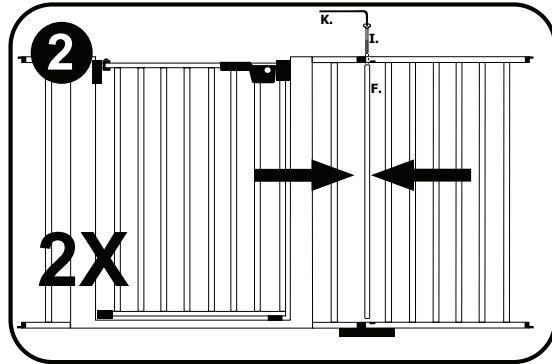

Secure upper part of rod (**F**) to gate using screw (**I**).

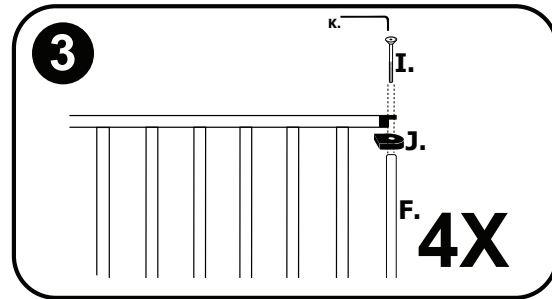

3. Attach end rods (**F**) to ends of extensions and add end caps (**J**) with long bolt (**I**). Repeat at each corner of extensions.

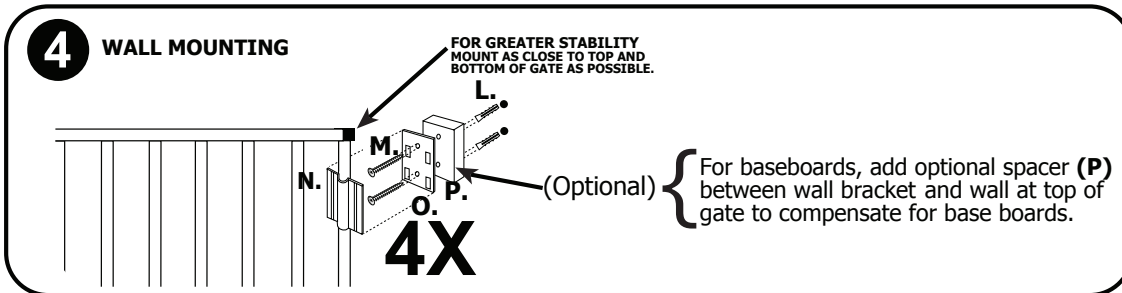

5. Insert screw anchor (**L**), if necessary, and attach wall bracket (**O**) with screw (**M**). Attach gate to wall with removable (**N**) clip (until a click sound is heard).

GATE OPERATION

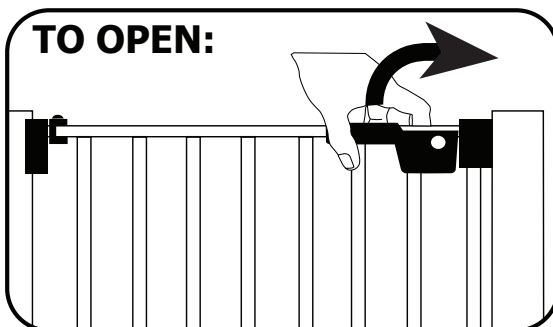

Push red safety button and lift handle 90° upwards. Pull gate to open.

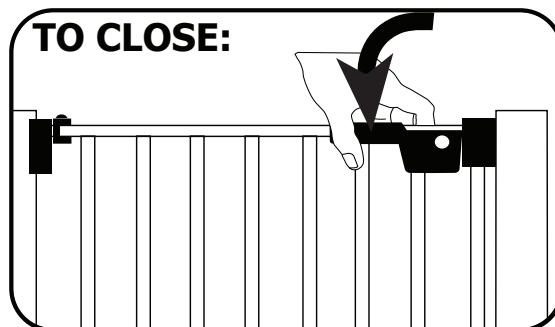

Close gate and lower handle back to original position. Gate will click when locked.

GATE MAINTENANCE

To clean, rinse with lukewarm water, wash gently with mild soap or detergent and lukewarm water, using a soft cloth or sponge. Rinse again. Dry with a soft cloth or sponge to prevent water spotting. DO NOT SCRUB or use brushes or squeegees.

GATE CARE & REMINDERS

Our gates are built to last many years with proper use and care. Here are a few suggestions...

- Close gates gently - do not slam - to prevent damage to latch mechanism.
- When closing, be sure safety bracket on gate frame engages as depicted in instructions.
- For safety, always close gate when not in use. Children should not be allowed to swing on an open gate as this can damage hinge mount.
- Periodically check all screws, bolts, etc. for security and proper adjustment.

CARDINAL GATES, INC., offers many accessories such as extensions, stair kits, and other safety products. Check with your dealer or call **CARDINAL GATES, INC.** at 1-800-318-3380.

We sincerely hope that you thoroughly enjoy many years of service from your **CARDINAL GATE**.

GATE WARRANTY

Your Cardinal Gate is warranted to be free of manufacturing defects for a period of one year from the date of purchase when used in homes, and according to manufacturers instructions. When used commercially, such as day care centers, the warranty is 90 days.

Cardinal Gates, Inc. will either repair or replace, at our option, any parts necessary to correct defects in material or workmanship during the warranty period. The warranty disclaims liability for incidental, special and consequential damages of any nature.

TO EXERCISE WARRANTY:

Ship your gate in a protective carton, freight prepaid to:
CARDINAL GATES, INC.
79 Amlajack Way
Newnan, GA 30265

You must include the following:

1. Proof of purchase (store receipt, etc.).
2. Brief note describing problem with gate.
3. Full return address along with phone number.

FOR FURTHER ASSISTANCE

Call 1-800-318-3380

CARDINAL GATES

If it's a Cardinal, It's the Best!

79 Amlajack Way
Newnan, GA 30265
770-252-4200
www.cardinalgates.com



WARNING: TO PREVENT SERIOUS INJURY OR DEATH, SECURELY INSTALL GATE OR ENCLOSURE AND USE ACCORDING TO MANUFACTURER'S INSTRUCTIONS. NEVER USE WITH A CHILD ABLE TO CLIMB OVER OR DISLodge/OPE THE GATE ENCLOSURE. NEVER LEAVE CHILD UNATTENDED. USE ONLY WITH THE LOCKING/LATCHING MECHANISM SECURELY ENGAGED.



MISE EN GARDE: INSTALLER CONFORMÉMENT AUX INSTRUCTIONS DU FABRICANT. DESTINE AUX ENFANTS DE 6 À 24 MOIS. CET ARTICLE NE PRÉVIENT PAS NÉCESSAIREMENT TOUS LES ACCIDENTS. NE JAMAIS LAISSER L'ENFANT SANS SURVEILLANCE.