

How To Install SIMONIS Cloth

PLAY SIDE - To determine the play side of SIMONIS cloth, look for the name **IWAN SIMONIS** on the selvedge (side). This is the "up" or "play" side. You can also tell the play side by its very smooth, napless surface.

RAIL CLOTH

- If 78" wide cloth is used, cut rails from the side as shown.

- If 64" wide cloth is used, rails may be cut from the side or end.

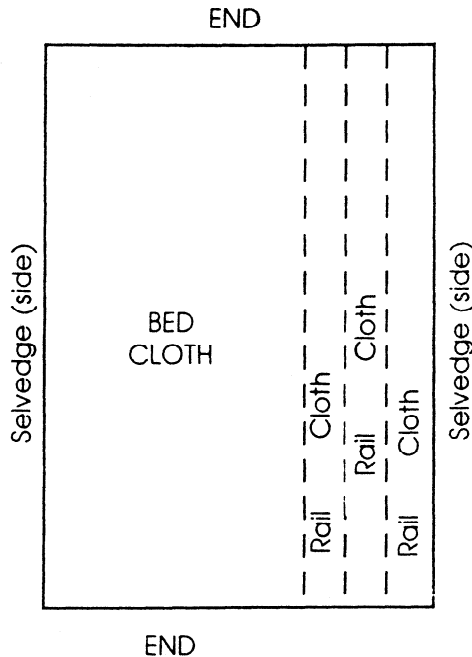

A.

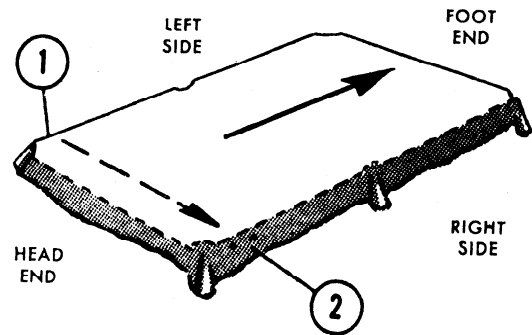

1. Lay the bed cloth over top of slate, play side up. Leave only enough cloth at head end and left side to permit tacking, leaving balance of the cloth overhanging on the foot end and right side. Staple cloth securely to slate frame at (1) with 4 staples approximately 1" apart.

2. Stretch cloth across the table and staple securely at (2) again using 4 staples as indicated above.

(Four staples recommended for hard stretch.)

B.

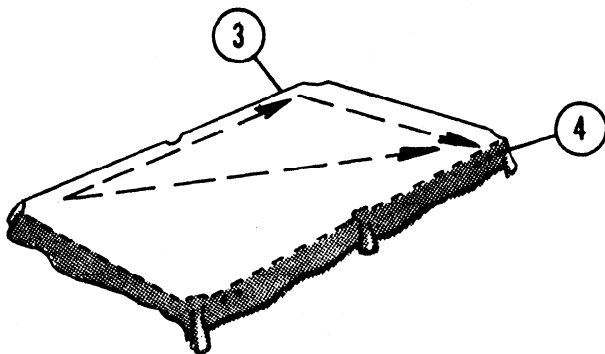

3. Stretch cloth from (1) to (3) and tack securely, maintaining proper margin on left side of table.

4. Stretching cloth across table from (3) and pulling from (2), tack cloth at (4).

C.

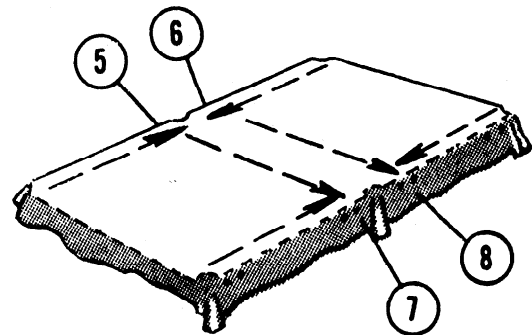

5. On left side, stretch cloth tightly from (1) toward side pocket opening and tack securely at (5).

6. Repeat operation 5, stretching cloth from (3) and tacking at (6).

7. On right side of table, grasp cloth firmly, stretch across table from (5) and toward side pocket from (2) and tack at (7).

8. Repeat operation 7, stretching from (6) and toward side pocket from (4) and tack at (8).

D.

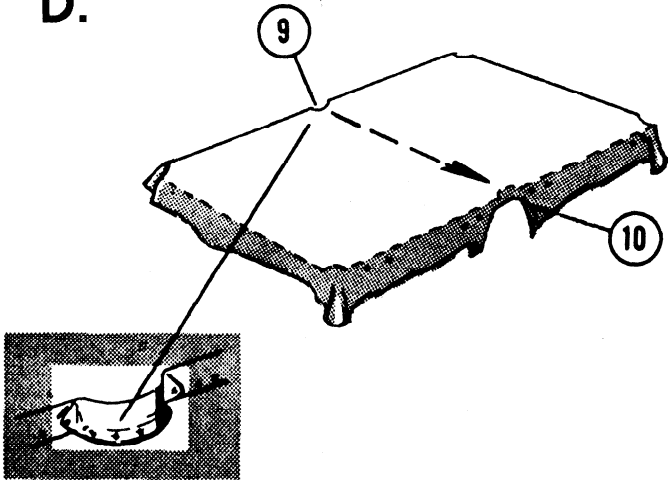

9. At (9), cut a short slit in cloth at edge centered with side pocket opening. Grasp cloth firmly above this slit, pull cloth into side pocket opening and tack to undercut of slate frame. Complete tacking of cloth to side pocket opening, making sure that cloth is tacked to undercut of slate frame.

10. Stretching cloth tightly across the table from (9) repeat the above operation at (10). Be sure to tack cloth to undercut of slate frame.

E.

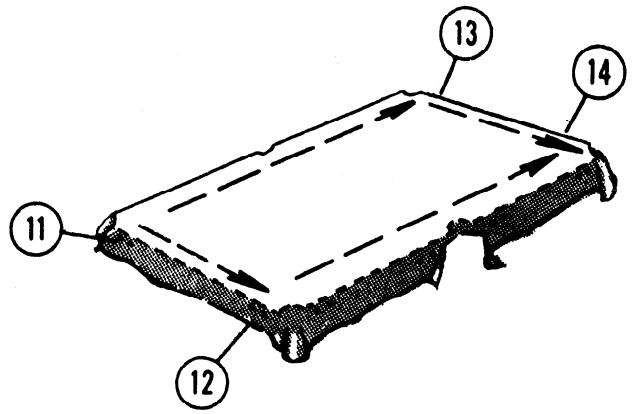

11. At Head End of table, tack cloth at (11), holding to proper margin.

12. Pull cloth from (11) toward (12) and tack securely, holding proper margin.

13. Stretch cloth firmly from (11) to Foot End of table and tack at (13).

14. Stretch cloth tightly from (12) and (13) toward (14) and tack securely.

F.

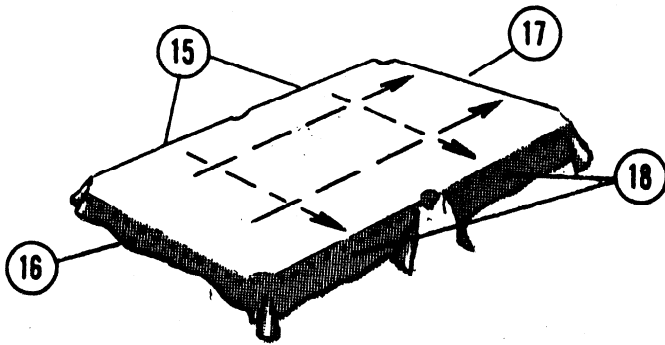

15. Tack all of Left Side on 3" centers holding to proper margin.

16. Tack balance of Head End on 3" centers holding to proper margin.

17. Stretch cloth tightly toward Foot End of table, tacking on 3" centers all the way across.

18. Stretch cloth tightly across table to Right Side, tacking on 3" centers all the way across.

G.

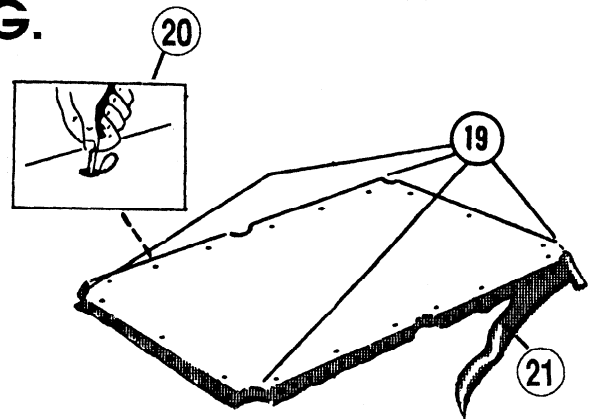

19. Stretch cloth into corner pocket openings and tack to undercut of slate frame.

20. Cut holes in cloth at rail bolt locations.

21. Trim off excess cloth with a sharp knife.

NOTE: When installing cloth on carom tables, eliminate operations No. 5, 6, 7, 8, 9, 10, and 19. Otherwise follow same procedure as outlined above. Occasionally cloth will stretch, leaving wrinkles at the pockets. To re-tighten, remove only one end rail and one side rail. Pull cloth taut, and re-tack along the open end and side to restore original tightness.

Fran Simonis

800-SIMONIS (746-6647)

CUSHION CLOTH REPLACEMENT

1. PREPARE RAILS

Remove rails from table.

Carefully remove old feather strips and save for re-use.

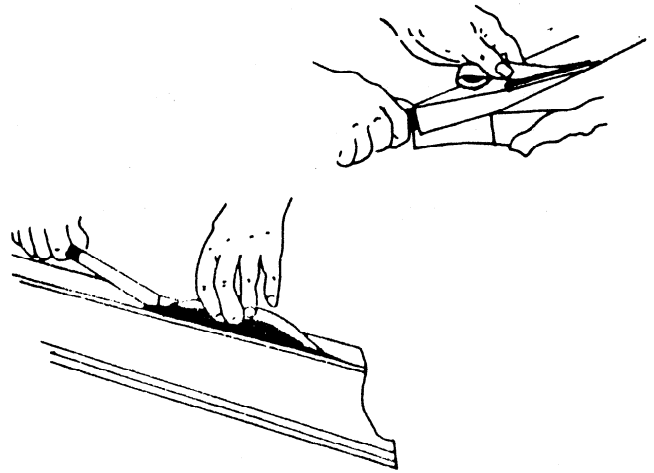

2. INSTALL FEATHER STRIPS

- A. With rail face up, place new cloth on rail with playing surface down. Center cloth on rail, with approximately 4" of cloth at each end and 1/2" of cloth beyond the feather strip slot.

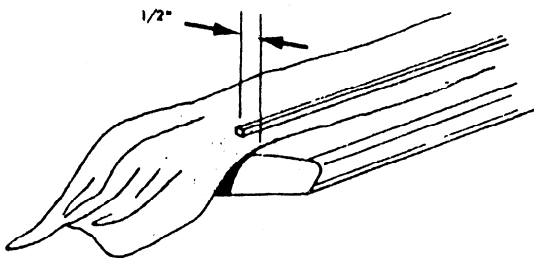

- B. For corner pockets, tap feather strip in place except for 3" at each end. Start approximately 2" from end of feather strip and pull cloth toward rubber cushion until the edge of the cloth is approximately 3/4" from the end of the feather strip. Tap feather strip in place.

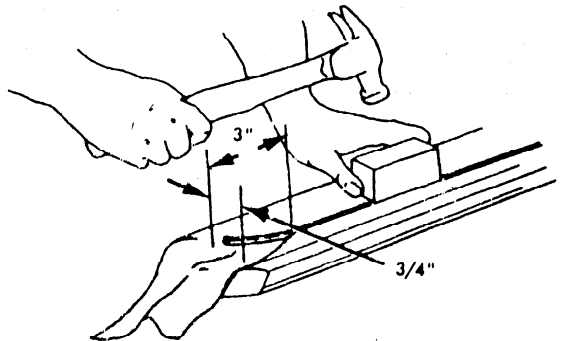

- C. For side pockets, start approximately 3" from end of rail and pull cloth toward rubber cushion until the edge of the cloth is approximately 1/2" from the end of the feather strip. Tap feather strip in place.

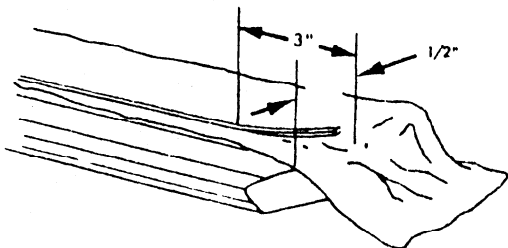

- D. Pull cloth tight and tap feather strip in place, then trim cloth along cushion side of feather strip. Fold cloth over cushion and tap full length of feather strip flush with rail cap.

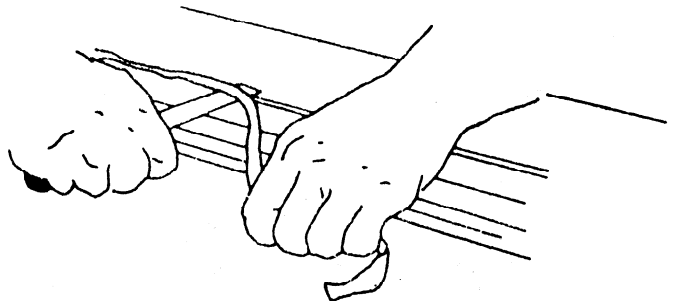

NOTE: IF FEATHER STRIPS ARE LOOSE ADD A STRIP OF MASKING TAPE THE FULL LENGTH OF STRIP.

3. STAPLE CLOTH

- A. Pull cloth tightly downward and staple with four staples along bottom of rail. Pull cloth tightly over end of rail and staple with three staples in groove back of cushion reinforcing pad.

corner pockets

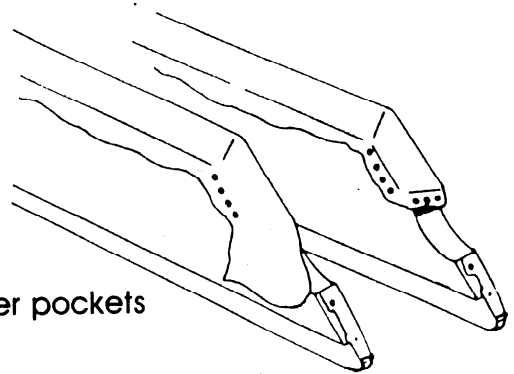

- B. For side pockets, stretch cloth firmly over nose of cushion toward the bottom without distorting cushion shape. **Pull cloth tightly toward side pocket before tacking.** Staple cloth to rail bottom approximately 1" from pocket opening.

side pockets

B.

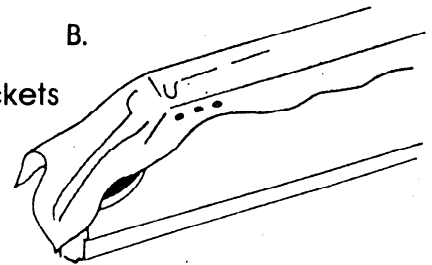

- C. Snip cloth at nose and pull small strip down to groove. Staple in place as shown. Then snip (or fold) excess cloth leaving enough for small fold at the top as shown.

C.

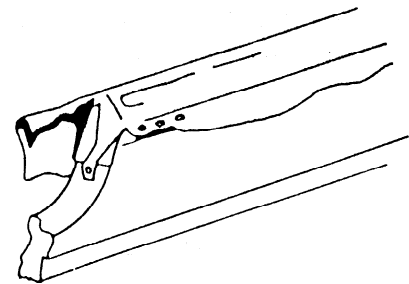

- D. Hold small fold at top in place, then fold entire piece over. Staple at bottom of rail and at groove with three staples each. Stretch balance of cloth tightly over cushion and staple at bottom of rail, starting at the center, and working toward the ends. Space staples about 1" apart. Be sure cloth is snug, but not tight enough to alter shape of the cushion.

D.

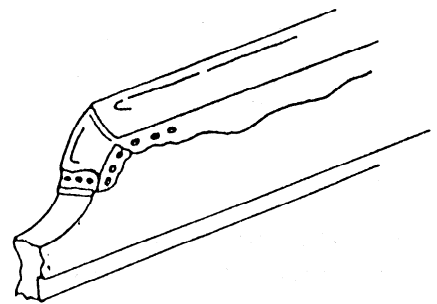

- E. Trim excess cloth from rail. Be sure at least 1/4" of cloth remains after trimming.

E.

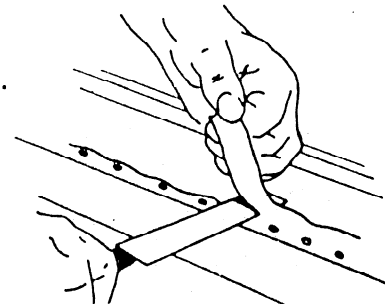

Frank Simonis

800-SIMONIS (746-6647)