

**MARSH SOUND DESIGN**

O P E R A T I N G M A N U A L

Power amplifier **A200S**

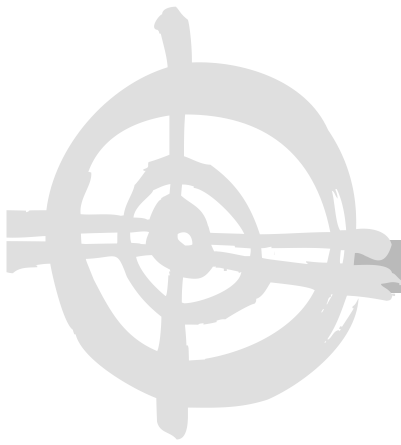

Warning

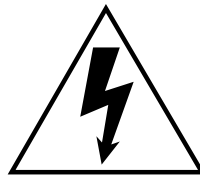

The lightning flash with arrowhead, within an equilateral triangle, is intended to alert the user to the presence of uninsulated “dangerous voltage” within the product’s enclosure that may be of sufficient magnitude to constitute a risk of electric shock to people.

**CAUTION**  
**RISK OF ELECTRIC SHOCK**  
**DO NOT OPEN**

**CAUTION:**

To prevent the risk of electric shock, do not remove the cover (or back) . No user-serviceable parts inside. Refer servicing to qualified service personnel.



The exclamation point within an equilateral triangle is intended to alert the user to the presence of important operating and maintenance instructions in the literature accompanying the appliance

**WARNING: TO PREVENT FIRE OR SHOCK HAZARD, DO NOT OPEN OR EXPOSE THIS APPLIANCE TO RAIN OR MOISTURE.**

**Before proceeding with the installation, please read the instructions carefully and completely. If you have any problems, do not hesitate to contact your retailer or our Service Department.**

- 1. All warnings on the unit and in the operating manual should be followed.**
- 2. Operate the unit only from a power source of the appropriate voltage indicated on the rear panel.**
- 3. Do not use a damaged or deformed power cord as it may cause electric shock. When removing the plug from the wall outlet, be sure to remove by holding the plug attachment and not by pulling the cord.**
- 4. This unit should not be used near water or in humid conditions.**
- 5. Do not pour or spill liquids of any kind onto this unit.**
- 6. Do not operate this product with any cover removed.**
- 7. Before connecting or disconnecting any cables, always turn off your equipment and disconnect your entire system from the AC mains.**
- 8. Do not replace any fuse with a value or type other than that specified.**
- 9. Do not overload the wall outlet or extension cord because this can result in a risk of fire or electric shock.**
- 10. Do not push objects of any kind into this product through the openings e.g., ventilation slots, because they may touch dangerous voltage points or short-out parts. This act could result in a fire or electric shock.**
- 11. Do not attempt to repair this product because opening or removing covers may expose you to dangerous voltage or other hazards. If a problem occurs, contact your Marsh retailer.**
- 12. Disconnect your entire system from the AC mains before cleaning.**
- 13. Slots and openings in the cabinet are provided for ventilation and to ensure reliable operation of this product and to protect it from overheating. These openings must not be blocked or covered.**
- 14. The operating temperature ranges from +5 to +35 degrees C. Operating humidity ranges from 5% to 80%. Do not operate the unit when the temperature and/or humidity are outside of this range.**

***Thank You*** for purchasing the MARSH SOUND DESIGN MSD-A200S.  
MSD brings you extraordinary components that are true, above all, to the art of music.

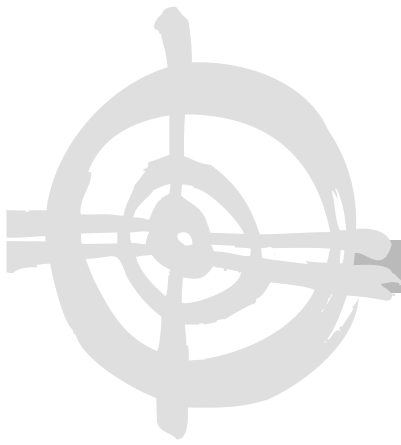

## Table of Contents

<b>Important/Precautions.....</b>	<b>2</b>
<b>Preface.....</b>	<b>6</b>
<b>Unpacking.....</b>	<b>8</b>
<b>Placement Considerations.....</b>	<b>9</b>
<b>Functions.....</b>	<b>10</b>
<b>Connections.....</b>	<b>11</b>
<b>Internal Protections.....</b>	<b>12</b>
<b>Troubleshooting guide.....</b>	<b>13</b>
<b>Care &amp; Maintenance.....</b>	<b>14</b>
<b>Warranty information.....</b>	<b>15</b>
<b>Specifications.....</b>	<b>16</b>
<b>Dimensions.....</b>	<b>17</b>



**M**SD's logo comes from an ancient Native American petroglyph pecked in stone, high in the Sierra Nevada mountain range. Long ago, small, self-sufficient groups of people moved about the mountains, hunting and gathering, and celebrating rituals. Leaving behind little about themselves, except for these rock figures and a few stone tools. The mark we found, created a thousand years ago, could have been a sun sign, a map, or a symbol of focus and concentration-or yet some mystery we cannot imagine today.

**J**ust as a great performer spends years learning his or her instruments, so a master designer spends years understanding the complexities of audio circuitry and the science of electronics.

For more than 30 years, *Richard N. Marsh*, author, lecturer, engineer, and inventor, has shared the art of perfecting audio circuits with other designers. Now, his goal is to bring you his accumulated experience in the service of music.

The Marsh Sound Design team builds its products to the most exacting standards of design and construction, for simplicity of use, long life and timeless performance. Your investment in a Marsh product means that you can forget about the hardware and focus on years of enjoyment.

**So - set your course for the music . . .and leave the rest to us.**

### **The MSD-A200S**

The A200S gives out 120 watts per channel, for a total of 240 watts. The A200S is designed with a High End circuit with very low-noise FETs. A balanced, complimentary differential input circuit makes the A200S even more linear than other systems.

Complex? Yes, but elegant and effective. The output stage has two pairs of high current, paralleled, bi-polar power transistors to meet the peak current demands of any speaker system. Dynamic transient sounds come through with full impact and clarity. Servo-controlled, direct-coupled circuitry is used throughout the circuitry for extremely high resolution sound.

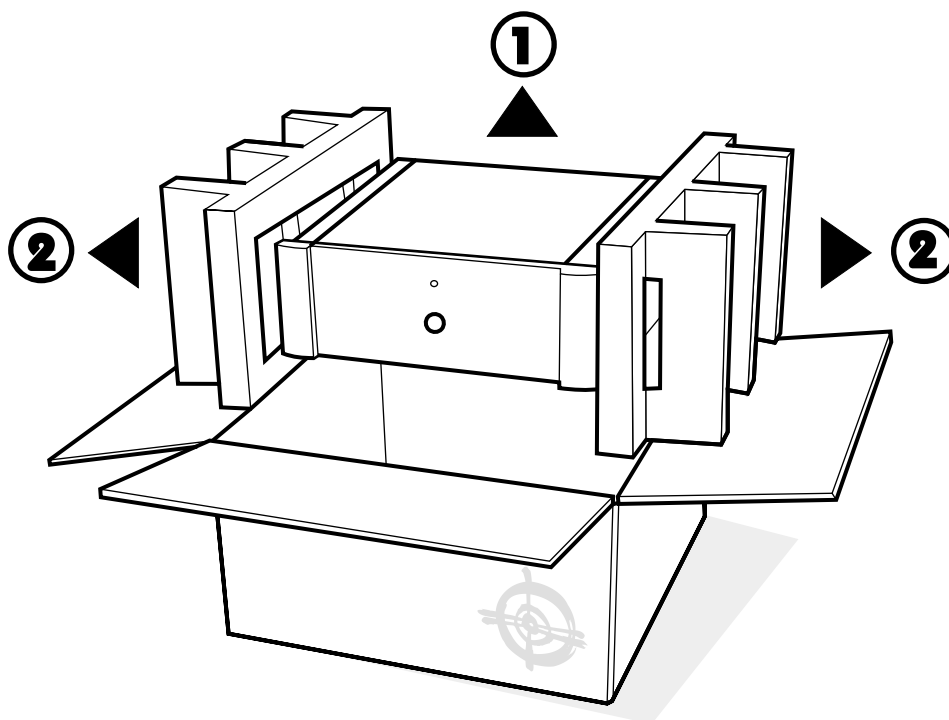
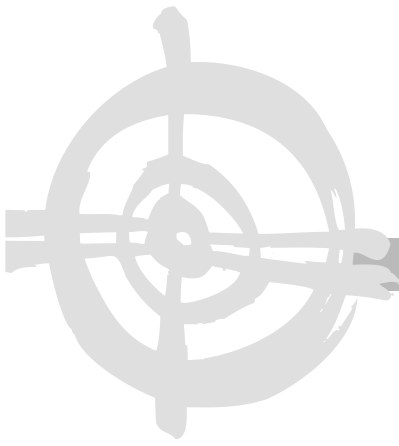

**WARNING: PEOPLE WITH BACK PROBLEMS SHOULD NOT UNPACK THIS EQUIPMENT WITHOUT ASSISTANCE.**

1. Carefully lift the unit out of the box.
2. Remove the foam packing material.
3. Set up the unit for use.

**REMEMBER:** *Keep all the original packing in case it is necessary to return the unit for servicing.*



## Placement Considerations

**DO NOT** INSTALL THE UNIT IN THE FOLLOWING LOCATION:

1. In a place subject to direct sunlight.
2. In a humid place.
3. In an extremely hot or cold place.
4. In a place subject to vibrations.
5. In a dusty place.
6. In a poorly ventilated place.



## Functions

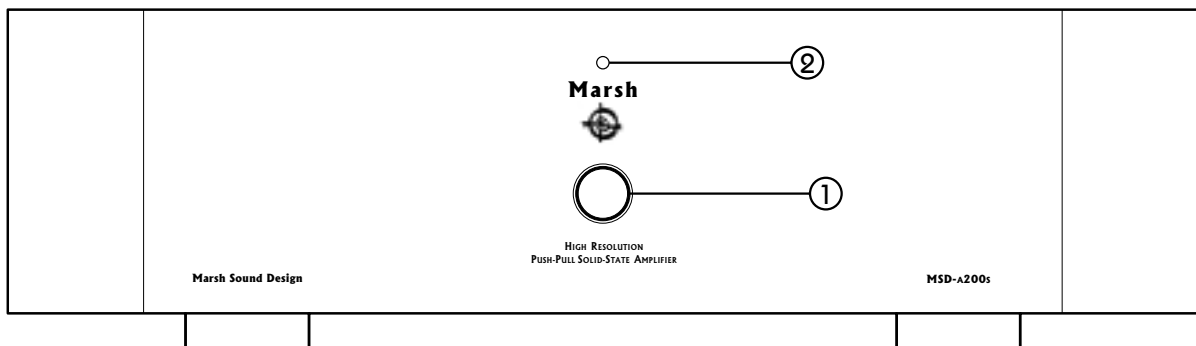

- 1. POWER** Pressing the **POWER** button once to turn the unit **ON**. Press the **POWER** button again to turn the unit **OFF**.
- 2. LED indicator** The LED on the front panel will appear **BLUE** when the unit is **ON**. The LED will not be lit when the unit is switched **OFF**.

In case of a malfunction, the unit will go into protect mode. The LED will be off. See more detail in the internal **Protections** section.

**REMARK:** *The MSD-A200S can be linked with other MARSH SOUND DESIGN remote control preamplifiers to utilize the remote on/off option of your preamplifier.*

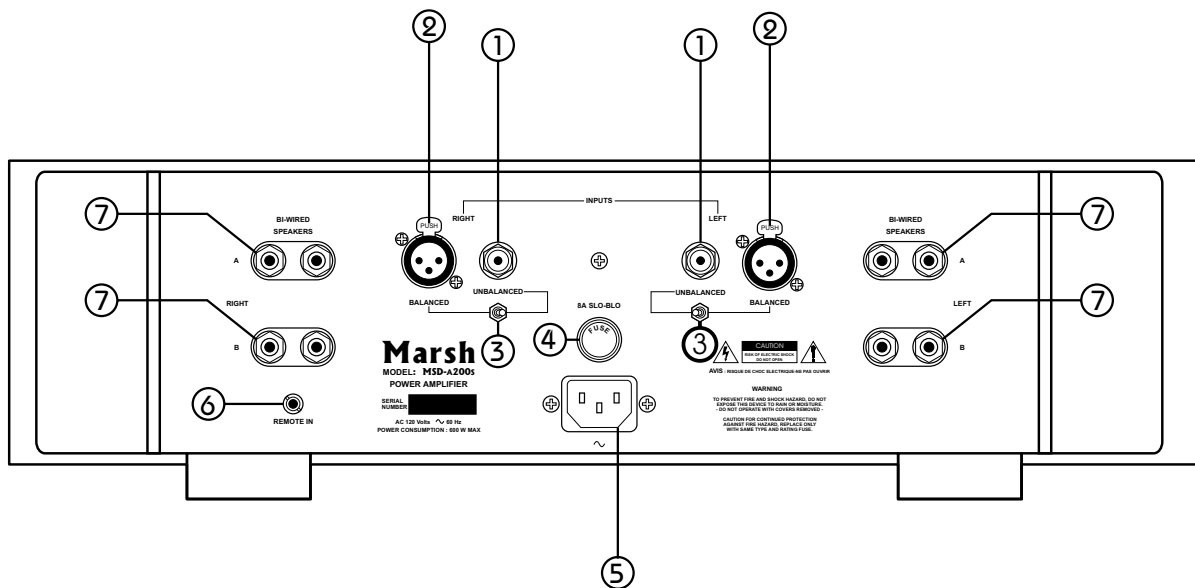

- |                            |   |
|----------------------------|---|
| 1. UNBALANCED INPUTS       | Receive signals from unbalanced preamplifier outputs.                                 |
| 2. BALANCED INPUTS         | Receive signals from balanced preamplifier outputs.                                   |
| 3. INPUT SELECTOR SWITCHES | Select according to the type of inputs being used.                                    |
| 4. MAIN FUSE               | If there is a problem with the fuse, replace with a fuse of the same type and rating. |
| 5. POWER                   | Connect the MSD-A200S to the outlet with the enclosed power cord.                     |

**IMPORTANT:** Operate the unit only from the power source of the appropriate voltage indicated on rear panel.

- |              |  |
|--------------|--|
| 6. REMOTE IN | This is a digitally controlled input designed to receive +12VDC from others MARSH SOUND DESIGN preamplifiers with remote Turn on capability or from other equipment e.g. power control center. With this function, the MSD-A200S can be powered ON/OFF synchronized with that equipment. |
| 7. SPEAKERS  | Output signals to speakers. The MSD-A200s has 2 output connections for each channel. It is designed to be used with a pair of bi-wire speakers.  |



## Internal Protections

- 1. OVER-CURRENT PROTECTION**

The MSD-A200S will go into protect mode and cut off the main power supply to protect the amplifier and speakers. This usually happens when the speaker terminals or wires are accidentally shorted together.
- 2. DC-FAULT PROTECTION**

The MSD-A200S will go into protect mode when it detects DC voltage at the speaker output. This is caused by a DC voltage leak from the pre-amplifier outputs or by an internal fault that gives a DC voltage leak at the speaker output.

When in the above mentioned protect mode, the unit will shut down to prevent damage to itself or the speakers. If this occurs, wait about 3 seconds for the unit to reset and turn itself on again.

If protect mode continues, turn the unit off and contact our service department.

- 3. OVERHEAT PROTECTION**

If the temperature of the output transistors exceed 76 degrees C, the MSD-A200S will shut itself down. It will not restart automatically. Wait 5 to 10 minutes to let the unit cool down, and then press the POWER button to turn it back on.

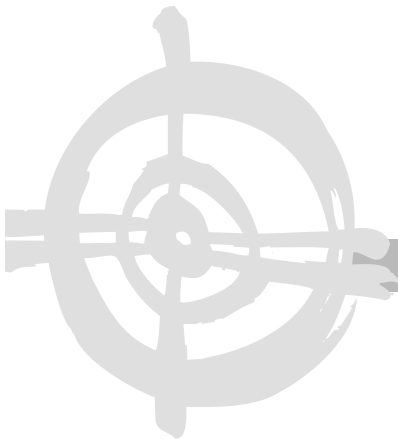

If the unit does not function properly, please check the list below and follow the instructions. If the problem still occurs, please contact our service department.

PROBLEM	SOLUTION
1. Unit does not turn on. The LED is not lit.	<p>Confirm that the power cord is plugged in properly.</p> <p>Check If the fuse is still good.</p>
2. No sound.	<p>Check the speaker cable connection.</p> <p>Check the interconnect cable connection.</p> <p>Check the setting of the input selector switches at the rear panel. They must be set according to the type of input (Balanced or Unbalanced) being used.</p>
3. No sound from one speaker.	<p>Check the speaker or interconnect cable connection.</p> <p>Check the BALANCE control on the preamplifier, make sure that it is in the middle position.</p>
4. Low bass sound.	<p>Check the speaker cables for correct phase connection.</p>



## Care & Maintenance

Use a soft, dry cloth to remove dust from the cabinet. For stubborn dirt, soak the cloth in a weak detergent solution. Be sure to wring the cloth well before wiping the unit. Use a dry cloth to wipe it dry. Do not use any volatile agents such as benzine or thinner. They may damage the surface of the cabinet.

**CAUTION:** DISCONNECT YOUR ENTIRE SYSTEM FROM THE AC MAINS BEFORE CLEANING. NEVER APPLY LIQUID CLEANSERS DIRECTLY TO THE UNIT. IT MAY RESULT IN DAMAGE TO THE ELECTRONIC COMPONENTS WITHIN THE UNIT.

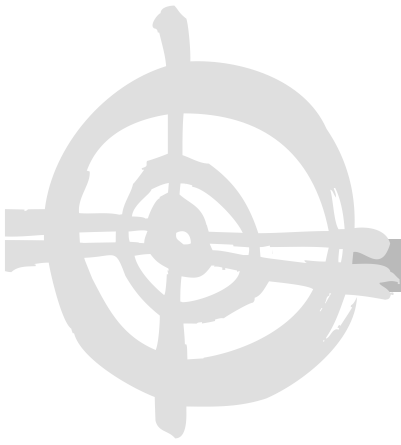

## Warranty information

- 1. A MARSH SOUND DESIGN warranty only applies to the original retail purchaser. The warranty certifies that the product is free from defects in material and workmanship and authorizes free service and/or parts exchange for a period of TWO years from the date of purchase. Service must only be done at an authorized MARSH SOUND DESIGN Service center.**
- 2. The warranty is subjected to the following conditions and limitations. The warranty is void if the product has been used in a manner other than that specified within the operating manual, if the product has been abused or misused, or if the product has been repaired by anyone other than an authorized MASH SOUND DESIGN Service center.**
- 3. The warranty does not apply to defects or failure caused by usage of unauthorized parts, improper maintenance, fire, flood, lightning or other natural causes.**
- 4. This warranty does not cover damage to the external parts, e.g. Front panel, knobs, casing, etc.**
- 5. A returned product must include a copy of the Warranty Certificate and the bill of sale and must be sent in the original packaging.**
- 6. The warranty does not extend to any incidental or consequential cost or damage to the purchaser caused by a malfunction of the product.**



## Specifications

<b>Maximum Power Output per Channel</b>	<b>120 W both channels driven continuously into 8 ohms load at 1 kHz</b> <b>190 W both channels driven continuously into 4 ohms load at 1 kHz</b>
<b>Frequency response, 20-20000 Hz</b>	<b>+0/- 0.2 dB at 1W to 100 W output into 8 Ohms loads</b> <b>-1 dB at 80 kHz</b>
<b>THD+ Noise at maximum output</b>	<b>&lt;0.02% from 20 Hz to 20 kHz into 8 Ohms loads</b> <b>(&lt;0.01% at 1 kHz.)</b>
<b>Input Sensitivity for 100 W at 8 Ohms load</b>	<b>1 Vrms for Unbalanced and Balanced Input mode</b>
<b>Input Impedance</b>	<b>56 kOhms Unbalanced, 4 kOhms Balanced input</b>
<b>Input Power</b>	<b>AC 110-120 V 60 Hz</b>
<b>Power consumption</b>	<b>600 W Max.</b>
<b>Size</b>	<b>19" W x 5 3/4" H x 13"D</b>
<b>Weight</b>	<b>Net 30 lbs (13.2 kgs), Shipping 34 lbs (15.2 kgs)</b>









**Marsh**

**MARSH SOUND DESIGN**

*Email: [sales@marshsounddesign.com](mailto:sales@marshsounddesign.com)*

*[www.marshsounddesign.com](http://www.marshsounddesign.com)*

*Tel: (415) 927-4672 Fax: (415) 924-6846*

*62 El Camino Drive, Corte Madera, CA 94925*