

OB36, OB52, OBS36, OBS52, OBSB162

dacor
The Life of the Kitchen.®

070607

**36", 52" Wide Outdoor Grills
16" Wide Side Burner**

1/3

**PLANNING
GUIDE**

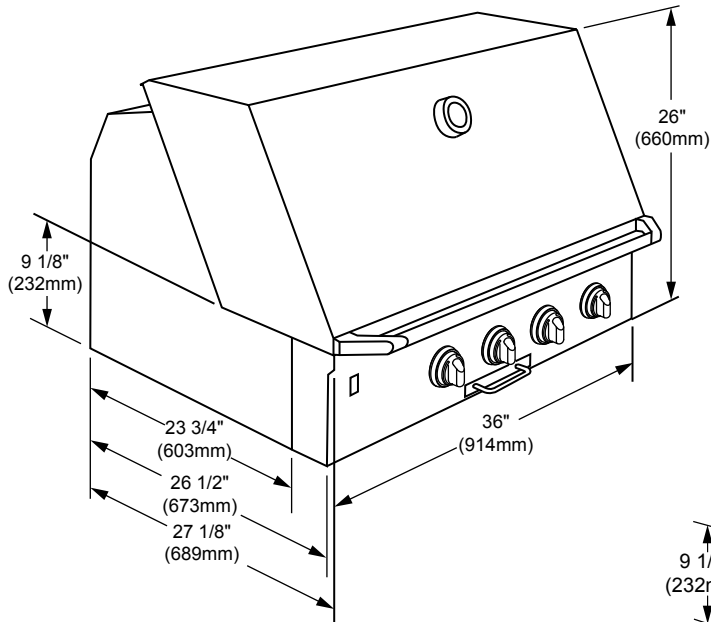

OB/OBS36 OVERALL DIMENSIONS

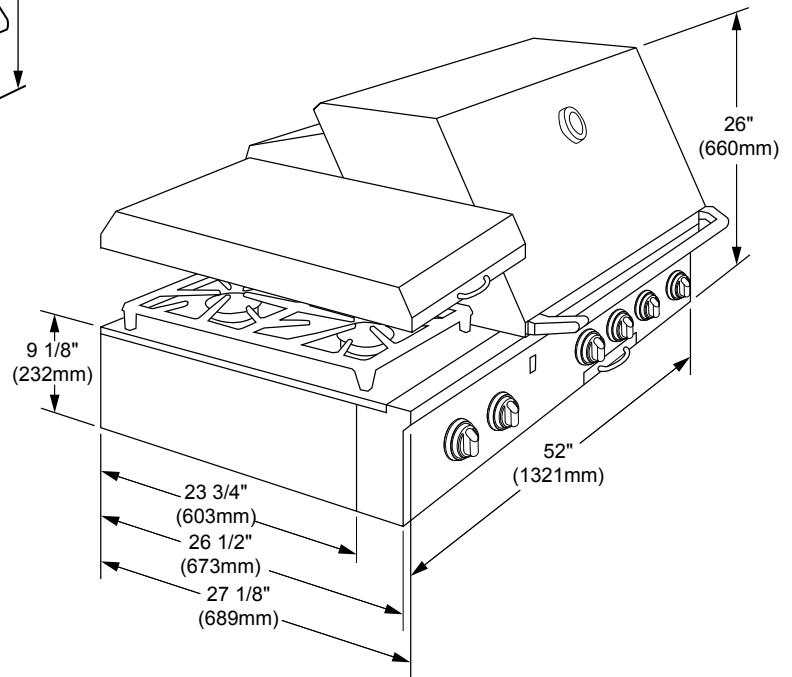

OB/OBS52 OVERALL DIMENSIONS

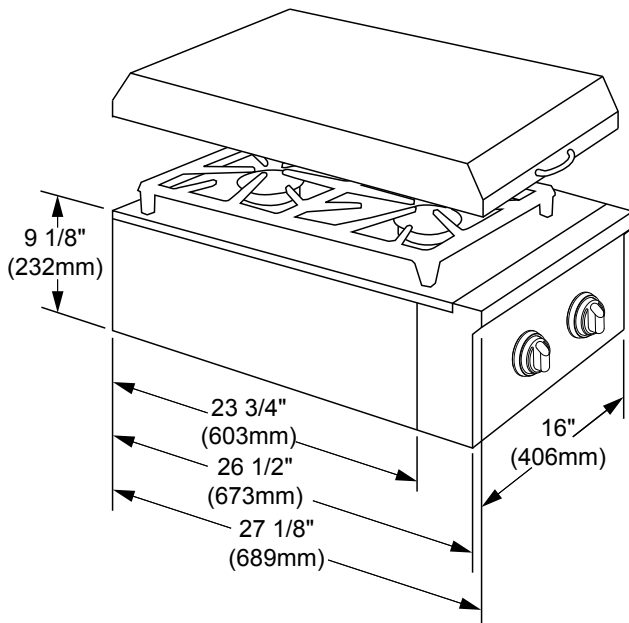

OBSB162 OVERALL DIMENSIONS

Model Type	Electrical Circuit Required	Total Connected Load	Gas Type	Manifold Pressure	Minimum Gas Supply Pressure
Natural Gas	120VAC, 60Hz, 15A	2.9 Amps (0.35kW)	Natural	4" Water Column	5" Water Column
LP Gas	120VAC, 60Hz, 15A	2.9 Amps (0.35kW)	Liquid Propane	11" Water Column	12" Water Column



NOTE:

Supply access for the rotisserie power or an alternate 120VAC duplex outlet location.

OB36, OB52, OBS36, OBS52, OBSB162



070607

36", 52" Wide Outdoor Grills 16" Wide Side Burner

2/3

PLANNING GUIDE

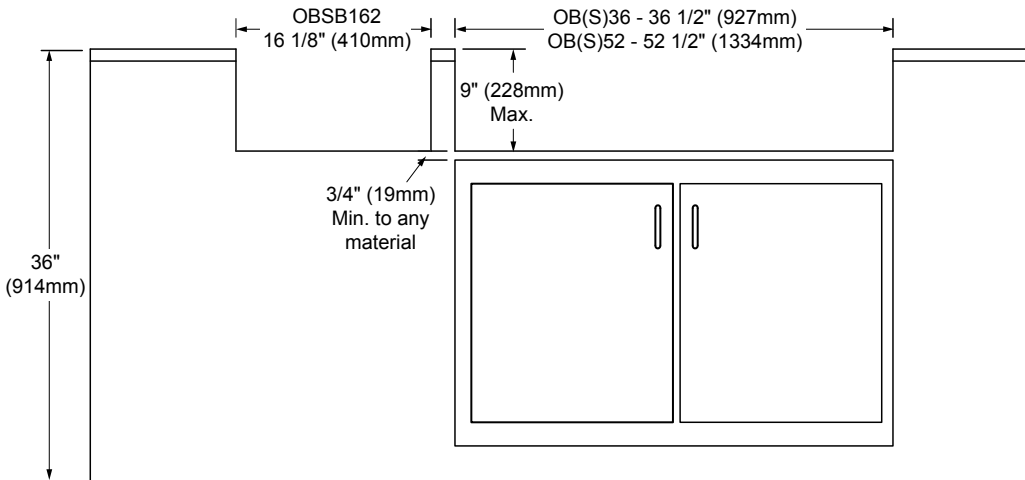

**OBSB162 & OB/OBS/36/52
CUTOUT DIMENSIONS, FRONT VIEW**
(OBAD 36" Accessory Door Shown)

Accessory Door Cutout Dimensions

	Dimension
Cutout Width	OBAD20: 16 3/4" (425mm) OBAD36: 33 1/8" (841mm)
Cutout Height	18 3/4" (476mm)
Cutout Depth	3" (76mm)

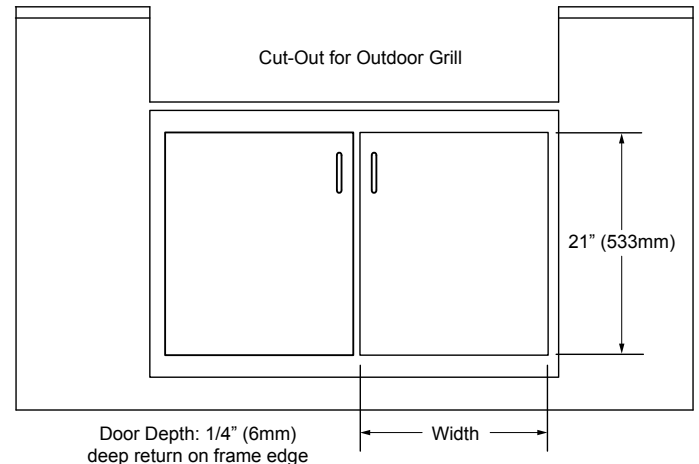

**OBXXX ACCESSORY DOOR
DIMENSIONS, FRONT VIEW**

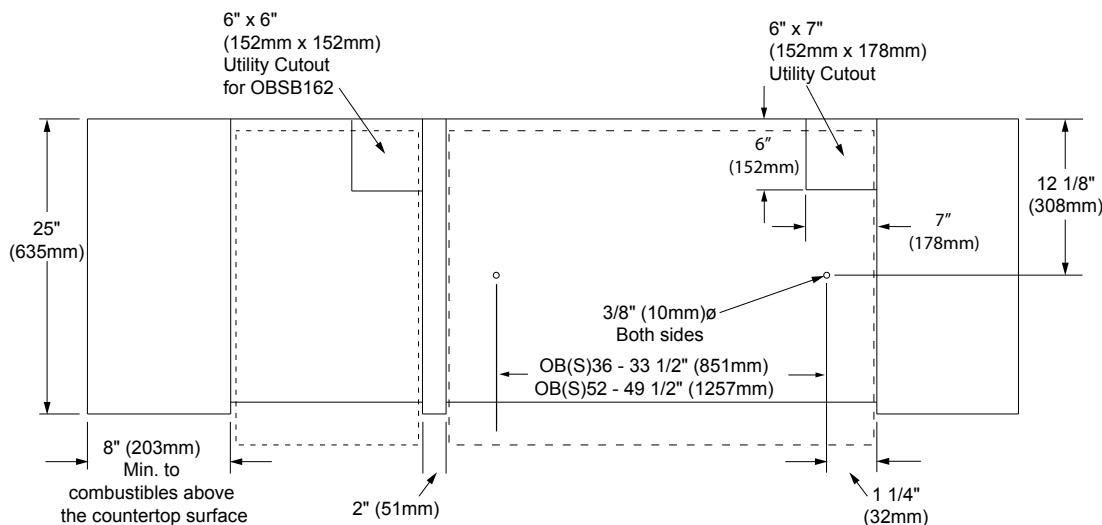

**OBSB162 & OB/OBS/36/52
CUTOUT DIMENSIONS, TOP VIEW**

OB36, OB52, OBS36, OBS52, OBSB162

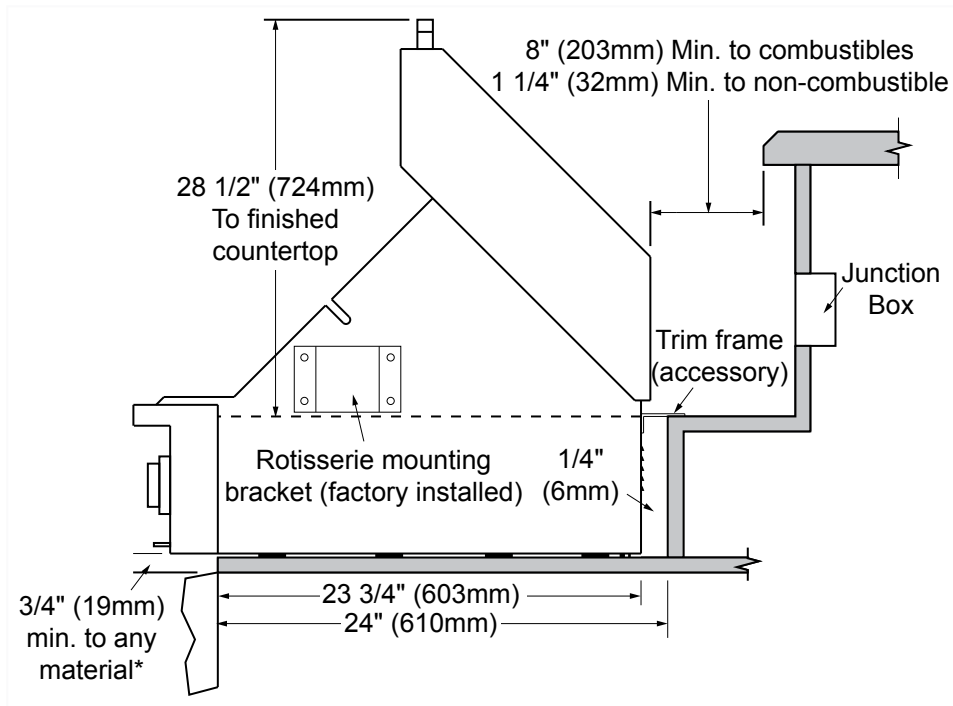

**OB36, OBS36, OB52 AND OBS52
CUTOUT DIMENSIONS, SIDE VIEW**

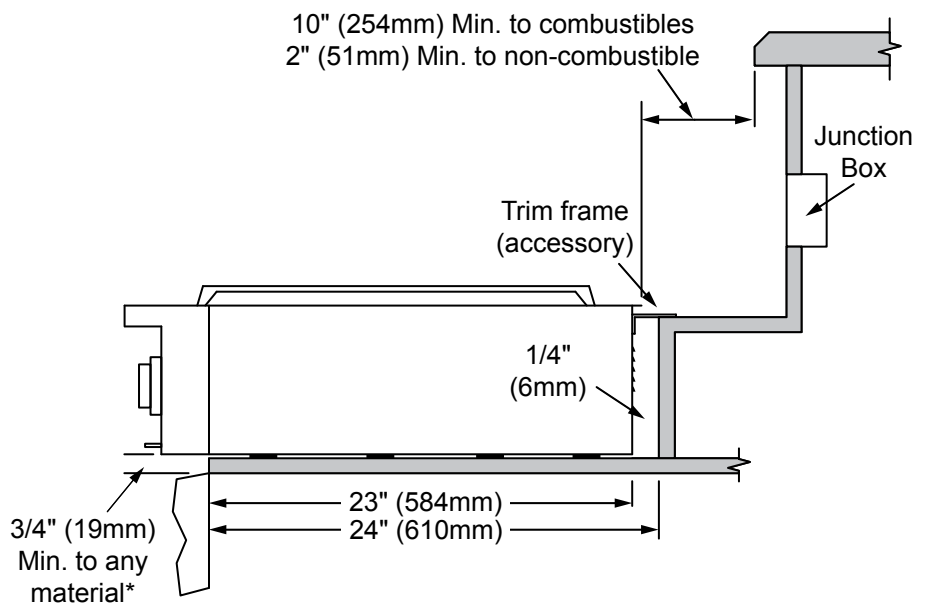

**OB162 CUTOUT DIMENSIONS
SIDE VIEW**