

Close

Specs/Dimensions



Product Information

Product Category	Warming Drawers
Product Series	-
Product Name	30" Warming Drawer
Model Number	HWD30xUC
Color	Stainless Steel
Also available in	White, Black

Product Detail

Oven Capacity - Cubic Feet, Upper or Single Oven	1.9
--	-----

General Information

Cubic Feet	2
Approximate Shipping Weight (lbs.)	72

Technical Information

Warming Drawer Wattage	450
AMPS	15

Dimensions

Overall Dimensions - A	11 1/4"
Overall Dimensions - B	29 1/4"
Overall Dimensions - C*	22 1/4"
Overall Dimensions - D	20 1/2"
Overall Dimensions - E**	10"
Overall Dimensions - F**	25 3/4"
Overall Dimensions - G**	22 1/4"

Dimensions

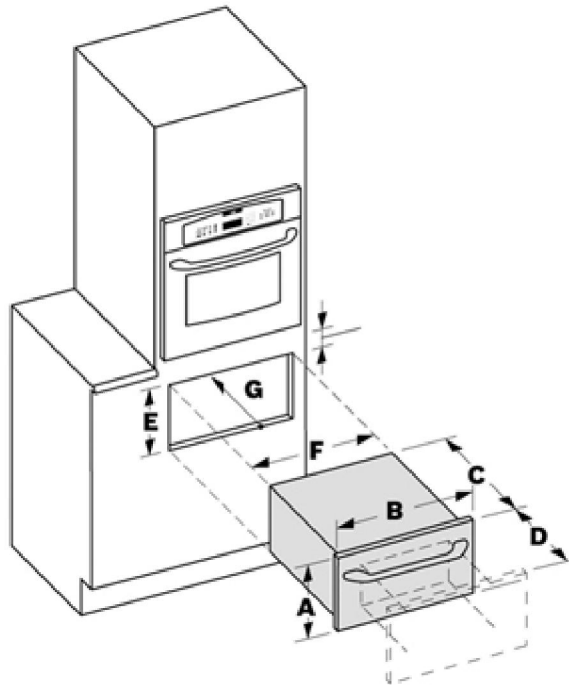

Special Notes

*Measured from cabinet face. Add 3 1/4" for distance from drawer handle to cabinet face.

**Dimensions are for planning only. Please refer to installation instructions prior to making cutout. For details, see installation manual. Specifications subject to change without notice.

2-1/2" minimum space is recommended between the bottom of the oven and the top of the Warming Drawer, if the Warming Drawer is installed below a single oven.

[Click Here to View Features](#)

[E-mail](#)

[Print](#)

[Close](#)