

# K210A SERIES RANGE HOOD

Provides high ventilation and durable construction to meet the needs of professional-style home cooking appliances

A complete installation requires several optional components.

**FEATURES**

*HOOD:*

- Widths – 30" to 48" in 6" increments
- Finishes – Stainless Steel and appliance colors in White, and Black
- Aluminum / stainless steel grease filters are dishwasher safe
- Halogen lights (2 x 50W PAR20 for 30" and 36" hood; 3 x for 42" and 48" hood) (purchase separately)
- Infinite speed blower control with speed memory
- Exclusive, Broan Heat Sentry™ turns blower ON to HIGH speed when excess heat is detected
- Baffle filters available

*BACKSPLASH:*

RP Series (Optional)

- Widths – 30" to 48" in 6" increments
- Stainless Steel construction – protects back wall and wipes clean easily
- Two, dual-position condiment storage shelves

**SPECIFICATION**

Volts: 120

Hz: 60

Amps (without blower): 1.3 (for 42" and 48" hood)  
0.8 (for 30" and 36" hood)

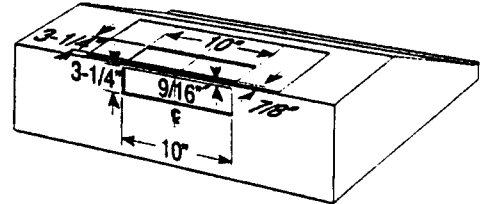

K210A series hood

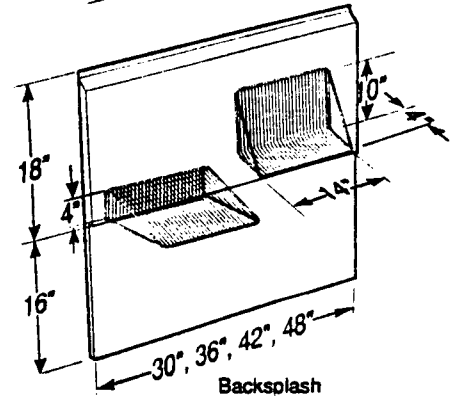
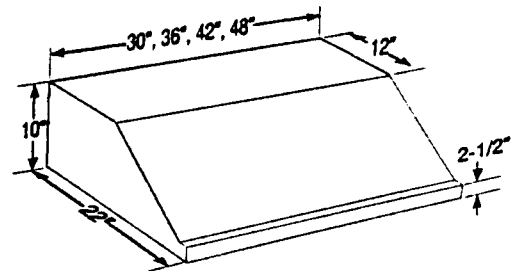

Backsplash



REFERENCE	QTY.	REMARKS	Project	
			Location	
			Architect	
			Engineer	
			Contractor	
			Submitted By	Date

# K210A SERIES RANGE HOOD SYSTEM

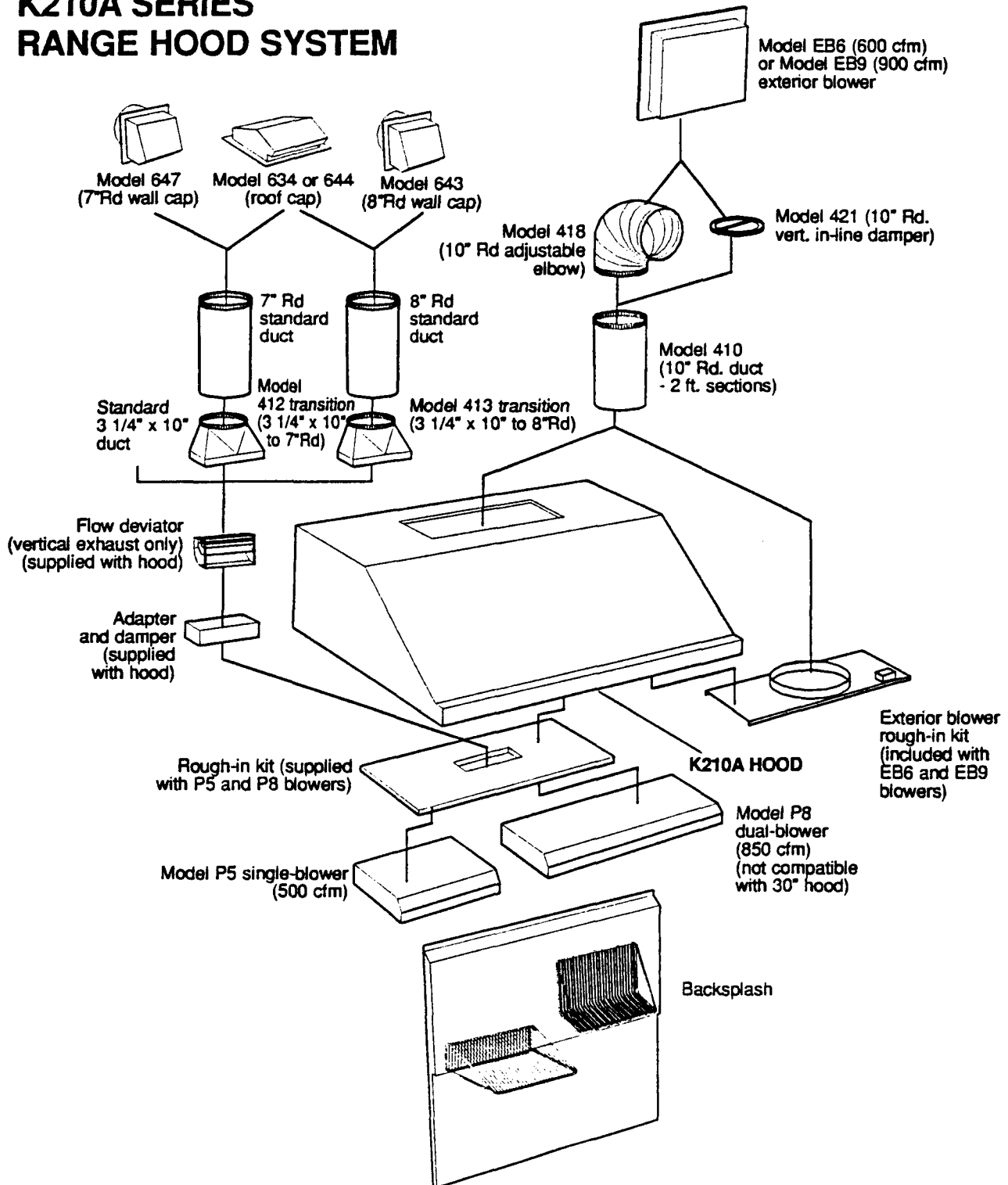

**best**  
BY BROAN

BEST BY BROAN P.O. Box 140, Hartford, WI 53027

## BLOWER / ROUGH-IN KITS AND DUCTING ACCESSORIES

For use with Best by Broan K210A Series Range Hoods

Provides high ventilation and durable construction to meet the needs of professional-style home cooking appliances

### FEATURES

#### BLOWERS:

##### Model P5

- 500 cfm, 120 VAC, 1.8 Amps
- Interior-mounted, single-wheel design – attaches to rough-in plate independent of hood
- Includes Rough-in Kit
- Uses 3-1/4" x 10" duct, 7" or 8" round duct

##### Model P8 (not available for 30" hood)

- 850 cfm, 120 VAC, 3.4 Amps
- Interior-mounted, dual-wheel design – attaches to rough-in plate independent of hood
- Includes Rough-in Kit
- Uses 3-1/4" x 10" duct or 8" round duct

##### Model EB6/EB9

- 600/900 cfm, 120 VAC, 2.3/5.8 Amps
- Exterior-mounted, all aluminum construction
- Includes Rough-in Kit
- Use with 10" round duct

### SPECIFICATION

Model	Volts	HZ	AMPS	CFM
P5	120	60	1.8	500
P8	120	60	3.4	850
EB6	120	60	2.3	600
EB9	120	60	5.8	900

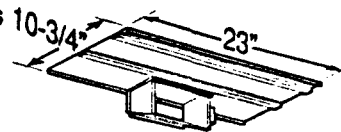

Model P5  
blower / rough-in kit

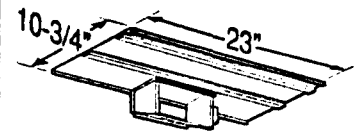
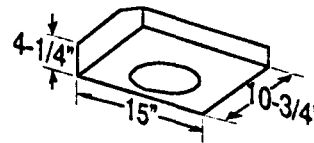

Model P8  
blower / rough-in kit

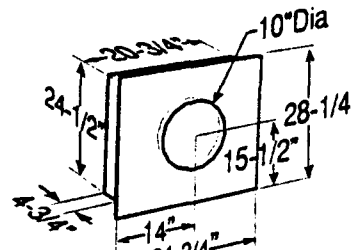
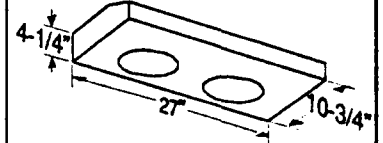

Models EB6 & EB9  
exterior blowers

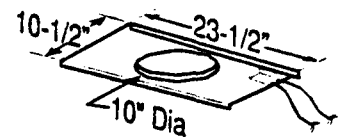

Exterior blower rough-in kit

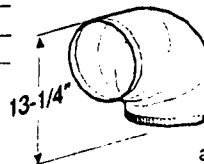

Model 418  
10" Rd.  
adjustable elbow

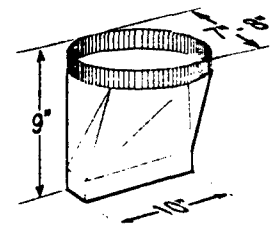

Model 412/413  
3-1/4" x 10" to 7"8" Rd. transition

REFERENCE	QTY.	REMARKS	Project
			Location
			Architect
			Engineer
			Contractor
			Submitted By
			Date

# K210A SERIES PERFORMANCE RATINGS

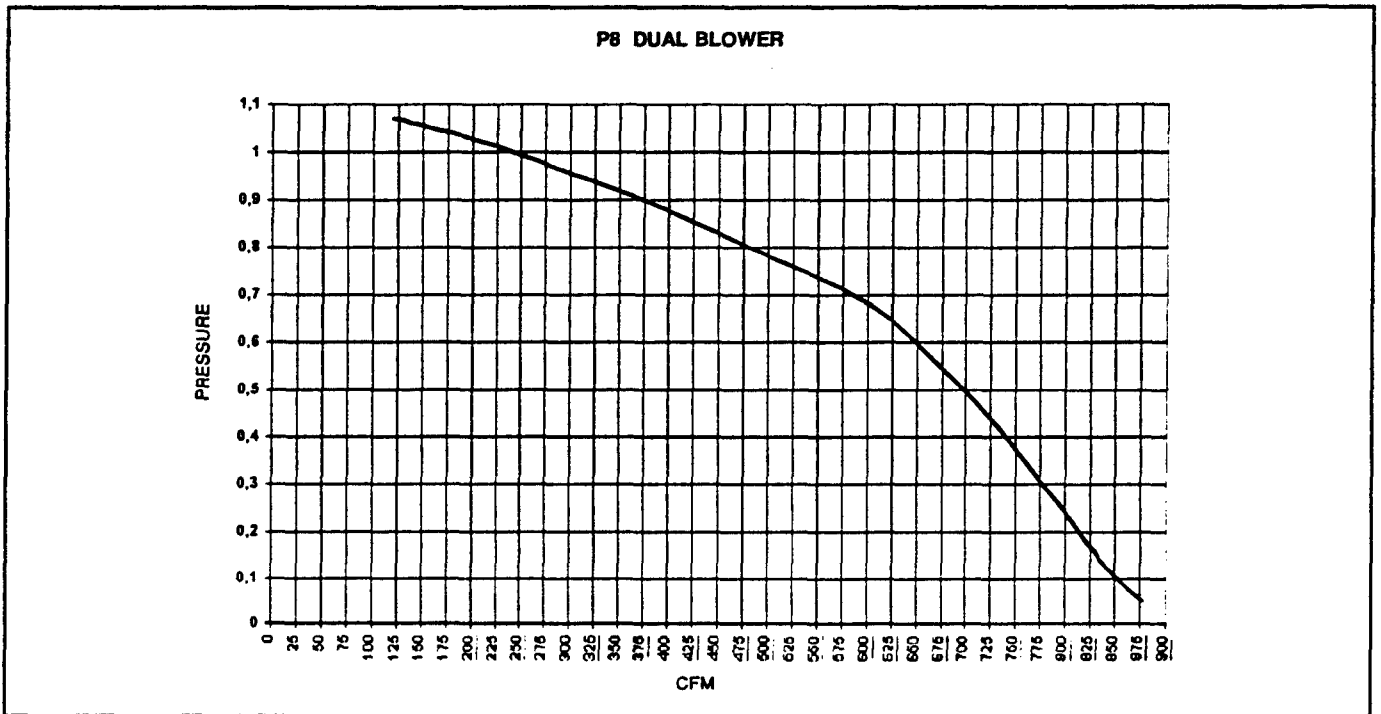
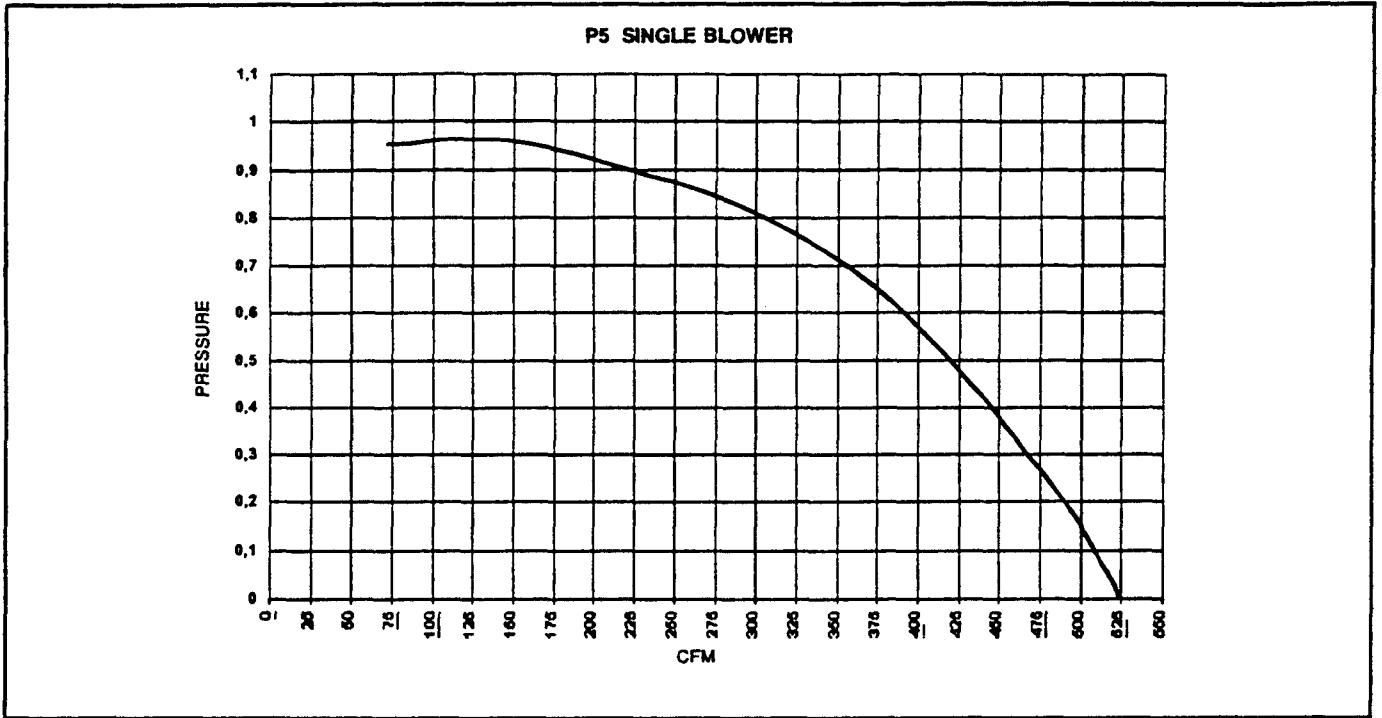

BEST BY BROAN P.O. Box 140 Hartford, WI 53027