

PIK SERIES INSERT

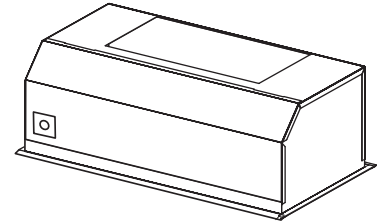

Especially designed to be installed in custom hood for use over residential commercial-style cooking surfaces.

FEATURES

- Cabinet mount – custom application
- Widths: 33", 45"
- Halogen lighting (33" – 2 x 50 watt; 45" – 3 x 50 watt PAR20) lamps not included
- Slide controls: Lighting, on-off, infinite speed
- Easily accessible, dishwasher-safe stainless steel baffle filters
- Heat Sentry™ turns blower ON to HIGH speed when excess heat is detected

OPTIONS

- Custom hood liners (L33 or L45 Series):
Widths - 36", 42", 48", 54" and 60"
Adjustable depth - see liner spec. sheet for details
Stainless Steel construction - protects custom hood base and wipes clean easily
- Ambient light panel (ALP Series) for L Series custom hood liners (Halogen lighting: 36" and 42" – 2 x 50 watt; 48", 54" and 60" – 3 x 50 watt GU10) Lamps included
- Backsplash (RMP Series):
Widths - 36", 42", 48", 60"
Stainless Steel construction - protects back wall and wipes clean easily
- WCPI Remote control: With Stainless Steel faceplate, to fit any décor.

INSERT SPECIFICATIONS

120 VAC, 60 Hz
Amps (without blower) 0.8 (PIK33), 1.3 (PIK45)

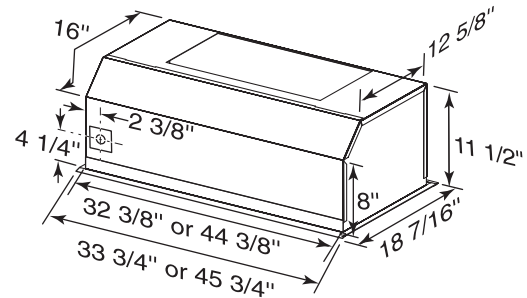

Mount insert so bottom of custom hood is 24" to 30" above cooking surface.

Custom Hood Liner
L33 or L45 Series

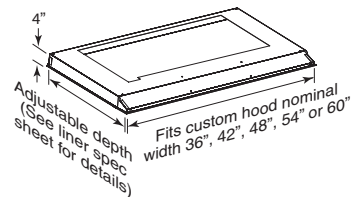

Ambient Light Panel
ALP Series

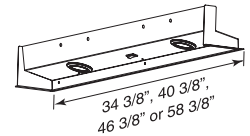

Backsplash
RMP Series

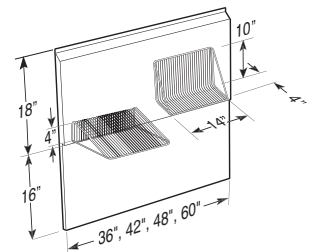

WCPI Remote Control

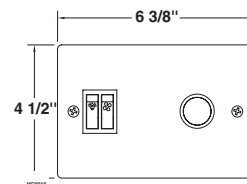

BEST BY BROAN P.O. BOX 140 HARTFORD, WISCONSIN 53027

REFERENCE	QTY.	REMARKS	Project	
			Location	
			Architect	
			Engineer	
			Contractor	
			Submitted by	Date

PIK MOUNTING

SIZE OF THE CUT-OUT

NOTE: If optional L series liner is used, refer to installation instructions for size and location of the cut-out.

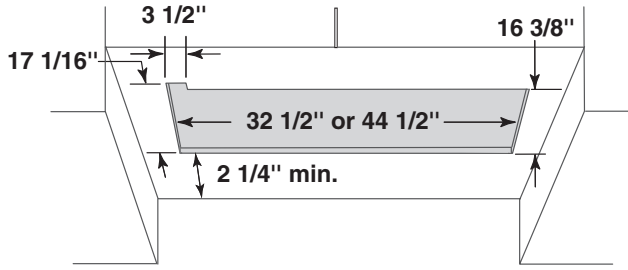

Suggested Custom Hood Internal Framework

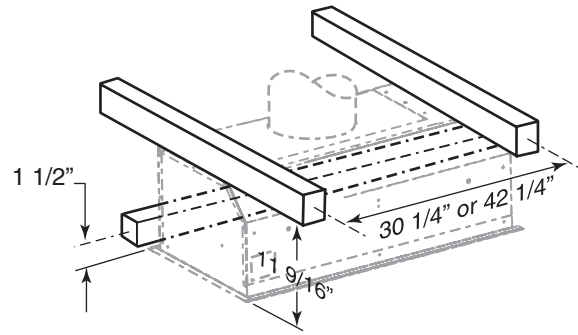

NOTE: The 3 1/2\" notch must be cut only if the WCPI optional wall control will be installed.

PIK33 AND PIK45

INSERT SYSTEM

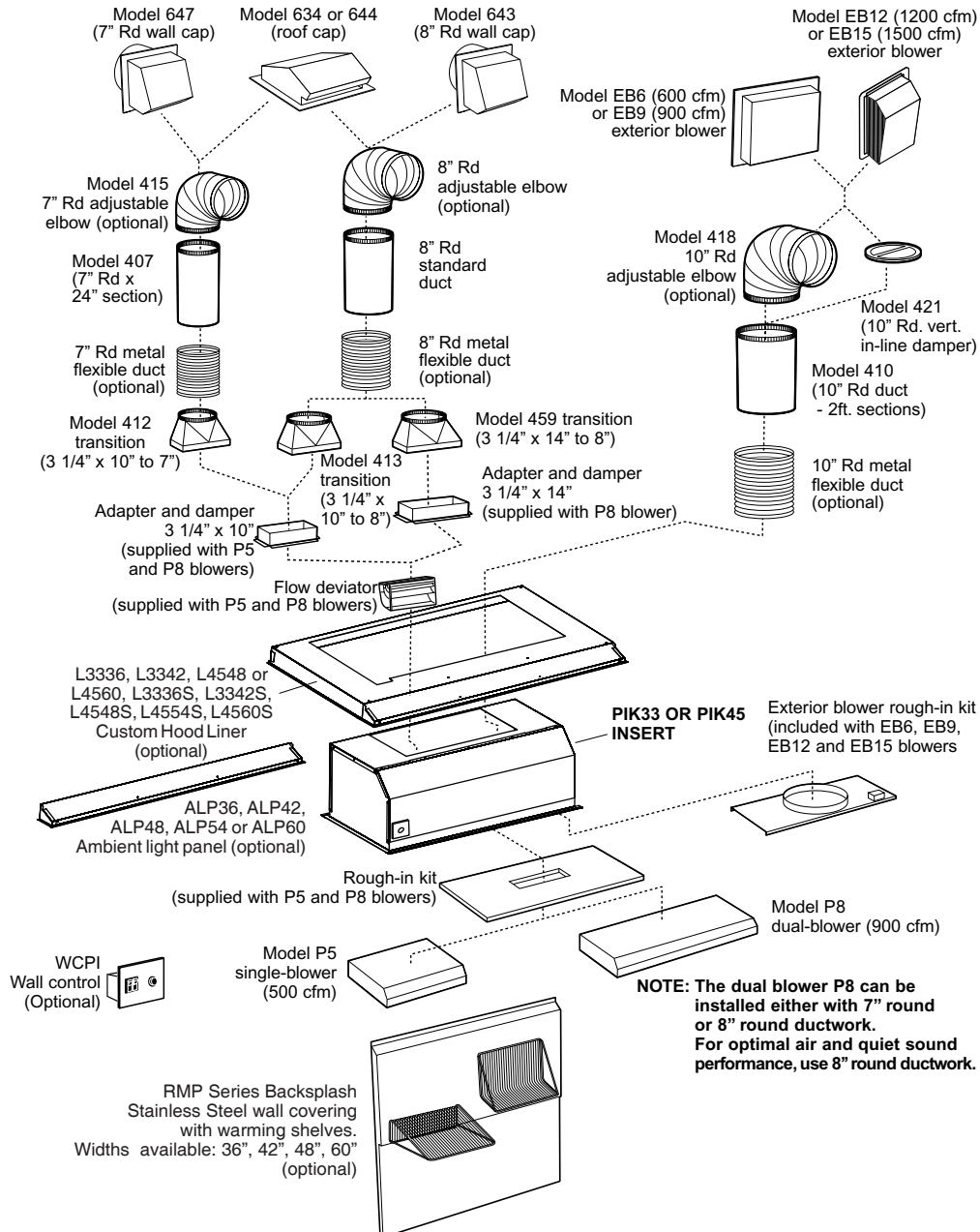

PIK SERIES INSERTS BLOWER DUCTING POSITIONS

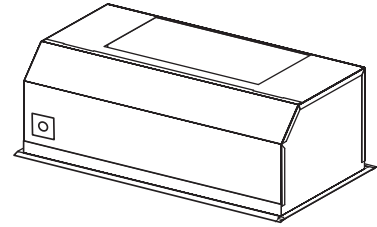

MODEL PIK33 WITH P8 BLOWER (Vertical Outlet)

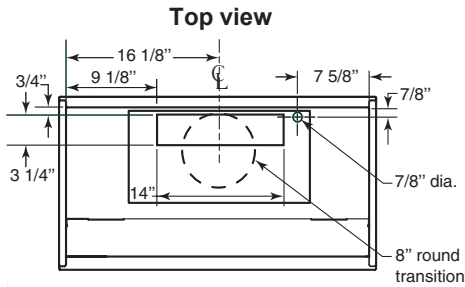

MODEL PIK45 WITH P8 BLOWER (Vertical Outlet)

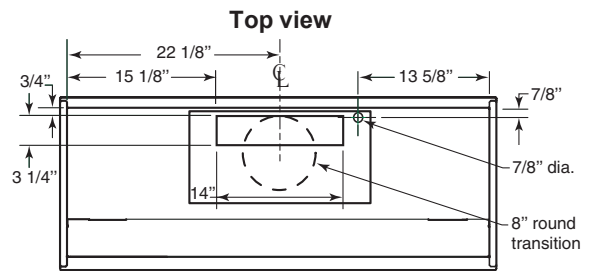

MODEL PIK33 WITH P5 BLOWER (Vertical Outlet)

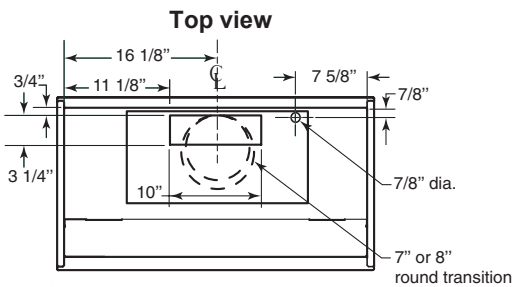

MODEL PIK45 WITH P5 BLOWER (Vertical Outlet)

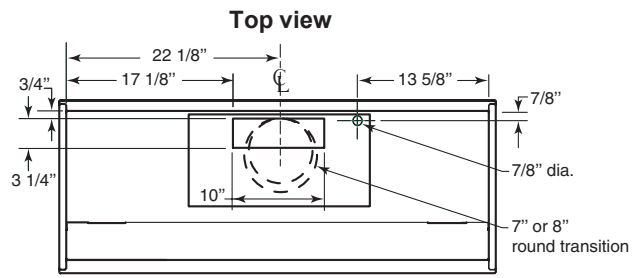

MODEL PIK33 WITH EB6, EB9, EB12 OR EB15 BLOWER (Vertical Outlet)

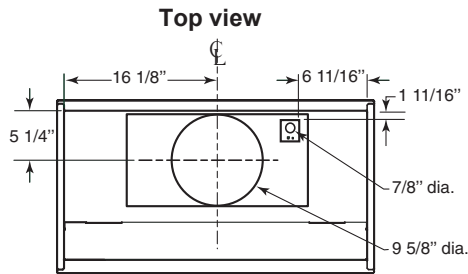

MODEL PIK45 WITH EB6, EB9, EB12 OR EB15 BLOWER (Vertical Outlet)

