

# VentA Hood® UNDER CABINET RANGE HOOD SPECIFICATIONS

SL6/SLH6 "H" in part number indicates halogen lighting. WL-1 warming lights are available on selected models.

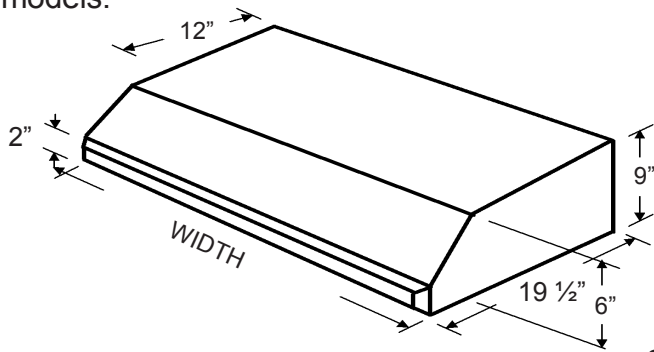

**SL6/SLH6**

**SL6/SLH6 SIDE VIEW**

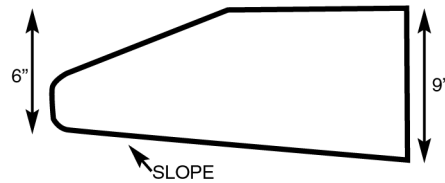

## Connection Diagrams (30" - 48" Widths)

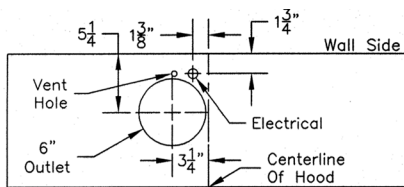

**300 CFM B100 Single Blower  
(Top View)**

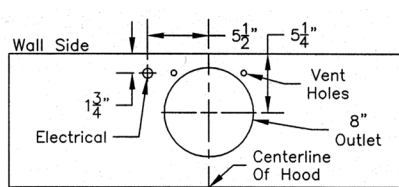

**600 CFM B200 Dual Blower  
(Top View)**

## Recommended Mounting Height\*

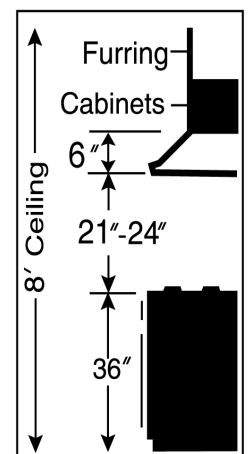

\*Exceeding recommended mounting height may compromise performance.

## Connection Diagram (42" - Wider)

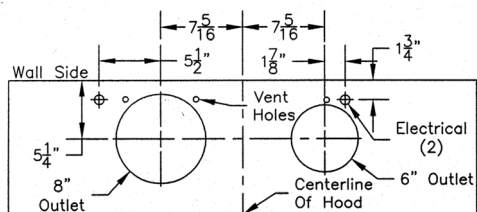

**900 CFM B200 Dual & B100 Single Blower  
(Top View)**

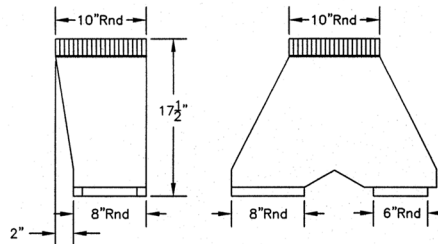

VP562 Transition (Optional) For B300  
(B200 Dual Blower & B100 Single Blower)

## Connection Diagram (48" - Wider)

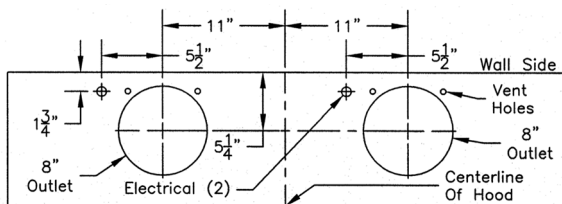

**1200 CFM Double B200 Dual Blowers  
(Top View)**

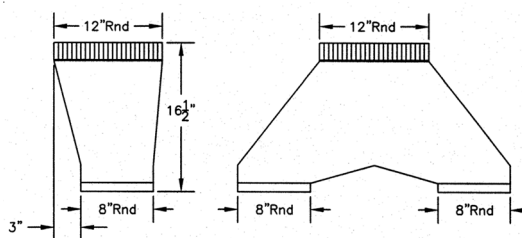

VP563 Transition (Optional) For B400  
(B200 Dual Blower & B200 Dual Blower)

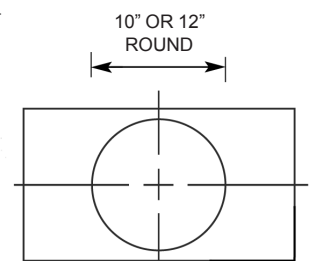

VP562/VP563 transition centers outlet over top of hood

## Electrical/Mechanical Specifications For Blower Units

Model	Type	Volts	Amps	Hz	RPM	CFM SP@0.0"	Equivalent CFM	CFM SP@0.1"	CFM SP@0.2"	CFM SP@0.3"	Minimum Round Duct Size	Square Inches
B100 Single	Shaded Pole	115	1.7 ●	60	1550	300	450	286	270	240	6" (or equivalent)	28
B200 Dual	Shaded Pole (2)	115	3.4 ●	60	1550	600	900	572	540	480	8" (or equivalent)	50

●Note: Add 2.5 amps for each warming light and .5 amp for each halogen bulb. Equivalent CFM refers to the fact that the Magic Lung blower uses centrifugal filtration units, whereas others use conventional filters. Apply this guideline when comparing blower units made by other manufacturers. Hood is available with fluorescent light (1 for each single or dual blower) or with halogen lights- 30" to 41" 2 lights, 42" to 53" 3 lights, 54" to 66" 4 lights, over 66" 1 light for each 16" hood width.

