

VentA Hood® UNDER CABINET RANGE HOOD SPECIFICATIONS

SL6/SLH6 "H" in part number indicates halogen lighting. WL-1 warming lights are available on selected models.

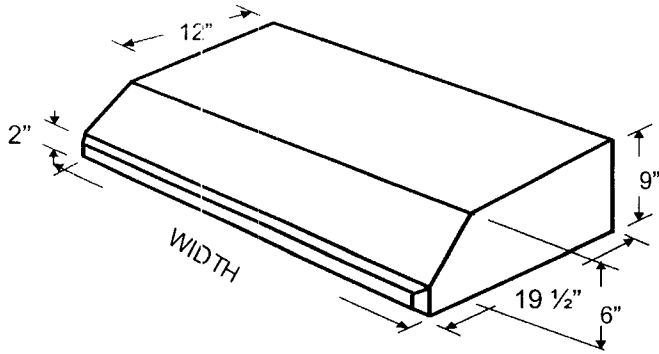

SL6/SLH6 SIDE VIEW

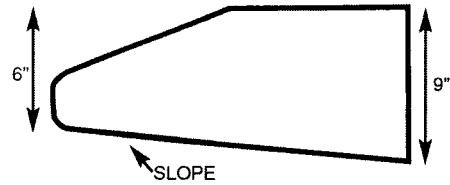

SL6/SLH6

Blower Outlet Diagrams (30" - 48" Widths)

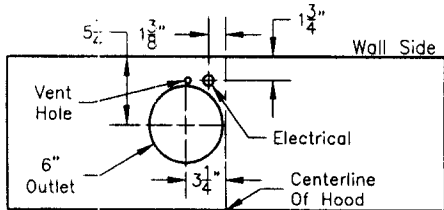

Top View--B100 Single Blower

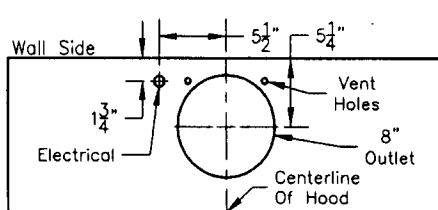

Top View--B200 Dual Blower

Mounting Height

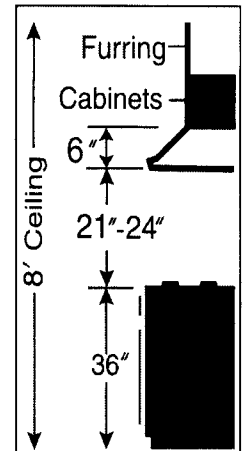

Blower Outlet Diagrams (42" - Wider)

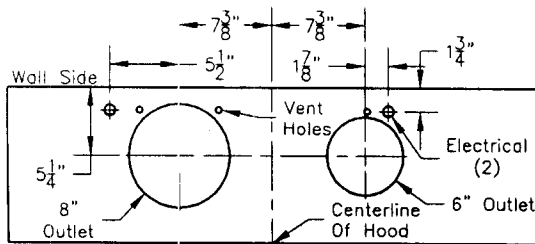

B200 Dual Blower B100 Single Blower
Top View

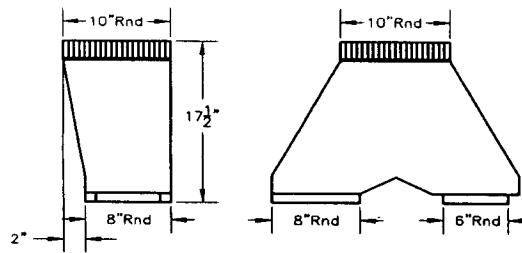

VP562 Transition (Optional) For B300
(B200 Dual Blower & B100 Single Blower)

Blower Outlet Diagrams (48" - Wider)

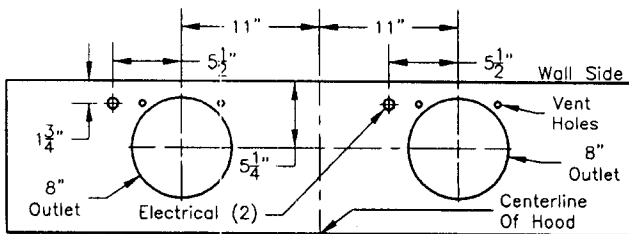

B200 Dual Blower B200 Dual Blower
Top View

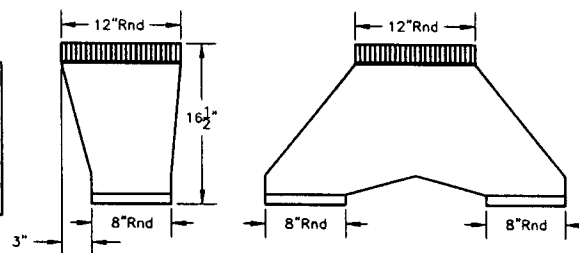

VP563 Transition (Optional) For B400
(B200 Dual Blower & B200 Dual Blower)

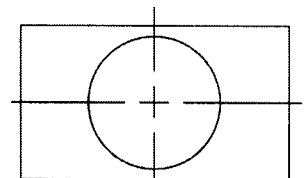

VP562/VP563
transitions
center outlet
over top of hood

Electrical/Mechanical Specifications For Blower Units

Model	Motor	Type	Volts	Amps	HZ	RPM	CFM SP@0.0"	Equivalent CFM	CFM SP@0.1"	CFM SP@0.2"	CFM SP@0.3"	Minimum Round Duct Size	Square Inches
B100 Single	1/25	Shaded Pole	115	1.7•	60	1550	300	450	286	270	240	6" (or equivalent)	28
B200 Dual	(2) 1/25	(2) Shaded Pole	115	3.4•	60	1550	600	900	572	540	480	8" (or equivalent)	50

● Note: Add 2.5 amps for each warming light and .5 amp for each halogen bulb. Equivalent CFM refers to the fact that the Magic Lung blower uses centrifugal filtration units, whereas others use conventional filters. Apply this guideline when comparing blower units made by other manufacturers. Hood is available with fluorescent light (1 for each single or dual blower) or with halogen lights- 24" to 41" 2 lights, 42" to 53" 3 lights, 54" to 66" 4 lights, over 66" 1 light for each 16" hood width.

SPECIFICATIONS SUBJECT TO CHANGE WITHOUT NOTICE Rev. 05/05