

POP & LOCK[®]

Installation Instructions

Tailgate Lock PL5100

Toyota Tacoma 1995 and up

Contents:

Lock Assembly
Instructions
Warranty Card

Tools Required:

Phillips Head Screw Driver

Tech Support:

Call 1-800-342-5911

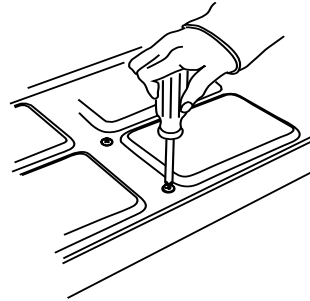

1. Unscrew the 8 access panel screws and remove panel

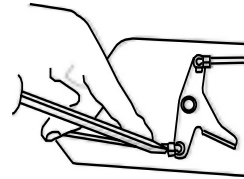

2. Pry plastic rod retainers off using a pry bar and remove rods

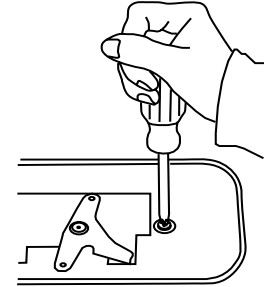

3. Unscrew the two handle mounting screws and remove handle

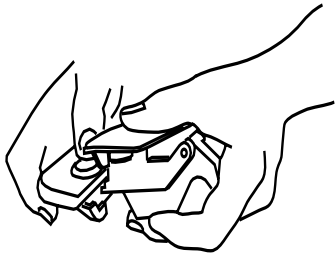

4. Join the handle and the POP&LOCK. They go together like a tongue and groove.

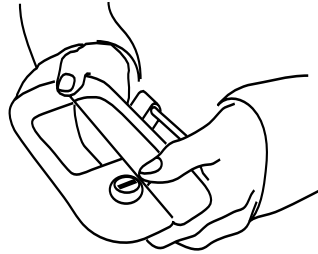

5. Push the handle firmly down onto the POP&LOCK until they click together to form a tight assembly.

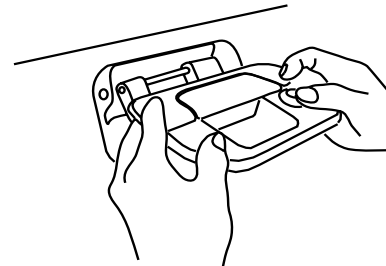

6. Insert the handle and POP&Lock assembly into the tailgate.

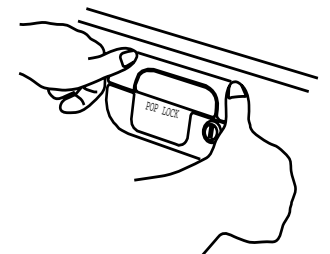

7. Push the assembly down to align it with the mounting holes. Reassemble all components in the reverse order.