

DURACELL®

Lithium/Manganese Dioxide

2/3A

Li/MnO₂

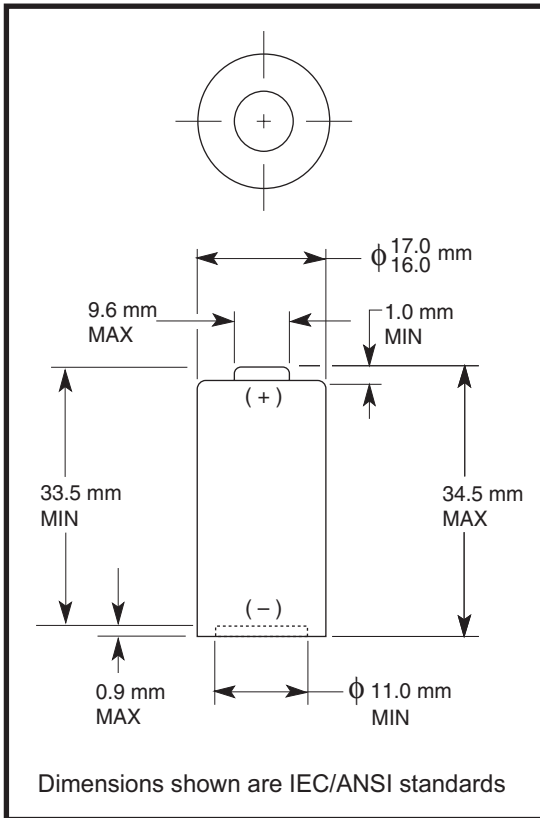

Nominal Voltage:	3.0 V
Typical Voltage:	3.2-3.3 V
Nominal Internal Impedance:	0.25 ohm @ 1kHz
Average Weight:	17.0 gm
Volume:	7.18 cm ³
Terminals:	Flat, Recessed Negative Terminal, Nickel Plated Steel
Operating Temperature Range:	-20°C to 75°C (-4°F to 167°F)
ANSI:	5018LC
IEC:	CR17345

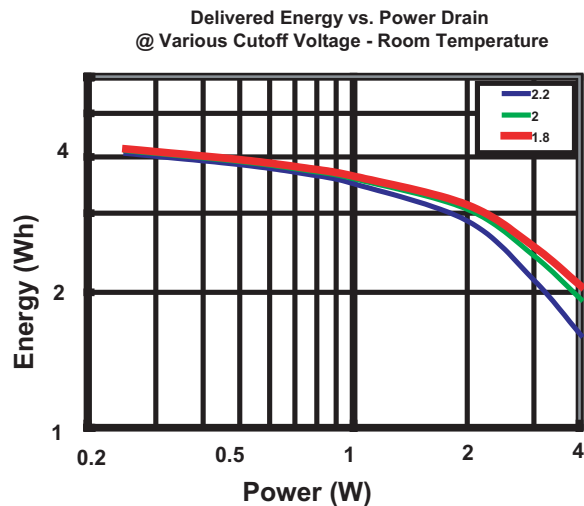

Duracell 2/3A Typical Performance

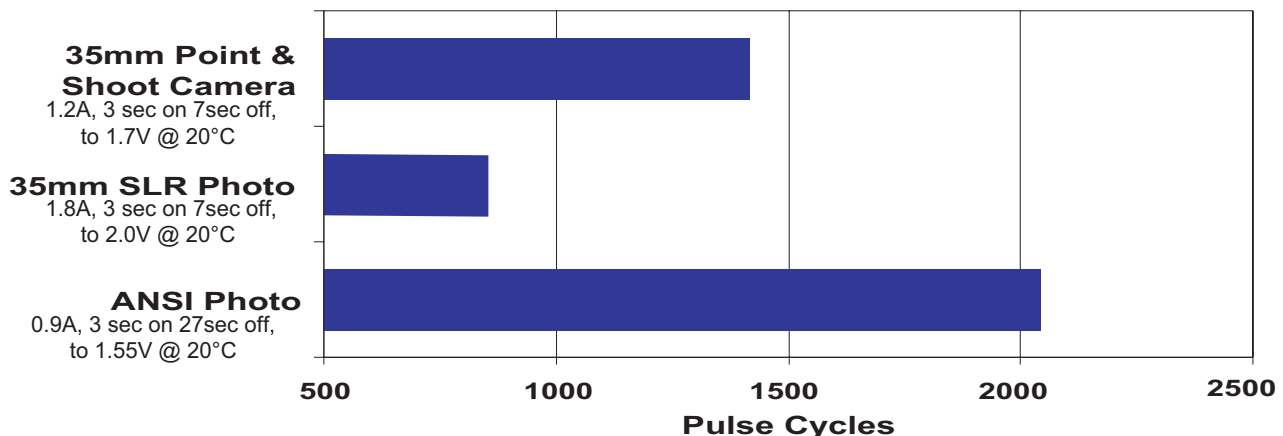

* Delivered capacity is dependent on the applied load, operating temperature and cut-off voltage. Please refer to the charts and discharge data shown for examples of the energy / service life that the battery will provide for various load conditions.

DURACELL®

Lithium/Manganese Dioxide

2/3A

Li/MnO₂

1.8 Amp 3 sec on/ 7 sec off
@ Various Temperatures

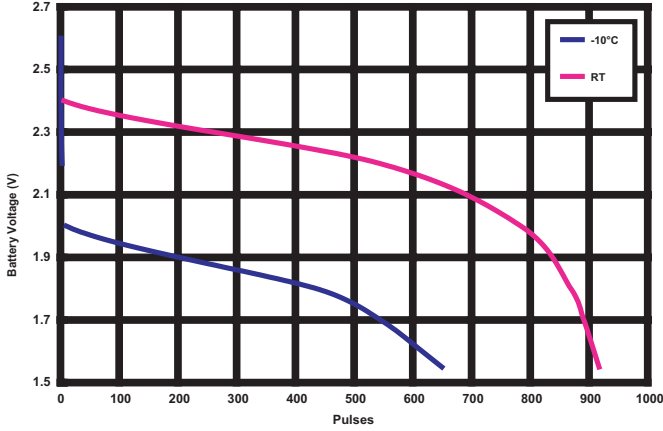

1.2 Amp, 3 sec on/ 7 sec off
@ Various Temperatures

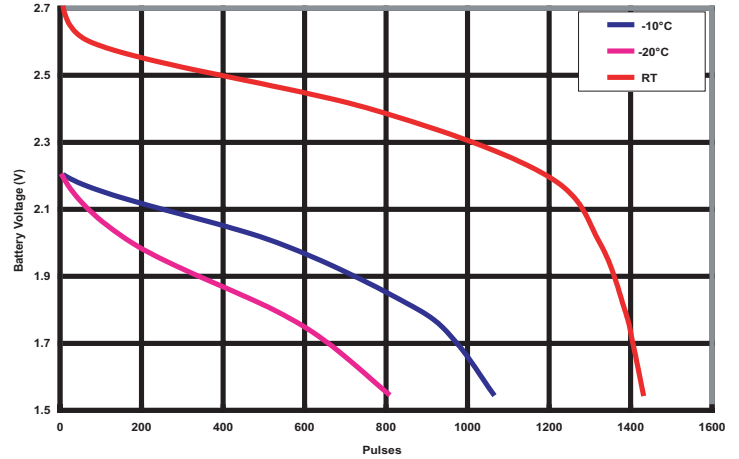

Continuous Discharge
RT to 1.55 Volts

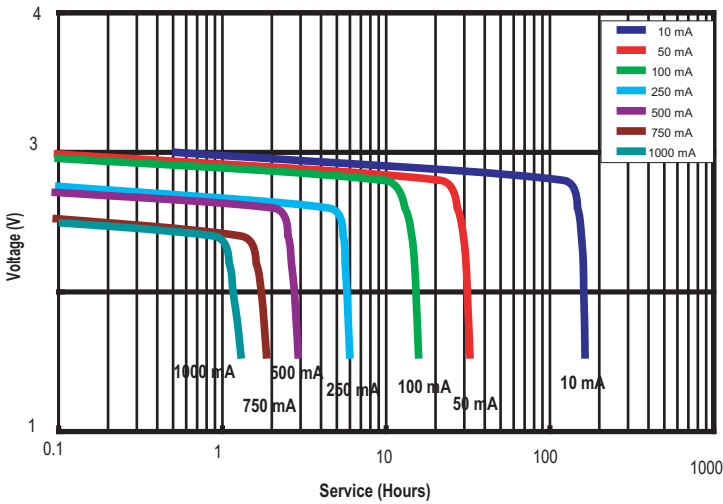

0.9 Amp, 3 sec on/27 sec off
@ Various Temperatures

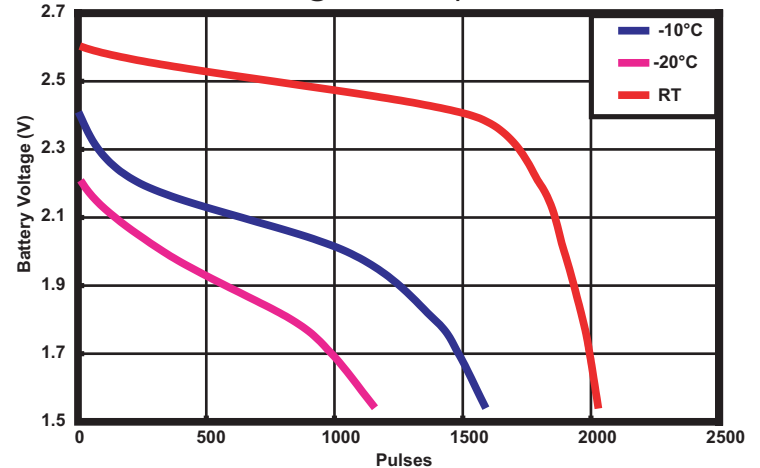

DURACELL®
BATTERIES

Berkshire Corporate Park
Bethel, CT 06801 U.S.A.
Telephone: Toll-free 1-800-544-5454
Internet: www.duracell.com

* Delivered capacity is dependent on the applied load, operating temperature and cut-off voltage. Please refer to the charts and discharge data shown for examples of the energy / service life that the battery will provide for various load conditions.