

Use this form to build your Humanscale M7 Monitor Arm. To place your order, call 800-531-3746 ext.1



### Build Your M7 Flat Panel Monitor Arm



#### 1 Arm Style

#### Top Mount

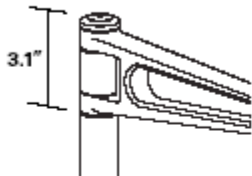

T1

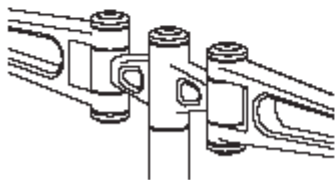

T2

#### Bracket Mount

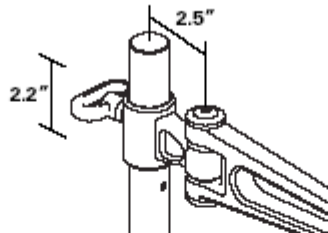

B1

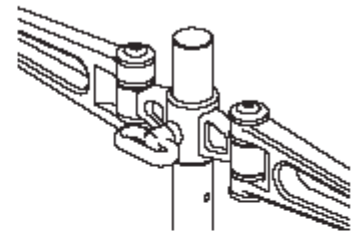

B2

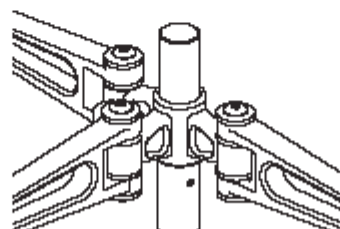

B3

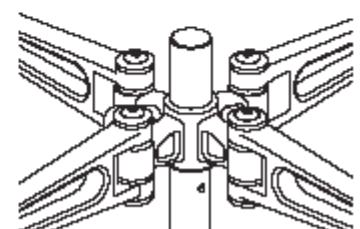

B4

To place an order, call 800-531-3746 ext.1

2

Color



Black



Silver

3

Links

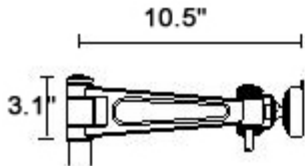

One 8" Standard Link

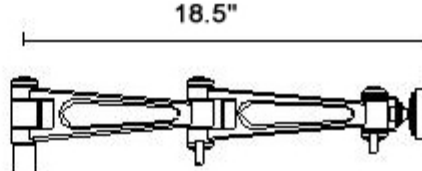

Two 8" Standard Links

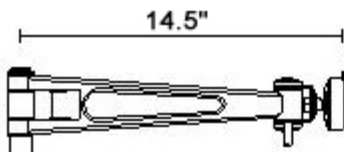

One 12" Long Link

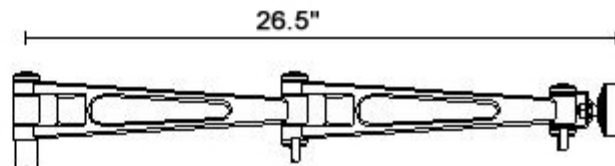

Two 12" Long Links

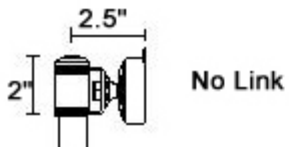

No Link

To place an order, call 800-531-3746 ext.1

# 4

## Mount

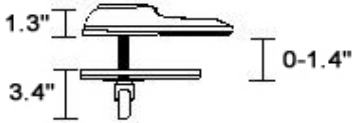
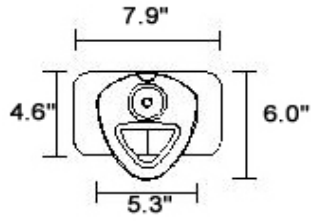

**Bolt-through**

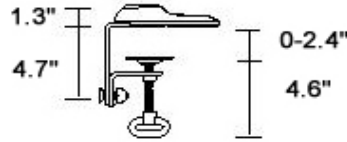
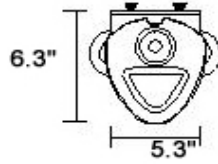

**Clamp**

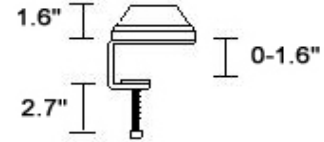
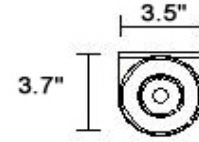

**Low Profile Clamp**

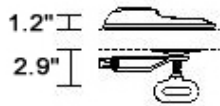
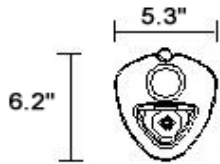

**Grommet**

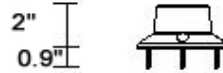

**Direct**

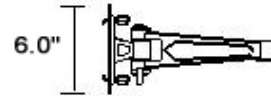
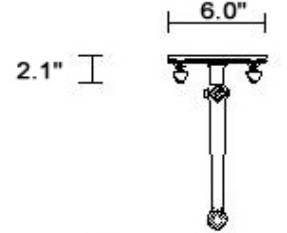

**Fixed Slatwall**

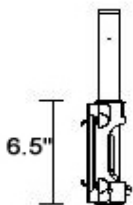

**Slatwall**

Multiple monitor option with double arm extensions

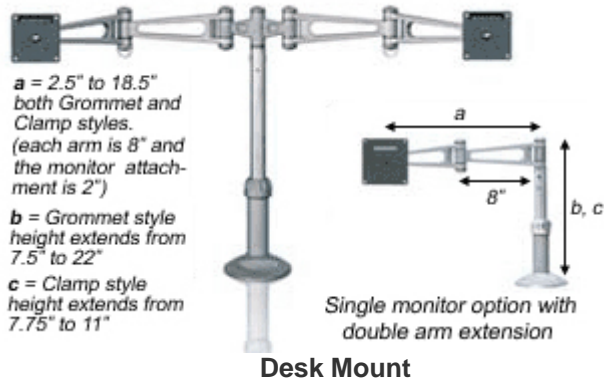

Wall Mount

5

Height

	Top Mount 1 Row	Top Mount 2 Rows	Bracket Mount 1 Row	Bracket Mount 2 Rows
<b>Grommet Mount</b>	21.9"	n/a	19.1"	32.4"
<b>Bolt, Direct &amp; Clamp Mounts</b>	18.5"	n/a	17.8"	36.7"
<b>Slatwall Mount</b>	15.1"	n/a	20.2"	28.2"

6

Adjustment

- Cylinder for 2-9 lbs
- Cylinder for 7-13 lbs (for 15" and 17" Monitor sizes)
- Cylinder for 11-18 lbs (for 19" Monitor size)
- Cylinder for 16-23 lbs (for 21" Monitor size)
- Cylinder for 22-28 lbs
- Cylinder for 28-34 lbs
- Cylinder for 34-40 lbs
- Fixed Post (No Cylinder)

7

Security

Security - All arms with security require special tools to remove monitor or to disassemble monitor arm

Quick Release – allows for quick installation and removal of monitor

To place an order, call 800-531-3746 ext.1

# 8

## Monitor Attachment

### Front End Adjuster (FEA)

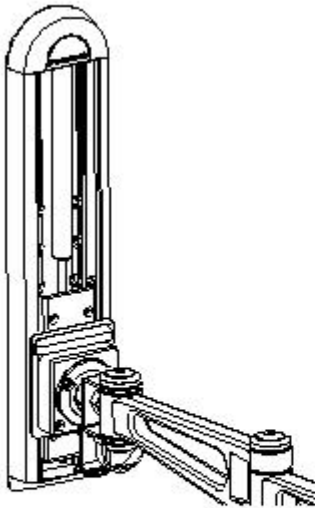

- 15" monitors (5 - 10 lbs)
- 17" monitors (9 - 15 lbs)
- 19" monitors (11 - 17 lbs)
- 21" monitors (13 - 21 lbs)
- 23" monitors (16- 25 lbs)

### Standard ball Joint

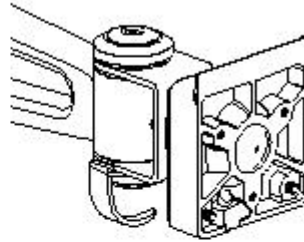

### Rotating (with Lock) RL

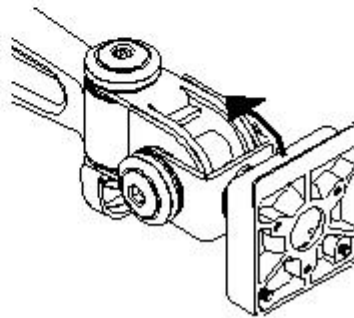

# 9

## Post Stop

Post Stop – limits the arms movement to 180 degrees in any direction

### Humanscale M7 Features:

- Saves valuable desk space
- Adjusts effortlessly in all directions to provide ideal monitor positioning for different tasks or users
- Gas-spring height adjustment minimizes risk of back injury
- Die-cast aluminum frame structure creates unmatched stability
- Installs quickly and easily through grommets or onto desk edge
- Built-in cable management
- Environmentally-friendly: Made of 100% recycled aluminum and packaged in recycled paper products

To place an order, call 800-531-3746 ext.1

### **Humanscale M7 Specification:**

- Comes standard with both 75mm and 100mm VESA mounting brackets
- 360° monitor rotation for portrait or landscape viewing
- 60° range of lateral and vertical monitor tilt for additional viewing adjustability
- Gas-spring calibrated to support monitors weighing 7 to 18 lbs
- Grommet mount fits desks up to 7" thick. Clamp mount fits desks up to 2 1/2" thick
- 10-year warranty on all gas-spring arms. Lifetime warranty on all other components

**To place an order, call 800-531-3746 ext.1**

