



B1710N/B1710P

50mm Weather Proof IR CAMERA



Features

- 1/3 inch Sony Super HAD CCD
- Normal Resolution : 480 TV Lines
- Built-in Fixed (f=6.0mm)
- Built-in IR LED(12EA) and Sensor(1EA)
- Min Illumination : Night(0.00Lux, IR LED On)
- Weather Proof Housing
- 50mm in Diameter



DIMENSIONS

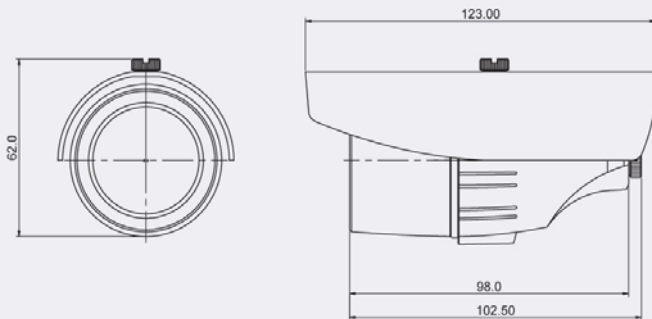

SPECIFICATIONS

Model	B1710N	B1710P
Signal System	NTSC	PAL
Scanning System	2:1 Interlace	
Scanning Frequency (H)	15.734 KHz	15.625 KHz
Scanning Frequency (V)	59.94 Hz	50 Hz
Image Sensor	1/3 Inch SONY Super HAD CCD	
Total Pixels	811(H) x 508(V) 410K	795(H) x 596(V) 470K
Effective Pixels	768(H) x 494(V) 380K	752(H) x 582(V) 440K
Horizontal Resolution	480 TV Lines	
Video Output	Composite: 1.0V p-p, 75Ω, Unbalanced	
S/N Ratio	More than 48dB(AGC Off)	
Lens	Built-in Fixed Lens (f=6.0mm)	
Min.Illumination	Day (0.3Lux), Night(0.00Lux, IR LED On)	
IR LED and Sensor	IR LED 12EA (850nm, 30°), Sensor 1EA	
IR LED Visible Range	Max. 15m	
White Balance	Auto	
Shutter Speed	1/60~1/10,000 sec.	1/50~1/10,000 sec.
Supplied Voltage	DC 12V	
Dimensions	62.0 x 123.0mm	
Weight	Approx. 600g	