

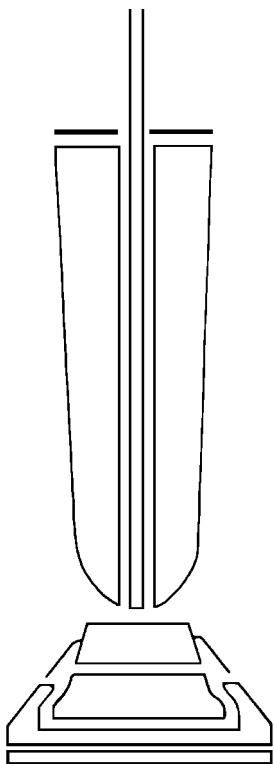



Sanitaire®

QUICK KLEEN®

COMMERCIAL UPRIGHT VACUUM CLEANER OWNER'S GUIDE 800 SERIES

Index

Important Safeguards	2
General Information	6
Assembly	6
Use	8
Fan Chamber	10
Dust Bag	11
Brush Roll Belt	12
Brush Roll (chrome steel)	13
Brush Roll (anodized aluminum)	14
Headlight	14
Warranty	15

Rating Plate

The model, type, and serial numbers are indicated on the rating plate located on the underneath side of the cleaner. For prompt and complete service information, always refer to these numbers when inquiring about service.

MODEL	TYPE	SERIAL NO.
VOLTS	AMPS.	HERTZ
SERVICE INFORMATION: 1-800-282-2886		

Model & Type _____

Serial No. _____

For location of nearest
Eureka/Sanitaire Warranty Station
or service information call
1-800-282-2886.

IMPORTANT SAFEGUARDS

When using an electrical appliance, basic precautions should always be followed, including the following:

READ ALL INSTRUCTIONS BEFORE USING THIS VACUUM CLEANER.

WARNING

To reduce the risk of fire, electric shock, or injury:

- Do not use outdoors or on wet surfaces.
- Do not leave vacuum cleaner when plugged in. Turn off the switch and unplug the electrical cord when not in use and before servicing.
- Do not allow to be used as a toy. Close attention is necessary when used by or near children.
- Use only as described in this manual. Use only manufacturer's recommended attachments.
- Do not use with damaged cord or plug. If vacuum cleaner is not working as it should, has been dropped, damaged, left outdoors, or dropped into water, return it to a service center before using.
- Do not pull or carry by cord, use cord as a handle, close door on cord, or pull cord around sharp edges or corners. Do not run vacuum cleaner over cord. Keep cord away from heated surfaces.
- Connect to a properly grounded outlet only (refer to Grounding Instructions).
- Do not use extension cords or outlets with inadequate current carrying capacity.
- Turn off all controls before unplugging.
- Do not unplug by pulling on cord. To unplug, grasp the plug, not the cord.
- Do not handle plug or vacuum cleaner with wet hands.
- Do not put any object into openings. Do not use with any opening blocked; keep free of dust, lint, hair, and anything that may reduce airflow.
- This vacuum cleaner creates suction and contains a revolving brush roll. Keep hair, loose clothing, fingers, and all parts of body away from openings and moving parts.
- Do not pick up anything that is burning or smoking, such as cigarettes, matches, or hot ashes.
- Do not use without dust bag in place.
- Belt pulleys can become hot during normal use. To prevent burns, avoid touching the belt pulley when servicing the drive belt.
- Use extra care when cleaning on stairs.
- Do not use to pick up flammable or combustible liquids such as gasoline, or use in areas where they may be present.
- Store your cleaner indoors in a cool, dry area.
- Keep your work area well lighted.
- Unplug electrical appliances before vacuuming them.

SAVE THESE INSTRUCTIONS

Grounding Instructions

This appliance must be grounded. If it should malfunction or breakdown, grounding provides a path of least resistance for electric current to reduce the risk of electric shock. This appliance is equipped with a cord having an equipment-grounding conductor and grounding plug. The plug must be plugged into an appropriate outlet that is properly installed and grounded in accordance with all local codes and ordinances.

DANGER

Improper connection of an equipment-grounding conductor can result in risk of electric shock. Check with a qualified electrician or service person if you are in doubt as to whether the outlet is properly grounded. Do not modify the plug provided with the appliance. If it will not fit the outlet, have proper outlet installed by a qualified technician.

This appliance is for use on a nominal 120 volt circuit and has a grounding plug that looks like the plug illustrated in Figure A. A temporary adapter which looks like the adapter illustrated in Figure B may be used to connect this plug to a two-pole receptacle, as shown, if a properly grounded outlet is not available. The temporary adapter should be used only until a properly grounded outlet, Figure A, can be installed by a qualified electrician. The green colored rigid ear, lug, or the like extending from the adapter must be connected to a permanent ground such as a properly grounded outlet box cover. Whenever the adapter is used, it must be held in place by a metal screw.

NOTE: In Canada, the use of a temporary adapter is not permitted by the Canadian Electrical Code.

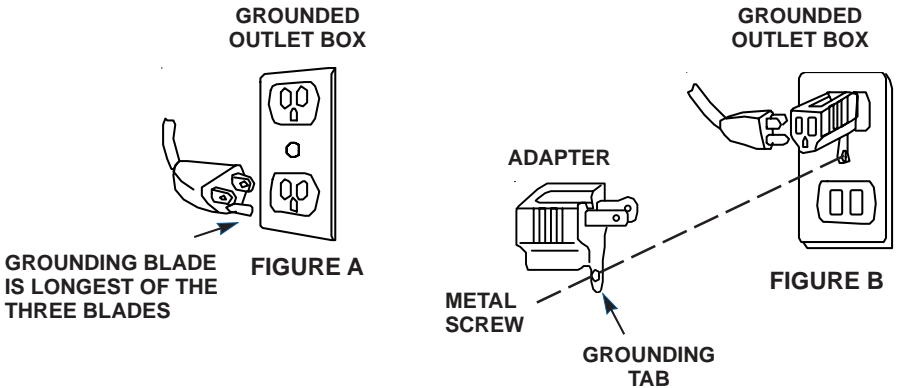

CONSEILS DE SÉCURITÉ

Lors de l'utilisation d'un appareil électrique, quelques précautions élémentaires doivent être observées, incluant les suivantes:

LISEZ TOUTES LES INSTRUCTIONS AVANT D'UTILISER VOTRE ASPIRATEUR.

AVERTISSEMENT

Pour réduire le risque de feu, de choc électrique, ou de blessure:

- Ne pas utiliser à l'extérieur ou sur des surfaces mouillées.
- Fermez le commutateur et débranchez l'appareil lorsque vous ne l'utilisez pas ou avant le nettoyage ou l'entretien.
- Ne permettez pas qu'il soit utilisé comme jouet. Une attention particulière est nécessaire lorsque utilisé par ou près d'un enfant.
- Suivez les recommandations d'utilisation de ce manuel. Utilisez uniquement les accessoires recommandés par le fabricant.
- Ne pas utiliser si le cordon ou la fiche sont endommagés. Si l'aspirateur ne fonctionne pas comme il le devrait, s'il a été échappé, s'il est endommagé, s'il a été laissé à l'extérieur ou échappé dans l'eau, retournez-le à un centre de service avant de utiliser.
- Ne pas le tirer ou le transporter par le cordon, ne pas utiliser le cordon en guise de poignée. Ne pas fermer une porte sur le cordon ou tirer le cordon sur des coins ou bordures pointus. Ne pas circuler sur le cordon avec l'aspirateur. Tenir le cordon à distance des surfaces chauffantes.
- Branchez toujours l'aspirateur dans une prise à trois (mise à la terre).
- Ne pas utiliser des rallonges ou des prises qui n'ont pas de capacité suffisante pour transporter le courant.
- Fermer tous les contrôles avant débrancher.
- Ne pas débrancher en tirant sur le cordon. Pour débrancher, tenez la fiche et non le cordon.
- Ne pas manipuler la fiche ou l'aspirateur avec les mains mouillées.
- Ne pas rien insérer dans les ouvertures. Ne pas utiliser si des ouvertures sont bloquées; assurez-vous qu'elles soient dégagées de poussière, mousse, cheveux ou toute autre chose qui pourrait réduire le passage de l'air.
- Cet aspirateur crée de la succion et contient un rouleau-brosse tournant. Tenir les parties mobiles et les ouvertures loin des cheveux, du linge, des doigts et de toute partie du corps.
- Ne pas ramasser des objets qui brûlent ou fument comme les cigarettes, allumettes ou cendres chaudes.
- N'utilisez pas sans le sac de poussière en place.
- Les poulies du courroie peuvent devenir chaudes pendant l'utilisation normale. Pour prévenir des brûlures, évitez de touché la poulie du courroie lorsque vous réparez la courroie.
- Portez une attention particulière lorsque vous nettoyez les escaliers.
- Ne pas utiliser pour ramasser des liquides inflammables ou combustibles comme de l'essence: Ne pas utiliser dans les endroits où ces liquides pourraient être présents.
- Entreposez votre aspirateur à l'intérieur dans un endroit propre et sec.
- Maintenez un bon éclairage à l'endroit où vous travaillez.
- Débrancher les appareils électrique avant de les balayer.

CONSERVEZ CES INSTRUCTIONS

INSTRUCTIONS VISANT LA MISE À LA TERRE

Cet appareil doit être mis à la terre. En cas de défaillance ou de panne éventuelles, la mise à la terre fournit au courant un chemin de moindre résistance qui réduit le risque de choc électrique. Cet appareil est pourvu d'un cordon muni d'un conducteur de terre et d'une fiche avec broche de terre. La fiche doit être branchée dans une prise appropriée correctement installée et mise à la terre conformément aux règlements et ordonnances municipaux.

AVERTISSEMENT

Un conducteur de terre mal raccordé peut entraîner un risque de choc électrique. Consulter un électricien ou un technicien d'entretien qualifié si vous n'êtes pas certain que la prise est correctement mise à la terre. Ne pas modifier la fiche fournie avec l'appareil-si elle ne peut être insérée dans la prise, faire installer une prise adéquate par un électricien qualifié.

Note. Au Canada, l'utilisation d'un adaptateur temporaire n'est pas autorisée par le Code canadien de l'électricité.

Cet appareil est destiné à un circuit de 120 V et est muni d'une fiche de mise à la terre semblable à celle illustrée par le Figure A. S'assurer que l'appareil est branché à une prise de courant ayant la même configuration que la fiche. Aucun adaptateur ne devrait être utilisé avec cet appareil.

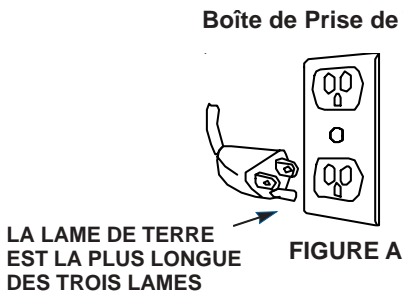

GENERAL INFORMATION

The cleaner is designed to pick up dirt and dust particles. Avoid picking up hard or sharp objects with the cleaner to prevent bag tears, hose clogs, and fan blade breakage with subsequent motor damage.

Service Information

The instructions in this booklet serve as a guide to routine maintenance. For additional service information telephone our toll free number for the nearest Eureka/Sanitaire Authorized Warranty Station. Refer to The Sanitaire Commercial Warranty for complete service information. **You should know the model, type and serial numbers when you call:**

USA: 1-800-282-2886

Mexico: 5670-6169

Canada: 1-800-282-2886



DO NOT OIL the motor or the brush roll at any time. The bearings are permanently lubricated and sealed.

Assembly Packet is with owner's guide.

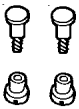

A
2-Part
Bolt

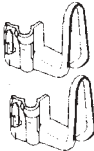

B
Cord
Hooks



C
Bag
Screws

HOW TO ASSEMBLE

The assembly packet contains two 2-part bolts, 2 bag screws and two cord hooks. An extra drive belt is also included with some models.

Step 1

Assemble the Handle

Slip the upper handle and the lower handle together so the handle bolt holes align and the slots in the handle are positioned as shown in Detail A. Insert a 2-part bolt (A) in the center of the handle and tighten.

Hold the assembled handle so it curves away from the cleaner. Then push the handle into the handle socket (D) at the rear of the cleaner. Align the holes, insert the other 2-part bolt (A), and tighten.

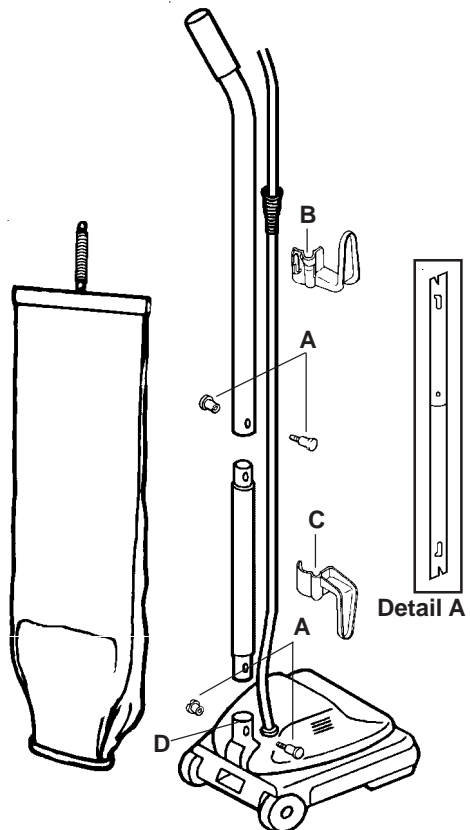

Step 2 Attach Upper Cord Hook

Pull the spring on the electrical cord upward toward the top of the handle. Make sure slots in handle are positioned properly, see below.

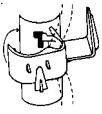

1. Place inner tab into slot

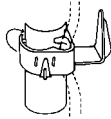

2. Press hook around handle

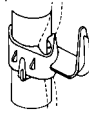

3. SNAP opposite inner tab into place

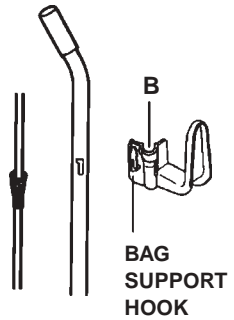

Insert the lower half of the spring into the upper cord hook (B), as shown. Snap the hook into the upper handle, directions below.

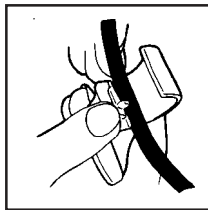
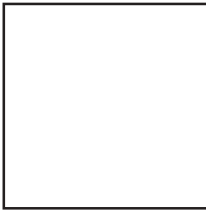

Step 3 Attach Lower Cord Hook

Make sure cord hook is pointing downwards. Press the power cord into the groove on the cord hook pulling any slack toward the base of the cleaner. On the cord hook, find the curved tab and place in slot on lower handle section, keep cord taut while pressing the cord hook to the left until it snaps into slot on opposite side of handle. The hook should point downward on the same side that the cord exits the hood.

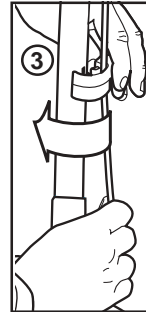
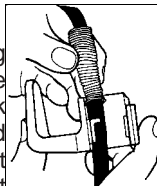

Step 4 Attach Outer Bag

Important: To provide a good gasket seal, the bag coupling must seat firmly against the motor base.

Hold outer bag with zipper away from the handle. Line up screw holes. Start the bag screws by hand, then tighten with a screwdriver.

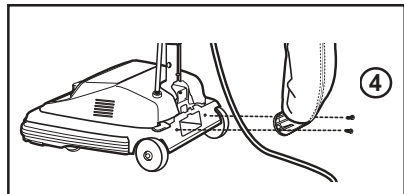

Loop the bag spring onto the bag support hook located at the back of the upper cord hook.

HOW TO ASSEMBLE (continued)

Step 5

Store Electrical Cord

The cleaner has two convenient cord storage hooks attached to the handle. Wind the cord around the hooks and fasten the plug to the cord to prevent unwinding.

HOW TO USE

The upright vacuum cleaner is designed to be used on multiple types of carpeting. **Do not attempt to use the upright vacuum cleaner on bare floors**, as damage to the floor covering may result. Above the floor cleaning tools are available (optional).

Handle Adjustment

With the tip of the foot, press down to release the handle lock located at the left rear side of the cleaner. Move the handle and adjust it to the desired position for (1) storing upright, (2) operating the cleaner at a comfortable height for the user, and (3) cleaning underneath low furniture.

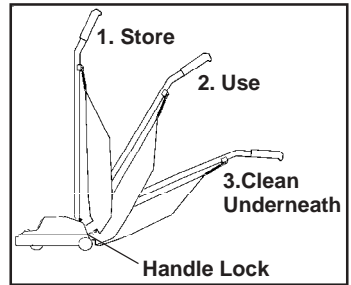

Power Switch

The power switch is mounted on the motor hood near the handle. Switch style varies by model and may differ from the illustration. A push with the foot turns the motor ON; push again to turn the motor OFF.

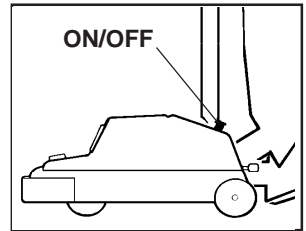

Edge Kleener®

Edge Kleener feature provides for improved cleaning of carpets near walls and stationary furniture. Slots on the sides of the nozzle increase air flow to the edges of the cleaner and add to the cleaning efficiency of the cleaner. To operate, simply run cleaner along edge board. Edge Kleener operates instantly and automatically.





Cleaner Height Setting

WARNING: Avoid injury. Keep loose clothing, hair, fingers, and all other parts of body away from any moving part (such as the revolving brush). Turn off the switch and unplug the cleaner before changing the cleaner height setting.

Adjust the vacuum cleaner height setting to match the carpet pile height. Refer to the following chart of recommended settings for carpet types.

The front of the cleaner has either a knob or slide adjustment which raises or lowers the cleaner base to match the type of carpet. With the cleaner cord unplugged, set the adjustment according to the table as a starting point. **While the cleaner is off and disconnected from the outlet**, place the handle in the operating position, tilt the cleaner back to remove the weight

from the wheels, and adjust the setting. Then plug the cleaner into the electrical outlet, turn on the switch, lower the handle, and pass the cleaner over the carpet. If the cleaner is still difficult to push, follow the procedure and test the cleaner at the next higher setting. Continue testing the setting until the cleaner is comfortable to move. Moving the knob or slide to the next higher setting raises the brush roll slightly, making the cleaner easier to push. However, the brush roll must make contact with the carpet for effective cleaning.

Recommended Setting	Example of Carpet
Position 1 	Low pile as kitchen, indoor, outdoor
Position 2 	Sculptured
Position 3 	Plush or thick sculptured
Position 4 	Thick plush
If the cleaner has additional height settings, they are for thicker carpets or where easier pushing is desired.	

HOW TO MAINTAIN

The instructions given in this booklet serve as a guide to routine maintenance. To avoid unnecessary service calls, check the bag, belt and brush roll often.

Quick Kleen® Fan Chamber

NOTE: Turn off the switch and unplug the electrical cord before cleaning.

The clear, removable fan chamber cover provides easy inspection, cleaning, and maintenance of the fan chamber. Removing the cover provides easy access to the motor fan. Grease buildup, dirt, or other obstructions, visible through the fan cover, should be removed. To clean the fan area, take off the chrome bottom plate by releasing the two cam locks (see Brush Roll Belt, Figure 1 and 2). Remove the belt from the motor pulley, then loosen and remove the screws on either side of the fan cover, as indicated by the arrows. Push the cam locks outward against the wheels to lift the cover from the cleaner base. Dirt and obstructions can easily be cleared; however, caked grease may need to be scraped from the cover and the cleaner. If the fan does not turn freely, it also should be removed for cleaning. To remove the fan, place a wrench over the motor pulley. Hold the fan blades with one hand and turn the wrench counterclockwise. Remove the motor pulley and lift the fan off the motor shaft. Clean the area and replace the fan over the motor shaft. Tighten the motor pulley snugly clockwise with the wrench. If necessary, replace the fan cover or the gasket with replacement parts.

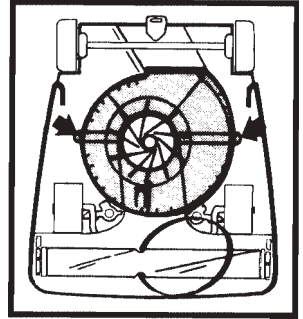

Be sure the gasket is in place. Reposition the fan cover by first placing the exhaust end into place between the large rear wheels. Seat the fan cover firmly. Next replace the belt and bottom plate as the pressure from the bottom plate helps seal the fan cover. Start the two screws by hand to be sure they are straight, then tighten.

Order fan chamber cover replacement kit (fan cover, gasket, two screws) Part No. 52334.

Cleaner Care

NOTE: Turn off the switch and unplug the electrical cord before cleaning unit.

To keep the vacuum cleaner looking new, it can be wiped with a damp cloth and a mild soap solution, then thoroughly dried. Never use any type of chemical as chemicals can damage the cleaner. When not in use, the cleaner should be stored in a clean, dry place.

HOW TO MAINTAIN



The instructions given in this booklet serve as a guide to routine maintenance. To avoid unnecessary service calls, check the bag, belt and brush roll often.

Disposable Dust Bags

Paper bags play a very important role in the efficiency of a vacuum cleaner. The purpose of a paper bag is to trap dirt. But at the same time the paper bag must be porous enough to allow air to pass through. If the paper bag becomes clogged, no air can pass through the cleaner and no cleaning can take place, regardless of how powerful the unit. Change the dust bag frequently. Some fine particles can restrict airflow very quickly and will decrease performance even before the bag appears to be full. For that reason, when vacuuming carpet fresheners or cleaners, powder, plaster dust, or similar fine substances, the bag may need to be changed more often.

How To Change Disposable Dust Bag–Style F & G

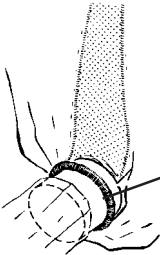
NOTE: Turn off the switch and unplug the electrical cord before changing dust bag. Never operate the vacuum cleaner without the dust bag.

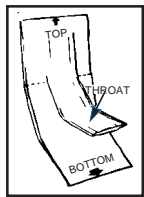
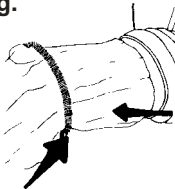
1. Pull zipper down.

2. Roll down coil spring.

3. Pull bag throat off sleeve.

4. Unfold new bag.

5. Place bag throat on sleeve.

6. Roll up coil spring.
7. Place paper bag into outer bag.
NOTE: Be certain there are no folds at the top or bottom of the paper bag.
8. Lift zipper.

Look for the  symbol.

Ask for **GENUINE EUREKA** dust bags–Style F & G.

Micron Filter® Bag Care (Micron Filter Bag is standard on some models)

Because the Micron Filter Bag is an effective filter medium, occasionally trapped dust particles will need to be cleaned from the inside of it. The dust accumulation can be vacuumed out with another vacuum or the bag may be removed to shake out. If you desire, the bag may be hand laundered. The zipper on the bag should be down and the bag should remain right side out. Use warm water (150°F 65°C) and a mild detergent. Pre-soaking the bag in a laundry pre-soak is desirable for best cleaning results. Air dry thoroughly before using.

DO NOT USE AN AUTOMATIC WASHER OR DRYER as either will cause abrasion to the delicate polyester fabric. **DO NOT DRY CLEAN** as dry cleaning fluids will damage plastic parts of your bag assembly.

Brush Roll Belt

The brush roll belt on the upright vacuum cleaner drives the brush to agitate, sweep, and comb the carpet nap. The belt should be checked regularly to be sure it is in good condition. Replace the belt if it is stretching, cracking, or slipping. Cut away any hair or thread wound around the brush roll or the belt pulley because the buildup could cause the belt to rotate unevenly.

How to Replace A Worn Belt

NOTE: Turn off the switch and unplug the electrical cord before replacing belt. Belt pulleys can become hot during normal use. To prevent burns, avoid touching the belt pulley when servicing the drive belt.

IMPORTANT: Improper installation of the brush roll or brush roll belt could cause carpet or cleaner damage.

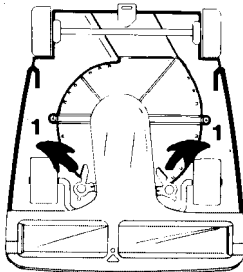

1. Release cam locks to remove bottom plate.
2. Pull up on belt to rotate it off the motor pulley. Lift up on brush roll and remove worn belt.

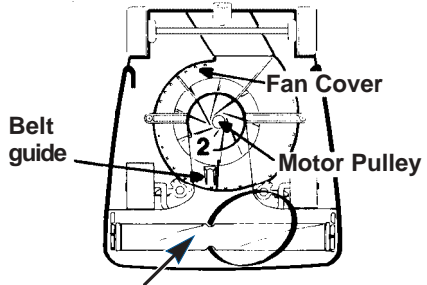

Check for brush wear (see *Brush Roll instructions*).

3. Place new belt around brush roll.
4. Align brush roll pulley with belt guide.

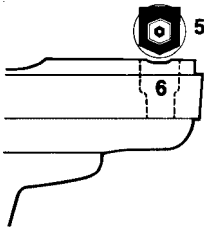

5. Place rubber end cap covers over both end caps (flat side against end cap). Align holes and secure.
6. Align end caps with slots in cleaner base. Push brush roll into base.

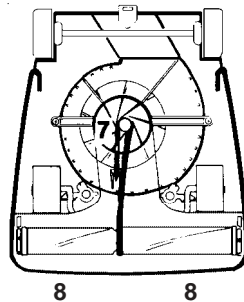

7. Place lower side of belt into belt guide and pull to stretch the belt around the left side of motor pulley. Rotate pulley to secure belt into groove.
8. Place slots of bottom plate over tabs of cleaner base. Seat and secure cam locks (refer to 1).

Ask for **GENUINE EUREKA** replacement belts - No. 52100.



Look for the  symbol.

Brush Roll

The rotating brush roll sweeps and combs the carpet nap. Keep the brush roll free from hair and threads so it will continue brushing the carpet nap. Replace worn brush strips when the bristles no longer touch a piece of cardboard held across the bottom plate. There are two types of brush rolls, the chromed steel tubular brush roll or the anodized aluminum spiral brush roll. Follow the instructions for the type of brush roll featured on the cleaner.

NOTE: Turn off the switch and unplug the electrical cord before replacing brush strips.

How To Replace Worn Brush Strips (chromed steel tubular)

New brush strips are supplied in sets of two, one long and one short. To replace, remove bottom plate and belt (see How To Change Belt). Then, grasp center of brush roll and lift to remove.

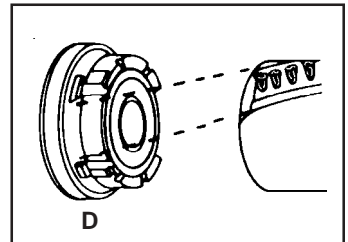
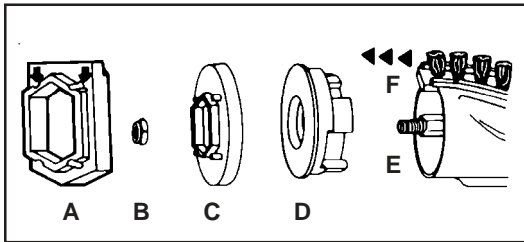

- A. Remove rubber end cap cover from one end
- B. Unscrew locknut
- C. Remove end cap
(sleeve bearing brush roll assembly includes a shaft washer, not pictured)
- D. Remove bearing retainer
- E. Push shaft through opposite end
- F. Pull out worn brush strip with pliers.
- F. Slide in new brush strip of same length (rounded end first) Fit track on either side into brush roll slot.
Replace second brush strip from opposite end of brush roll.
- E. Replace shaft
- D. Align indentation on bearing retainer with brush strip on both ends of brush roll
(replace shaft washer on sleeve bearing assembly)
- C. Position end cap with flat sides of center hole over flat sides of threaded shaft
- B. Tighten locknut
- A. Align holes and secure rubber end cap cover flat side against end cap

When properly assembled, the brush roll should rotate freely between the two end caps. Check the condition of the belt; change if necessary. Replace the brush roll, belt, and bottom plate (see How To Replace A Worn Belt).

**Ask for GENUINE EUREKA replacement brush strip
12 inch No. 52282; 16 inch No. 52246-1**

How To Replace Worn Brush Strips (anodized aluminum spiral)

New brush strip inserts are supplied in sets of two, one long and one short. To replace, remove bottom plate and belt (see How To Change Belt). Then, grasp center of brush roll and lift to remove.

- A. Remove rubber end cap cover from one end
- B. Unscrew locknut
- C. Remove end cap
- D. Press down on the brush strip and push out. Slide in new brush strip of same length, clip first, until clip locks into place. Replace second strip from opposite end. (*double bristle brush roll requires two sets of brush strips.*)

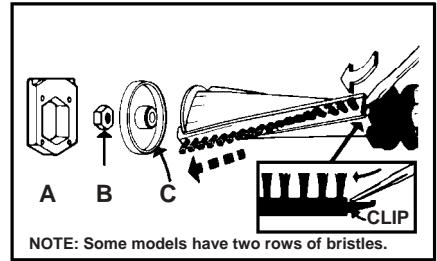

- C. Position end cap so flat side of center hole is over flat side of threaded shaft
- B. Tighten locknut
- A. Align holes and secure rubber end cap cover (flat side against end cap)

When properly assembled, the brush roll should rotate freely between the two end caps. Check the condition of the belt; change if necessary. Replace the brush roll, belt, and bottom plate (see How To Replace A Worn Belt).

Ask for Genuine Eureka replacement brush strip.

12 inch—No. 52140; 16 inch—No. 52264

Order two sets for double bristle brush rolls.

Headlight Bulb (Standard on most models)

NOTE: Turn off the switch and unplug the electrical cord before replacing headlight bulb.

Headlight style varies by model. Locate the notches that release the tabs at either (1) top, (2) side, or (3) bottom of the lens, as illustrated. Place a screwdriver into one notch; twist or pry the screwdriver to release the lens. Repeat for the second notch on the opposite side.

Rotate the bulb socket forward. Push bulb in and turn to remove. Secure new bulb into socket and rotate bulb socket backward.

Replace the lens tabs into the top or the bottom of the hood opening. Rotate lens to position and press down at each notch until the lens locks into position.

NOTE: Use 25 watt replacement bulb, only.

Ask for GENUINE EUREKA replacement bulb, 40009A.

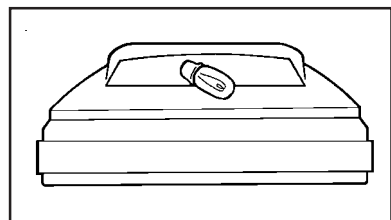
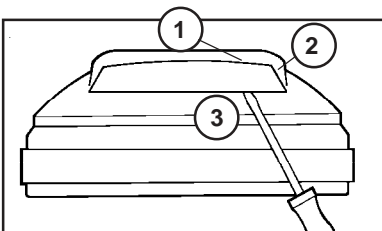

THE SANITAIRE® COMMERCIAL LIMITED WARRANTY

WHAT THIS WARRANTY COVERS

Your Sanitaire commercial cleaner is warranted to be free from all defects in material and workmanship in normal use FOR A PERIOD OF ONE YEAR. The warranty is granted only to the original purchaser of the cleaner. The warranty is subject to the following provisions.

WHAT THIS WARRANTY DOES NOT COVER

- Parts of the cleaner that require replacement under normal use, such as bumpers, bags, bristle strips, belts, light bulbs, hoses, impellers, outer bags and cleaning.
- Damages or malfunctions caused by negligence, abuse, or use not in accordance with the Owner's Guide.
- Defects or damages caused by unauthorized service or the use of other than Genuine Eureka parts.

WHAT THE EUREKA COMPANY WILL DO

The Eureka Company will, at its option, repair or replace a defective cleaner or cleaner part that is covered by this warranty. As a matter of warranty policy, the Eureka Company will not refund the consumer's purchase price.

WARRANTY REGISTRATION

Please fill out and return the warranty registration card accompanying your cleaner.

—continued on reverse side—

OBTAINING WARRANTY SERVICE

To obtain warranty service you must return the defective cleaner or cleaner part along with proof of purchase to any Eureka/Sanitaire Authorized Warranty Station. You will find the nearest location in the Yellow Pages under "Vacuum Cleaners—Service and Repair." Be certain that the Warranty Station is "Eureka/Sanitaire Authorized".

For the location of the nearest Eureka/Sanitaire Authorized Warranty Station or for service information, telephone toll free:

USA: 1-800-282-2886

Mexico: 5670-6169

Canada: 1-800-282-2886

If you prefer, you can write to:

The Eureka Company

Service Division

807 North Main Street

Bloomington, IL 61701, USA

In Canada write to:

The Eureka Company

866 Langs Drive

Cambridge, Ontario N3H 2N7

If it is necessary to ship the cleaner outside your community to obtain warranty repair, you must pay the shipping charges to the Eureka/Sanitaire Authorized Warranty Station. Return shipping charges will be paid by the Warranty Station. When returning parts for repair, please include the model, type, and serial numbers from the data plate on the cleaner.

FURTHER LIMITATIONS AND EXCLUSIONS

Any warranty that may be implied in connection with your purchase or use of the cleaner, including any warranty of MERCHANTABILITY or any warranty for FITNESS FOR A PARTICULAR PURPOSE is limited to the duration of this warranty. Some states do not allow limitations on how long an implied warranty lasts, so the above limitations may not apply to you.

Your relief for the breach of this warranty is limited to the relief expressly provided above. IN NO EVENT SHALL EUREKA BE LIABLE FOR ANY CONSEQUENTIAL OR INCIDENTAL DAMAGES THAT YOU MAY INCUR IN CONNECTION WITH YOUR PURCHASE OR USE OF THE CLEANER. Some states do not allow the exclusion or limitation of incidental or consequential damages, so the above limitation or exclusion may not apply to you.

This warranty gives you specific legal rights. You may also have other rights which vary by State.



THE EUREKA COMPANY

Bloomington, Illinois 61701