



M 6

Tactical
Laser
Illuminator

Operator's Manual



INSIGHT
TECHNOLOGY
INCORPORATED
Ideas That Work.

MADE IN THE USA

TABLE OF CONTENTS

<u>Section</u>	<u>Page</u>
Warnings and Cautions.....	1
Safety Summary.....	4
M6 Tactical Laser Illuminator Parts Diagram.....	7
Mounting.....	9
Dismounting.....	11
Switch Operation.....	13
Zeroing Procedures.....	15
Focusing.....	17
Bulb Replacement.....	18
Battery Replacement.....	19
Maintenance.....	21
Serial Number.....	22
Warranty.....	23
Service.....	24

WARNINGS

1. Before handling any firearm with the M6 Tactical Laser Illuminator **read and understand** the entire contents of your firearm manual provided and the M6 Tactical Laser Illuminator manual, especially the safety precautions and procedures for safe firearms handling.
2. **Failure** to follow the correct safety precautions and safe firearms handling techniques outlined in your firearm and M6 TLI Operator's manuals when handling a firearm with the M6 TLI can result in serious injury, damage to property or **death**.
3. **Always** practice safe firearms handling techniques when handling a firearm with or without the M6 TLI.
4. **Never** point a firearm with or without the M6 TLI attached, at anything or anyone that you do not intend to shoot.
5. Once the M6 Tactical Laser Illuminator is attached to a firearm, the firearm will be pointed at anything that the M6 TLI is directed at. **Do not** point the M6 Tactical Laser Illuminator at anything or anyone that you do not intend to shoot. The M6 TLI is designed to produce a sufficient amount of light to allow someone in a low light environment to be safely illuminated and identified without

the need to point the M6 TLI light, and the attached firearm, directly at that individual. The light from the M6 TLI can be pointed in a safe direction at a wall, floor or ceiling and “bounced” onto the darkened silhouette for identification purposes, thus avoiding the need to point the firearm directly at an individual. The M6 TLI can be de-focused for wide-angle illumination.

6. The ON/OFF switch on the M6 TLI allows you to operate the switch **without** placing your finger inside the trigger guard. **Always** keep your fingers **off** the trigger and **outside** the trigger guard until you are ready to fire the weapon.
7. **Always** check to see the chamber of the weapon is empty or “clear” before attempting to mount or dismount the M6 TLI. Follow the “clearing” procedures as set forth in the manual for your firearm.
8. **Always** remove the M6 Tactical Laser Illuminator from the firearm when performing maintenance or cleaning on the M6 TLI or when replacing bulbs or batteries.
9. **Failure** to follow any of the safety warnings listed above when handling a firearm and or the M6 Tactical Laser Illuminator can be dangerous and can result in serious injury, damage to property or **death**.

10. **Do Not** operate the M6 TLI around cleaning solvents or flammable/combustible materials. Avoid use of the M6 Tactical Laser Illuminator in environments involving a flammable atmosphere or gasses, such as evaporated gasoline. **Do Not** use the M6 TLI in areas where gasoline, paints and solvents or other flammable liquids are stored.
11. The M6 TLI should be tested periodically during periods of non-usage to ensure its proper functioning. When anticipating usage of and reliance upon the M6 Tactical Laser Illuminator, check the M6 TLI beforehand to ensure proper working order.
12. Proper functioning of the M6 TLI is dependent upon fully-charged batteries. Use care when handling batteries. Any battery may leak harmful chemicals which may damage skin, clothing or the inside of the M6 TLI. To avoid risk of injury, do not let any material leaked from a battery come in contact with eyes or skin. Do not expose batteries to excessive heat. Follow battery manufacturers' instructions as to proper handling, storage and disposal of batteries.
13. **CAUTION: Never** place the light on its face (bulb down) while ON. The bulb generates intense heat and could cause damage to the M6 TLI or the surface it is on.

SAFETY SUMMARY



LASER RADIATION - AVOID DIRECT EXPOSURE TO BEAM

VISIBLE LASER

Output Power: <5 mW

Wavelength: 640 \pm 40nm

Class IIIa Laser Product

- Do not stare into the visible laser beam.
- Do not look into the visible laser beam through binoculars or telescopes.
- Do not point the visible laser beam at mirror-like surfaces.
- Do not shine the visible laser beam into other individuals' eyes.
- Do not force adjusters beyond their intended travel.

SAFETY SUMMARY (continued)

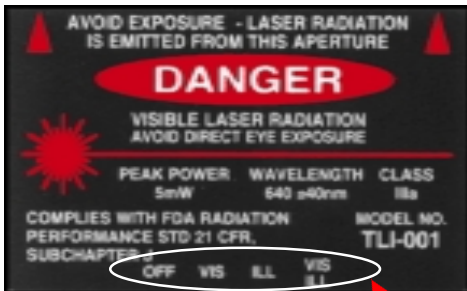

Modes

M6 Tactical Laser Illuminator Warning/Aperture/Mode Label

SAFETY SUMMARY (continued)

FOR THE LOCATION OF THE LASER WARNING LABEL ON THE UNIT SEE THE PHOTO BELOW.



WARNING

DO NOT STORE THE M6 TLI WITH BATTERIES INSTALLED.

CAUTION

DO NOT OVER TURN THE ADJUSTERS.

M6 TLI PARTS DIAGRAM

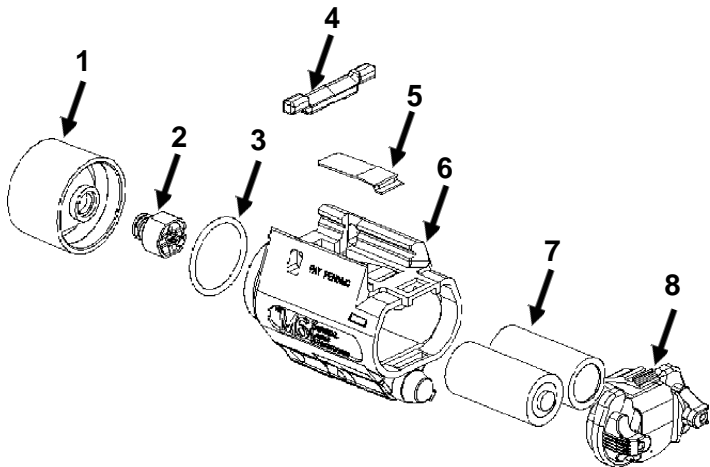

M6 TLI PARTS DIAGRAM (continued)

<u>Item No.</u>	<u>Description</u>	<u>Spare Part #</u>
1	Bezel	CFL-800
2	Bulb Assembly	CFL-700
3	O-Ring	HKL-018
4	Latch Bar	GLL-024
5	Latch Bar Spring	GLL-011
6	M6 Body	N/A
7	Batteries (Two - 3 Volt Lithium 123)	DL123 ABK
8	Backplate	GLL-003

MOUNTING



MOUNTING (continued)

1. With your **“cleared and safe”** firearm in your left or right hand, hold the M6 Tactical Laser Illuminator in the opposite hand with the light bulb facing in the direction of the muzzle of the firearm, away from your body and in a safe direction.
2. Bring the M6 TLI up and toward the firearm, aligning the grooves of the M6 TLI and the grooves on the firearm; slide the M6 TLI straight back until the latch engages into the locking slot located between the grooves of the firearm.
3. To check for positive engagement of the M6 TLI to the firearm, attempt to slide the M6 TLI forward. You should not be able to move the M6 TLI forward without disengaging the lock.
4. The M6 Tactical Laser Illuminator is now ready for use.

DISMOUNTING

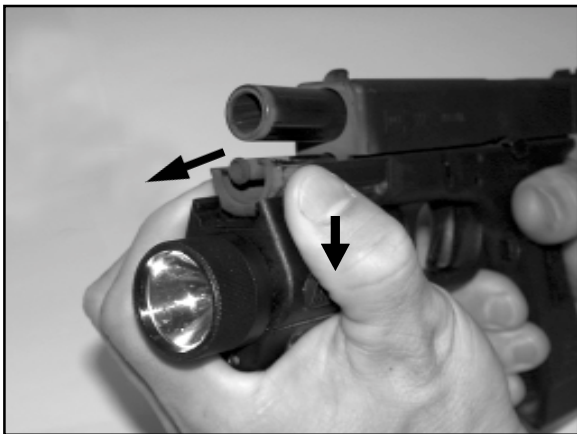

DISMOUNTING (continued)

1. Place your free hand under the M6 TLI with your index finger and thumb on each end of the latch bar.
2. Pull down with the index finger and thumb to disengage the latch bar from the weapon. With the latch bar pulled down, slide the M6 TLI forward and down until it is clear of the grooves on the firearm.

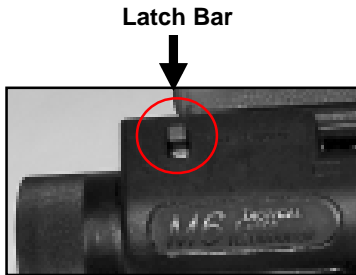

CAUTION

NEVER put your hand in front of the muzzle of a firearm. Make sure you push the M6 TLI forward down and away from the muzzle of the pistol.

SWITCH OPERATION

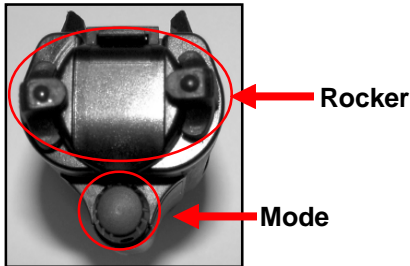

ROCKER:

The rocker switch is part of the backplate and no attempt should be made to disassemble it. The rocker switch has two positions, MOMENTARY and STEADY ON. For momentary operation, on the **right side** of the trigger guard, **push the switch up** with the trigger finger. **(Keep your finger away from the trigger until you are ready to fire)**. The switch will stay ON until you release the upward pressure of the trigger finger on the switch. The switch will return to the OFF position upon release.

To keep the M6 TLI illuminated continuously, press down on the switch on the right side with the trigger finger **(Keep your finger away from the trigger until you are ready to fire)**. The light will stay ON until you push up on the switch.

SWITCH OPERATION (continued)

ROCKER (continued):

The left side of the switch is operated with the left trigger finger or “OFF” thumb (**Keep your finger away from the trigger until you are ready to fire**). For momentary operation, press down on the switch with your left trigger finger or “OFF” thumb.

For continuous operation, press up on the switch with your left trigger finger or “OFF” thumb (**Keep your finger away from the trigger until you are ready to fire**). The light will remain on until you push down on the switch.

CAUTION

Never place the light on its face (bulb down) while ON. The bulb generates intense heat and could cause damage to the M6 TLI or the surface it is on.

MODE SWITCH:

The M6 TLI comes with a rotary Mode Selection Switch. There are four (4) positions to select from depending on the intended mode of operation. Each mode is indicated on the bottom of the Warning Label. While looking at the label, the first position is “OFF”, the second is “VIS”, the third is “ILL”, and the fourth is “VIS/ILL”.

The following is the operational mode when the rocker switch is activated.

OFF - The system is completely inoperable in this mode.

VIS - Only the visible laser operates.

ILL - Only the white flashlight operates.

VIS/ILL - Both the visible laser and white flashlight operate together.



ZEROING PROCEDURES

WARNINGS

Before handling any firearm with the M6 TLI read and understand the entire contents of your firearm manual provided and the M6 TLI manual, especially the safety precautions and procedures for safe firearms handling.

Always check to see the chamber of the weapon is empty or “clear” before attempting to mount or dismount the M6 TLI. Follow the “clearing” procedures as set forth in the manual for your firearm.

Be sure of your target and background before firing. When you squeeze the trigger, you must expect the pistol to fire and you must take full responsibility for firing it.

Zeroing the M6 TLI using a 25 meter range and target.

Visible Aiming Beam

1. Set up a target at 25 meters with a clearly visible aiming point.
2. Mount the M6 TLI onto the weapon's accessory mounting rail (see “Mounting” Procedures).
3. Select the “VIS” operating mode using the mode switch knob on the back of the M6 TLI.
4. Turn ON the visible laser aiming point by rotating the ON/OFF rocker switch to one side until it clicks ON (see “Switch Operation” procedures).

ZEROING PROCEDURES (continued)

Zeroing the M6 TLI using a 25 meter range and target (continued).

5. While aiming the pistol through the iron sights, use the provided adjuster tool (hex wrench) to adjust the visible aim point of the M6 TLI by turning the adjusters, as needed, to superimpose the beam's aiming point over the weapon's iron sight aim point. Refer to the figure below.
6. Aim and fire a three round shot group into the center of the target aiming point at 25 meters.
7. Compare the impact point of the shot group to where the beam's aiming point was on the target to ensure they line up.
8. Make the necessary adjustments to the beam to ensure it's aiming point and the shot group are aligned.
9. Turn the unit OFF.

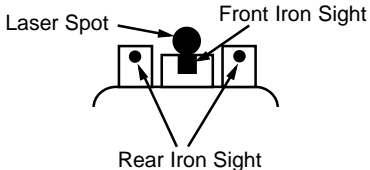

FOCUSING

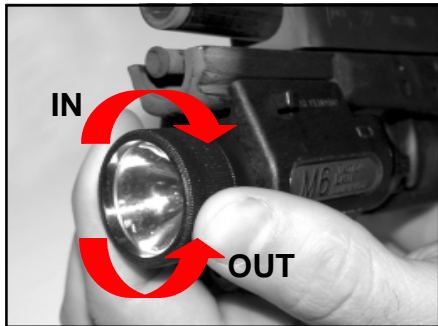

To focus the beam of the M6 Tactical Laser Illuminator, simply turn the bezel until the desired focus is reached. Be careful not to unscrew the bezel from the body.

CAUTION

DO NOT place your hand in front of the muzzle of the firearm when turning the bezel.

BULB REPLACEMENT

Turn the bezel counter clockwise until it can be removed from the main body. There is a slight spring pressure as the bezel comes free of the retaining threads. Remove the old bulb from the M6 TLI as shown in the photo. Insert the new bulb into the space provided. Reinstall the bezel by rotating clockwise.

NOTE: Manufacturer recommends periodically cleaning all electrical contacts with an alcohol wipe to optimize light performance (see “Maintenance” procedures for more information).



CAUTION

Be careful to ensure proper thread engagement when reinstalling the Bezel. Failure to do so will strip the threads on the main housing. Only replace the bulb when the M6 Tactical Laser Illuminator is detached from the firearm.

BATTERY REPLACEMENT

CAUTION

Insight Technology recommends that you **DO NOT** store the M6 TLI with batteries in the unit.

Be sure to let the Bulb Assembly cool prior to servicing.

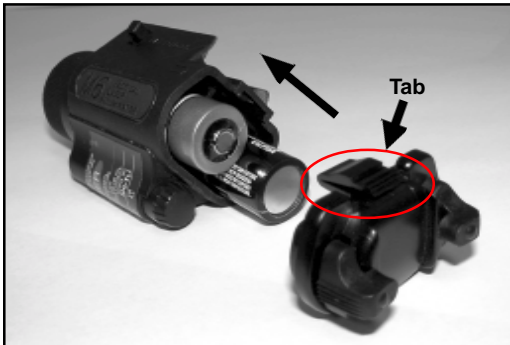

BATTERY REPLACEMENT (continued)

1. With the unit dismounted from the gun, hold the M6 TLI in one hand and with the thumb of the free hand, press down on the tab located at the top center of the backplate.
2. While depressing the tab, pivot the backplate away from the body of the M6 TLI.
3. The batteries may now be removed from the body of the M6 TLI by tipping the bezel upward and allowing the two 3-Volt Lithium 123 batteries to slide out.
4. To replace the two 3-Volt Lithium 123 batteries notice the raised markings on the outside of the main body to indicate battery orientation. Point the positive end of the battery forward and place into the right side of the battery cavity. The negative end of the 3-Volt Lithium battery goes forward and into the left side of the battery cavity.
5. Place the lip of the backplate into the small groove in the bottom of the M6 body and pivot upward until the latch engages into the rectangular hole and a “click” can be heard.
6. Make sure the light is functioning by manipulating the switch either up or down. The light should come ON. If not, check to make sure that the backplate is secure. If the light still does not operate, remove the backplate and check to see that the positive end of the battery in the M6 TLI is on the left side and the negative end of the battery is on the right side, see photo.

MAINTENANCE

WARNINGS

Always check to see the chamber of the weapon is empty or “clear” before attempting to mount or dismount the M6 TLI. Follow the “clearing” procedures as set forth in the manual for your firearm.

**Make sure the weapon is clear and on SAFE before proceeding.
Let bulb assembly cool prior to servicing.**

Maintenance of the M6 TLI:

1. Clean the M6 TLI by rinsing with water and wiping with a soft cloth. Such cleaning should be done whenever the M6 TLI becomes dirty or after exposure to salt water.
2. To clean the aiming and illumination beam windows, wipe using a soft cloth with clean water, alcohol, or general purpose window cleaner.
3. To prevent a buildup of muzzle blast on the flashlight lens ONLY, a small amount of oil or lubricating solvent can be rubbed on the exterior glass lens. After shooting, cleaning becomes much easier.
4. For replacement bulbs, part #CFL-700, contact the dealer where you purchased your light or contact Insight Technology directly to locate a stocking distributor.

IDENTIFICATION NUMBER

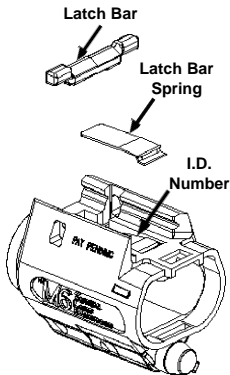

1. While holding the M6 TLI in the palm of your hand, press down with your thumb directly onto the latch bar spring. Doing so will relieve the force against the latch bar.
2. With the opposite hand, push on one end of the latch bar so as to slide the latch bar out the side of the M6 body.
3. With the latch bar removed, lift up on the latch bar spring to remove.
4. Notice the number on the M6 body in the area underneath the latch bar spring.
5. To restore the M6 TLI to its proper operating condition, perform steps 1-3 in reverse order.

NOTE: The notched area on the bottom of the latch bar must line up with the latch bar spring. If the two parts are not properly aligned, the latch bar will easily move side to side with minimal finger pressure.

LIMITED WARRANTY

INSIGHT TECHNOLOGY INCORPORATED

12 MONTH LIMITED WARRANTY

Insight Technology Incorporated warrants for 12 months after purchase that its products will be free from defects in material and workmanship. Insight Technology Incorporated will repair or replace, at its option, any product or part (with the exception of the lamp and battery) which is found to be defective under normal use and service, without charge. Insight Technology Incorporated's obligation to repair or replace, at Insight's option, shall be the purchaser's sole and exclusive remedy under this warranty. Warranty does not cover battery leakage. Contact battery manufacturer in this event.

This warranty extends only to the original owner. There are no warranties, express or implied, other than as set forth on this page, and Insight Technology Incorporated disclaims any warranties of merchantability or fitness for a particular purpose. Insight Technology Incorporated shall not be liable for incidental, consequential or special damages arising out of or in connection with product use or performance. For service or repair, return unit UPS prepaid with a copy of the sales receipt to Insight Technology Incorporated.

SERVICE: THE M6 TACTICAL LASER ILLUMINATOR

For service or repair, please call for an authorization number before returning unit. Send via UPS prepaid with a copy of the sales receipt to:

Insight Technology, Inc.
3 Technology Drive
Londonderry, NH 03053

ATTN: COMMERCIAL SALES

Phone: 603-626-4800 / Fax: 603-647-7234
www.insightlights.com

The exportation of this product is subject to the International Traffic and Arms Regulations (ITAR) 22CFR120-130.
NOTE: The commodity jurisdiction of this product is currently under review by the U.S. State Department and the U.S. Commerce Department.



3 Technology Drive, Londonderry, NH 03053
Phone 603-626-4800 Fax 603-647-7234
www.insightlights.com