

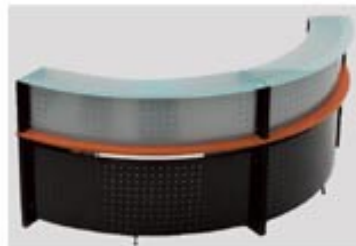









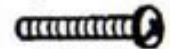

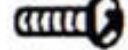
Assembly Instructions for Components:  
 OZ821T - 60 Degree Desk  
 OZ821CR - 60 Degree Riser  
 OZ823T - Small 90 Degree Desk  
 OZ823CR - Small 90 Degree Riser  
 OZ824T - Large 90 Degree Desk  
 OZ824CR - Large 90 Degree Riser  
 OZ827T - 55"W Straight Desk  
 OZ827CR - 55"W Riser



## Parts List:

A 4 Sets 	B Qty 2  <b>M6x110</b>	C Qty 8  <b>M6x45</b>
D Qty 2  <b>M6x25</b>	E Qty 8  <b>M6x16</b>	<del>F Qty 16  <b>M6x12</b></del>
G Qty 4 	H Qty 8 	I Qty 2 
J Qty 1 	K Qty 4 	<del>L Qty 4 </del>

Special Note: You will not use the (F) screws or (L) brackets. Please disregard/discard those parts.

Tools needed: Phillips screwdriver and a helper.

Each section of your reception desk consists of two components: The reception glass top riser (cartons labeled "CR") and the desk (cartons labeled "T"). Begin with the reception riser assembly (CR cartons) shown in diagrams 1-2.

Reception Counter Assembly:

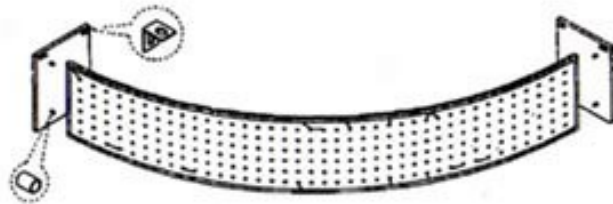

1

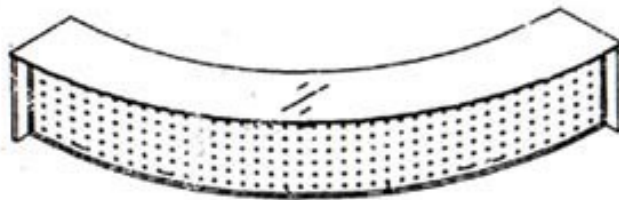

2

Diagrams 1-2:

Identify the left and right hand reception riser side panels and curved silver perforated metal front panel. (Front panel will be straight in case of 827) Attach the L-Shaped Brackets (K) to the top of each side panel using the 16mm (E) screws. Next, use four 45mm (C) screws through the holes in the end of the back panel, through the chrome cylinders (H) and into the inserts in the left and right side panels.

Once complete, attach the glass counter by aligning the holes of the outer silver pucks on the underside of the glass counter with the L-Shaped brackets (K) and attaching with the 4 screws (E). Washers are supplied if needed for spacing between the screw and pucks of the glass counter.

**Important:** Please note that some of the curved silver front panels (OZ821CR/823CR/824CR) may have a 2-sided tape adhered over the center holes that attach the center pucks that are pre-attached to the underside of the glass counter. This tape is to be used to ease assembly as the curvature of the panel can sometimes cause slight misalignment with the center pucks.

Desk Assembly: Cartons Labeled as "T"

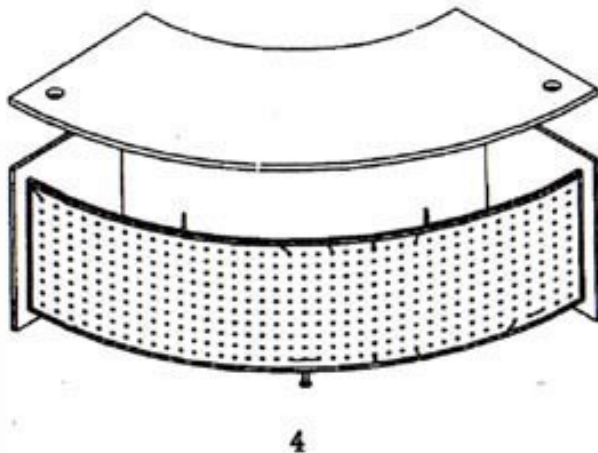
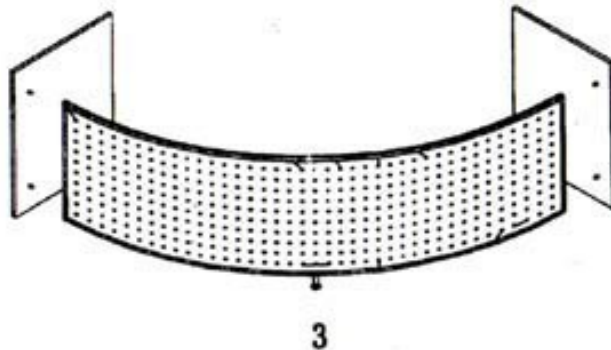

**Diagram 3**

Identify the left and right hand side panels and curved (or straight as on 827T) black perforated metal front panel. Connect the adjustable foot (G) into the insert in the middle of the black metal panel using 2 the (D) screws.

Next, screw in 2 leveling glides (G) into both the left and right side panels.

Next, attach the black perforated front panel to the left and right side panels by using four 45mm screws (C) through the holes in the end of the black front panel, through the chrome cylinders (H) and into the inserts in the left and right side panels.

**Diagram 4**

Attach the main work surface using 4 of the cam lock and cam pin sets (A). Screw 4 cam pins into the underside of the desktop in the holes provided. Set the desktop into position on the left and right side panels, guiding the cam pins into the holes on the side panels. Once in position, insert the 5/8" diameter cam locks into the holes and turn approx. half a turn to lock and pull in the work surface to the left and right legs. After attaching the desktop, use the two "I" cylinders and two 110mm (B) screws through the underside of the front panel inside edge, through the "I" cylinders and into the inserts of the underside of the desktop. **3**

Desk Assembly: Cartons Labeled as "T"

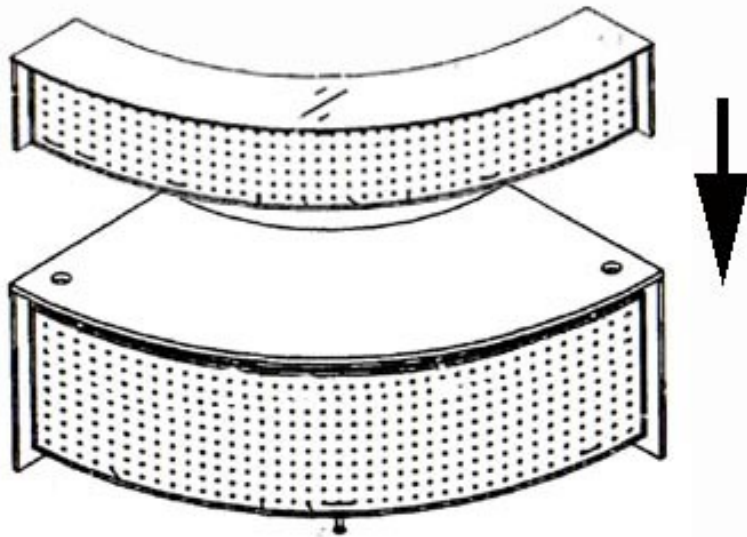

**5**

## Diagram 5

Attach reception counter to desk using 4 of the cam lock and cam pin sets (A). Set cam pins into left and right sides of desktop. Once in position, insert the cam locks into the holes on the left and right side panels. Give the cam locks a half turn to secure the riser and desktop together.

See our assembly video on our YouTube Channel!

Desk assembly video:

[http://youtu.be/Gy1fOUEd\\_4M?list=UUmntgpS2v69I\\_uJgiFAO4CA](http://youtu.be/Gy1fOUEd_4M?list=UUmntgpS2v69I_uJgiFAO4CA)

Riser assembly video:

[http://youtu.be/Eq9KmOD0Dvk?list=UUmntgpS2v69I\\_uJgiFAO4CA](http://youtu.be/Eq9KmOD0Dvk?list=UUmntgpS2v69I_uJgiFAO4CA)

Or, view the same assembly videos on our website at:

<http://modernofficefurniture.com/office-furniture-assembly-instructions/>

See How To Assemble Glass Top Desks  
and How To Assemble Glass Top Riser

**4**