

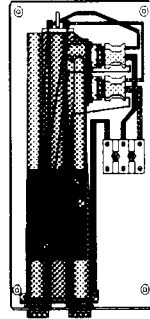

“Flow Controlled”



## ELECTRIC INSTANTANEOUS WATER HEATER INSTALLATION GUIDE AND OWNERS MANUAL

### WARNING

**BEFORE ATTEMPTING INSTALLATION OF THIS UNIT OR MAKING ANY ADJUSTMENTS TO THE UNIT, ALWAYS BE SURE CIRCUIT BREAKER IS OFF TO PREVENT DANGER OF SERIOUS ELECTRIC SHOCK. FAILURE TO GROUND THE SYSTEM MAY RESULT IN SERIOUS INJURY OR DEATH**

### INSTALLER/ CONSUMER RESPONSIBILITIES

READ THIS MANUAL CAREFULLY BEFORE ATTEMPTING TO INSTALL OR OPERATE THIS WATER HEATER. IF THE SAFETY RULES ARE NOT FOLLOWED, THE UNIT WILL NOT OPERATE PROPERLY AND IT COULD CAUSE DEATH, SERIOUS BODILY INJURY AND/OR PROPERTY DAMAGE. WARRANTY OF THIS WATERHEATER WILL DEPEND ON PROPER INSTALLATION AND OPERATION. THE WARRANTY WILL BE VOID IF THE DESIGN HAS BEEN ALTERED IN ANY WAY WHATSOEVER. THE MANUFACTURER OF THIS HEATER WILL NOT BE LIABLE FOR ANY DAMAGES BECAUSE OF FAILURE TO COMPLY WITH THE INSTALLATION AND OPERATING INSTRUCTIONS OUTLINED ON THE FOLLOWING PAGES.

THE INSTALLATION MUST CONFORM WITH THE INSTRUCTIONS IN THIS MANUAL AND LOCAL CODES, OR IN THE ABSENCE OF LOCAL CODES, WITH THE LATEST EDITION OF THE NATIONAL ELECTRICAL CODE. THIS PUBLICATION IS AVAILABLE FROM YOUR LOCAL GOVERNMENT, ELECTRIC CO., PUBLIC LIBRARY, OR BY WRITING UNDERWRITERS LABORATORIES, 333 PFINGSTEN RD., NORTHBROOK, IL. 60062

IF YOU REQUIRE HELP OR HAVE ANY QUESTIONS RELATING TO THE INSTALLATION OR PERFORMANCE OF THIS HEATER, PLEASE CALL OUR TECHNICAL SERVICE DEPARTMENT TOLL FREE: 1-800-543-6163. HAVE THE INFORMATION LISTED BELOW BEFORE CALLING:  
MODEL NO. \_\_\_\_\_ SERIAL NO. \_\_\_\_\_ INSTALLATION DATE \_\_\_\_\_

**Eemax Inc., 353 Christian St., Oxford, CT 06478**

1-800-543-6163 • 203-267-7890 • fax 203-267-7975 • e-mail: eemaxinc@aol.com

## **GENERAL**

The Eemax "Closed Outlet Flow Controlled" heater is specifically designed to take in cold water only and heat it to temperatures suitable for the normal domestic usage up to a maximum of 140°F. To obtain optimum performance and energy savings, the unit should be located as close as possible to the point of use. The unit is supplied with compression rings and nuts suitable for direct coupling to 1/2" copper or plastic piping. Do not use additional screwed fittings or pipe dope. Doing so will void the warranty. **DO NOT SOLDER PIPES WHILE THE UNIT IS INSTALLED** (serious damage to the electronic flow switch will result).

This heater must have its own independent circuit, using a correctly rated breaker and wires suitable for at least 75 °C operation.

Failure to ground this system may result in death or serious injury.

### **1) MOUNTING THE UNIT**

- 1) The unit should be mounted as close to the point of use as possible.
- 2) This unit must only be mounted in the vertical position with the water fittings at the bottom of the unit. Mounting other than in the vertical position WILL cause element burn out.
- 3) The cold water inlet is on the right hand side and the hot water outlet is on the left hand side. Under NO circumstances can these be reversed.
- 4) Leave a minimum of 8" above the unit for easy replacement of the element.
- 5) The heater should be fixed to the wall using the four mounting holes at each corner of the backplate.

NOTE: The heater should be installed below the level of all hot water outlets serviced by this heater.

#### **NOTE: PRESSURE RELIEF DEVICE**

This unit is not required by UL to have a Pressure and Temperature safety relief valve (PTRV). You should check with local codes to find out if one is required in your area.

If local codes require the use of temperature and pressure relief valve it should be installed on the outlet hot water pipe before the outlet ball valve.

## 2) PLUMBING HOOK-UP

1) The unit is supplied with compression fittings. USE THESE: DO NOT USE THREADED PIPE FITTINGS. DO NOT USE PIPE DOPE OR TEFLON TAPE ON THIS INSTALLATION. Ensure the inlet filter supplied with this unit is in place.

2) Take care to ensure that the pipes are correctly aligned with the inlet and outlet bosses in order to avoid excessive stress on the heater body molding.

NOTE: Run water through the supply pipe to remove all debris from the pipe before connecting the heater. Failure to do so could damage the flow switch.

3) Install isolating valves (full flow ball valve type) on both inlet and outlet pipes. This allows unit to be isolated for maintenance purposes. (Fig. 2)

4) When all plumbing is complete, fully check the system for water leaks at all plumbing connections. If leak is present take corrective action. If leak is at the compression fitting, slowly tighten compression nut until it stops. Fully open both inlet and outlet ball valves.

Run all hot water outlets fed by this heater one at a time for a minute or two until the water flow is continuous, free from "gulping" and from all visible air pockets.

Fig 1

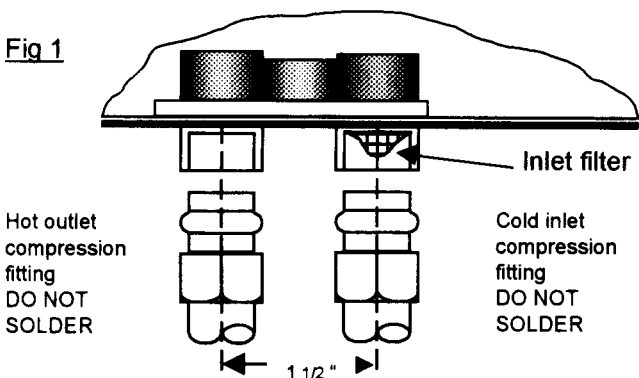

**NOTE:**  
ALL PLUMBING MUST BE COMPLETED BEFORE YOU  
PROCEED WITH THE ELECTRICAL HOOK-UP.

**TEST THE INSTALLATION FOR LEAKS BEFORE  
CONNECTING THE ELECTRICAL SUPPLY.**

### 3) ELECTRICAL HOOK-UP

**WARNING**  
**BEFORE BEGINNING ANY WORK ON THE INSTALLATION**  
**BE SURE THAT THE BREAKER IS "OFF"**  
**TO AVOID ANY DANGER OF SHOCK.**

Your Eemax heater must have its own independent circuit using insulated, UL listed, 3 wire cable of the appropriate size suitable for use up to 75 °C protected by the correctly rated circuit breaker.

#### RATINGS OF "EX" UNITS

MODEL	RATED VOLTAGE	MAXIMUM OUTPUT AT RATED VOLTAGE	AMPS DRAWN	TEMPERATURE RISE (F)		
				0.5 gpm	0.75 gpm	1 gpm
EX35*	240	3,500 W	15	48	32	24
EX55*	240	5,500 W	23	75	50	37
EX65*	240	6,500 W	27	88	59	44
EX75*	240	7,500 W	31	-	68	51
EX95*	240	9,500 W	39	-	86	65
EX60	277	6,000 W	22	81	55	41
EX80	277	8,000 W	29	-	73	55
EX90	277	9,000 W	33	-	82	61
EX100	277	10,000 W	36	-	91	68
EX8208	208	8,300 W	39	-	76	57

\* The heaters are rated at 240 Volts. If the actual voltage supplied is lower there will be a proportional drop in output.

- 1) Wire entry into the unit should be made through the lower right hand corner of the backplate via one of the two "knockout" holes provided.
- 2) The "mains" wires should be connected to the slots in the terminal block marked L1 and L2 or N. The ground lead **must** be connected to the slot marked . Failure to ground the system may result in death or serious injury.

**WARNING:**  
This water heater must not be switched "on" if there is  
a **possibility** that the water in the heater is frozen.

**FIGURE 2**

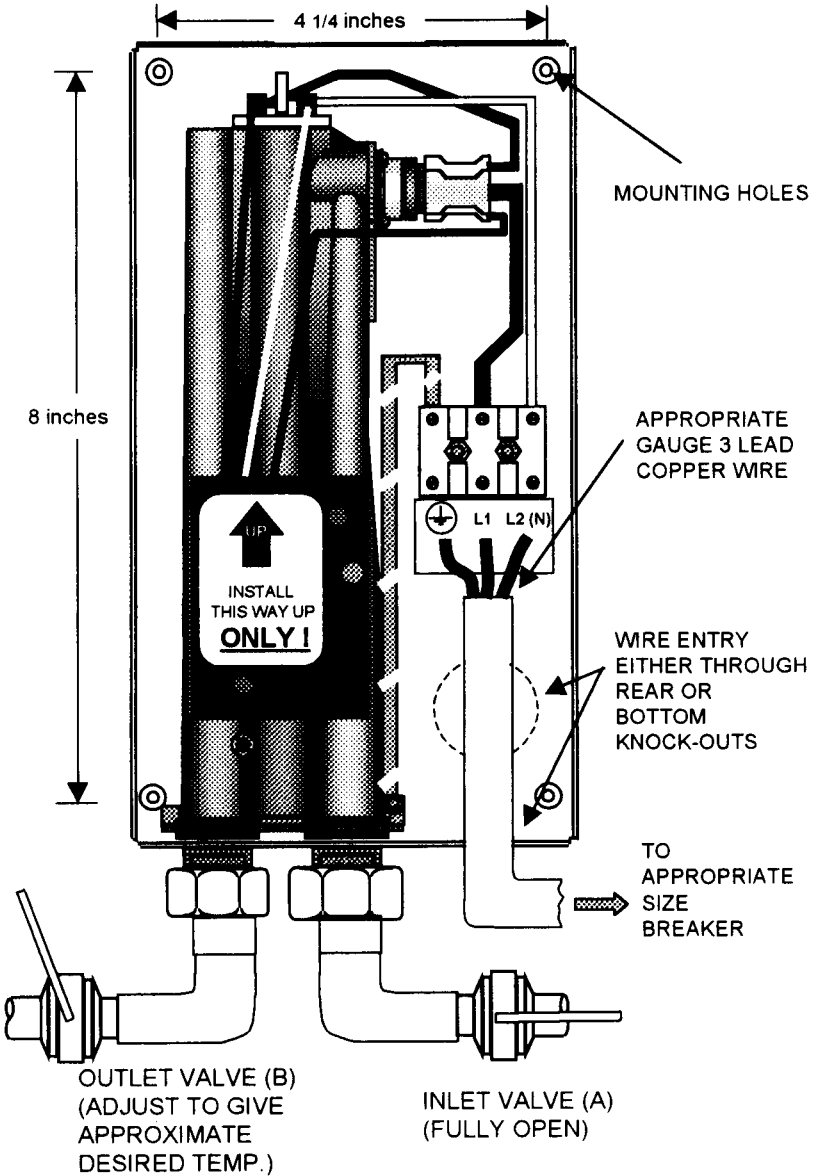

## 4) COMMISSIONING YOUR HEATER

### IMPORTANT

Before switching "on" the power at the breaker make sure that the hot water circuit is free of air pockets or premature failure of the heating element will occur. To do this open all hot water faucets one at a time for a minute or two until the water flow is continuous and free from "gulping" and from visible air pockets.

- 1) With inlet and outlet BALL VALVES fully open, turn on all hot water outlets.
- 2) Run for 5 minutes, turning faucet "on" and "off" repeatedly.
- 3) Switch on electric supply at breaker.
- 4) The power indicator light should now come on (see Fig. 1).  
NOTE: At this point water temperature may not be very hot.
- 5) Using the OUTLET BALL VALVE slowly reduce water flow until desired temperature is achieved at hot water outlet.

**NOTE: The water temperature is proportional to the flow through the heater. The lower the flow the higher the temperature and vice versa.**

- 6) Check performance of flow switch by opening and closing outlet valve a few times. The power indicator light should be on **ONLY** when water is flowing through the unit. For expected temperature rise at various rates of flow see chart.

**NOTE: An EX95 (9.5 kW) unit at 240 V will deliver 1 gallon per minute at 65°F temperature rise. For example, with incoming water temperature at 45°F the unit will produce 1 gallon per minute at 110°F.**

- 7) It is possible that drawing off cold water at comparatively high rates of flow elsewhere in the building at the same time that the heater is working, could cause premature element failure. Care should be taken not to starve the unit of cold water. To prevent this from happening, open fully the main valve on the cold supply to the building and throttle back the control valves to the other cold water outlets.

Note: EX65 "Twin" comes with two faucet mounted aerators, these should be mounted on both the faucets served by this unit. EX65 "Single" comes with one faucet mounted aerator and 3/8" compression fittings with integral flow restrictor.

## TROUBLE SHOOTING

### SYMPTOM: NO HEAT INDICATOR LIGHT OFF

#### 1) ELECTRIC SUPPLY IS OFF

Turn on the main breaker.

#### 2) NO OR LOW WATER FLOW

Ensure that the minimum flow rate to switch on your heater is met.

"EX100, 95, 90, 8208" Models minimum flow rate = 0.75 gals. per minute

"EX80, 75, 65" Models minimum flow rate = 0.6 gals. per minute

"EX60, 55" Models minimum flow rate = 0.5 gals. per minute

Also check that the inlet filter screen is clear from any debris. This is located in the brass inlet boss.

#### 3) WATER CONNECTIONS ARE REVERSED

Cold water inlet = right side, hot water outlet = left side.

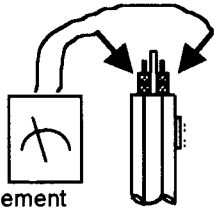

#### 4) ELEMENT BURNED OUT

TURN OFF THE breaker!

Using an ohmmeter test the resistance of the heating element across the two threaded termination rods on top of the element. The resistance reading should be under 10 ohms.

If the resistance is much greater than this value, call Eemax for a replacement element.

### SYMPTOM: NO HEAT OR LOW TEMPERATURE WITH INDICATOR LIGHT ON

#### 1) WATER FLOW TOO HIGH

Reduce the water flow by using an outlet ball valve. See page 3 for temperature rise at various flow rates.

#### 2) INCORRECT POWER SUPPLY

Make sure that the unit is connected to the voltage supply specified on the rating label on the the front cover of the unit and no other.

#### 3) ELEMENT BURNED OUT

TURN OFF THE breaker!

Repeat the steps from paragraph 4 above.

# Replacement Parts for "Flow Controlled" Units

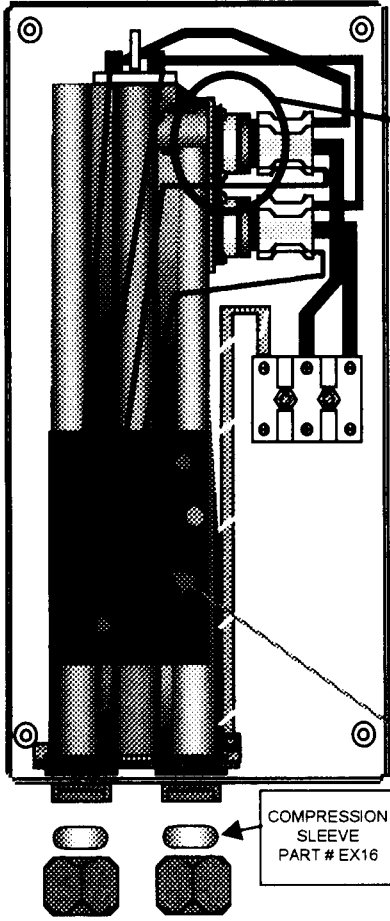

TRIAC  
PART # EX 18

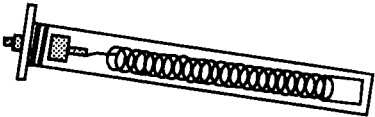

**ELEMENT CARTRIDGE**  
HEATER MODEL/ORDER REF    CARTRIDGE REF #

EX 35	EX 1650
EX 55	EX 1050
EX 65	EX 890
EX 75	EX 770
EX 95	EX 630
EX 8208	EX 520
EX 60	EX 1280
EX 80	EX 960
EX 90	EX 850
EX 100	EX 760

CONTROL BOARD  
EX101 for 240v, 208v  
EX08 for 277V

COMPRESSION  
SLEEVE  
PART # EX16

COMPRESSION  
NUT  
PART# EX17