



Owner's Manual

Visit [Gun Dog Supply.com](http://GunDogSupply.com)

Order a Dogtra Edge RT

See other Dogtra Products

Remote Controlled Dog Training Collars

dogtra **EDGE RT**



Dogtra Company

22912 Lockness Avenue
Torrance, CA 90501 U.S.A.

Tel 310.534.0101

Fax 310.534.9111

Toll Free 1.888.811.9111

Store Website shop.dogtra.com

Copyright © 2014 Dogtra Company All rights reserved. (1)



EDGE RT

By Dogtra
Remote Controlled Dog Training Collars

Owner's Manual

Please read this manual thoroughly before operating
the Dogtra EDGE RT training collar.

Product Safety and Health Statement

Proper e-collar use

Dogtra e-collars are intended for the sole purpose of behavior modification of dogs. They are NOT intended for human use or use on other animals. Dogtra Company does not assume any liability for the improper use of a Dogtra e-collar.

Aggressive dogs

Dogtra highly recommends consulting a dog training professional when using an e-collar to correct dogs that are aggressive towards other dogs or people.

Interference with other electronic devices

Dogtra's industry-leading technology filtering system ensures minimal interference with other electronic devices (garage door openers, mobile phones, etc.). Our digital microprocessor offers thousands of unique codes to eliminate frequency match-up with other Dogtra e-collars. Dogtra recommends consulting your physician if you are going to use the e-collar and you have any type of medical devices.

Inadvertent activation

If the constant button is held down for 12 seconds or more, the unit will automatically shut down. It reactivates when the button is released and depressed again.

Proper fit

A loose fit can allow the receiver/collar to move around on the dog's neck. When this happens, the contact points may rub the skin and cause irritation. If the unit is too loose, the contact points will not make proper contact and your dog will not receive consistent stimulation.

Duration your dog can wear the unit

Leaving the receiver/collar in the same location on the dog's neck for an extended period of time can cause skin irritation. If the dog is to wear the e-collar for long periods, occasionally reposition the receiver/collar so that the contact points are moved to a different location on the dog's neck. Make sure you check for skin irritation each time you use the unit. If your dog exhibits signs of skin irritation, consult with a veterinarian.

Reaction to the stimulation

Every dog has a different tolerance and reaction to the stimulation. Please look at your dog's reaction to find just the right level of stimulation. The stimulation level may vary depending on the situation and distractions. Normally a distracted dog (chasing another dog, squirrel, etc.) will require a higher level of stimulation compared to when there is no distraction.

Training methods

E-collars can be used with many different methods. If you have any concerns in the training methods provided by Dogtra, consult with a dog training professional.

Table of Contents

| | |
|---|----|
| At a Glance | 5 |
| Main Features of the EDGE RT | 6 |
| Overview | 7 |
| Understanding your training system | |
| 1. How to turn the EDGE RT on/off | 9 |
| 2. The Stimulation/Combination buttons | 10 |
| 3. How to use the dog selector dial | 12 |
| 4. Collar fitting | 12 |
| 5. How to find the right stimulation | 13 |
| 6. To maximize the distance | 13 |
| 7. The LED indicator | 14 |
| 8. Charging the battery | 14 |
| 9. How to change the length of the contact points | 16 |
| 10. Code setting | 17 |
| 11. How to attach the belt clip on the EDGE RT | 19 |
| 12. How to use the test light..... | 20 |
| General Training Tips | 21 |
| Maintenance | 23 |
| Troubleshooting Guide | 24 |
| Warranty and Repair Information | 26 |

At a Glance



Transmitter



Receiver/
Collar



Battery
charger



Splitter
cable



Owner's
Manual



Belt clip



Test light



Contact point
extension washer
/ adjustment tool

Optional accessories

Field auto charger

Dogtra's field auto chargers are designed for use with a 10-volt car outlet.

European charger

Dogtra's European chargers are designed for use with a 230V AC electrical outlet.

To purchase accessories, please visit Dogtra's online store at shop.dogtra.com or call customer service at 1-888-811-9111.

Main Features of the EDGE RT



Intensity selection dial stimulation level (1-8)



1-Mile range



Nick/Constant/non-stimulating Pager vibration modes



Stimulation/Combination buttons



User expandable to a three-dog system



Fully waterproof



Extendable contact points (5/8" to 3/4")



Belt clip



2-hour rapid charge batteries



Low/High Stimulation



For dogs as small as 35 lbs

Overview

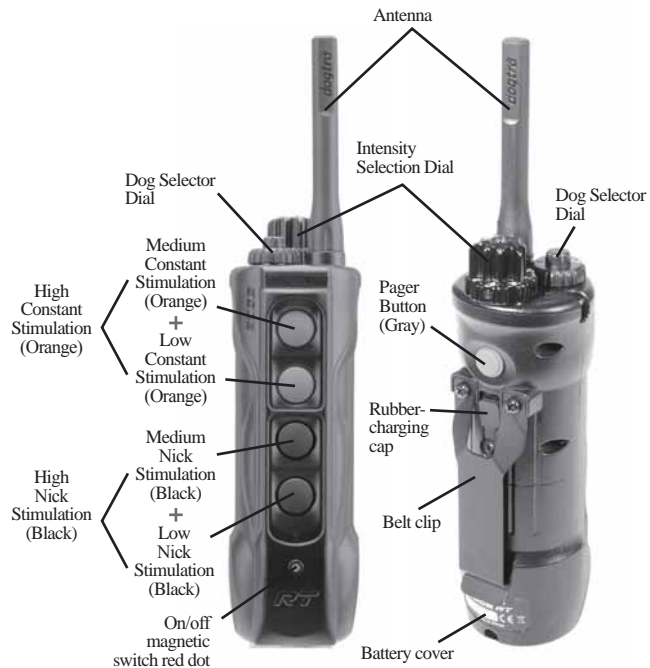

Transmitter

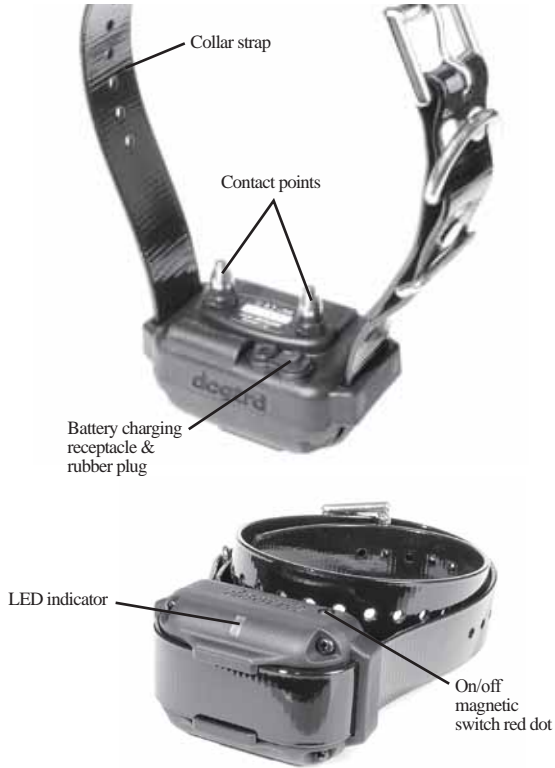

Receiver/Collar

Understanding your training system

1. How to turn the EDGE RT on/off

To activate the receiver/collar, place the red dot on the front of the transmitter to the red dot on the receiver/collar. Hold the two red dots together for a moment until the LED light on the receiver/collar comes on. While the receiver/collar is on, the LED light will blink every 4 seconds.

To deactivate the receiver/collar, repeat the same procedure holding the two red dots together momentarily. The LED light will turn red for a brief moment indicating that the receiver/collar is now shut off.

The handheld transmitter will turn on when a button is pressed and turn off automatically when not in use.



2. The Stimulation/Combination buttons

The handheld transmitter uses 4 buttons to send stimulation. The LED indicator will blink on both the handheld transmitter and the receiver/collar when the stimulation buttons are pressed.

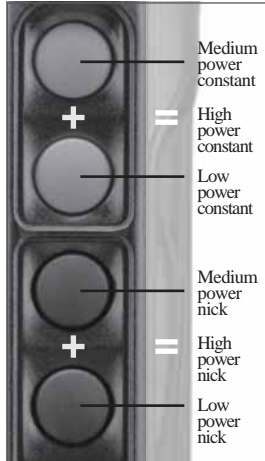

1) Constant Stimulation

The two orange buttons on the front of the transmitter control 3 levels of Constant stimulation.

- **Low Power Constant:** Press the lower orange button for Low Power Constant stimulation.
- **Medium Power Constant:** Press the top orange button for Medium Power Constant stimulation.
- **High Power Constant:** Press both orange buttons together for High Power Constant stimulation.

2) Nick Stimulation

The two black buttons on the front of the transmitter control 3 levels of Nick/momentary stimulation.

- **Low Power Nick:** Press the lower black button for Low Power Nick/momentary stimulation.
- **Medium Power Nick:** Press the top black button for Medium Power Nick/momentary stimulation.
- **High Power Nick:** Press both black buttons together for High Power Nick/momentary stimulation.



12 sec.

- * Holding down the constant stimulation buttons will activate for a maximum of 12 seconds. After 12 seconds of constant stimulation, the stimulation will reset. The stimulation reactivates once the constant button is released and pressed again.

3) Pager vibration

The Pager vibration button is located on the back of the handheld transmitter. The LED indicator will blink on both the handheld transmitter and the receiver/collar when the Pager button is pressed.

- * Holding down the Pager button will activate for a maximum of 12 seconds, until it is released and pressed again.



3. How to use the dog selector dial

The EDGE RT is expandable to use as a 3-dog system.



- **DOG 1:** Set the dial to 1 to control dog 1
- **DOG 2:** Set the dial to 2 to control dog 2
- **DOG 3:** Set the dial to 3 to control dog 3

4. Collar fitting

The receiver/collar should be fitted so that the surgical stainless steel contact points press firmly against the dog's skin.

When properly fitted, you should be able to fit a finger or two snugly in between the contact points and your dog's skin.

When properly fitted, the receiver/collar should not move on the dog. The best location for the receiver/collar box is either side of the dog's windpipe.

A loose fit can allow the receiver/collar to move around on the dog's neck. When this happens, the contact points may rub the skin and cause irritation. If the receiver/collar is too tight, the dogs may have difficulty breathing.

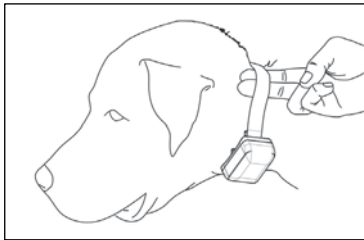

5. How to find the right stimulation

The stimulation intensity can be adjusted using the stimulation selector dial on top of the handheld transmitter.

There are 8 levels of stimulation intensity, with level 1 being the lowest level and level 8 being the highest.

The level of stimulation best suited for your dog depends on your dog's temperament and threshold for stimulation. Always start at the lowest level and work your way up. The appropriate level can be found when the dog responds to the stimulation with a mild reaction, such as a tensing of the neck muscles. The stimulation level may vary depending on the training situation. When highly distracted, dogs will require a higher level of stimulation.

6. To maximize the distance

The EDGE RT has a 1-mile range. The range may vary depending on the way the transmitter is held. Hold the transmitter away from your body to receive the greatest range. For maximum signal strength, keep the EDGE RT properly charged.

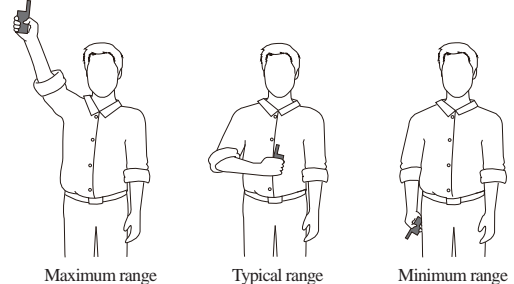

*Avoid touching the antenna or the range may decrease substantially.

7. The LED indicator

The LED indicator flashes every 4 seconds when the receiver is on and ready for use. The LED indicator will blink on both the transmitter and the receiver when the transmitter buttons are pressed.

The LED indicator color indicates the battery life level.

Green = Fully charged, **Amber** = Medium, **Red** = Needs charging

If the unit is used while the LED indicator is red, it will shut down automatically.



8. Charging the battery

1. Lift the rubber-charging cap and plug in the charger.
2. Plug the adapter's power plug in to a standard AC wall outlet.
The LED indicator on the transmitter and receiver/collar will turn red.
3. When the unit is fully charged, the LED indicator will turn green on both the transmitter and receiver/collar. Unplug the adapter's power plug from the AC wall outlet and disconnect the charger from the unit.
4. Place the rubber-charging cap back over the charging port.

* The transmitter and receiver/collar rubber-charging cap ensures dirt and debris does not build up in the charging port area. The unit is waterproof even if the rubber-charging cap is not fully closed.



Using the EDGE RT as a 2 or 3 Dog System

To charge multiple receivers/collars and a transmitter, combine additional splitter cables as shown above.

Connect 2 splitter cables together to charge all parts of a 2-dog system, or connect 3 splitter cables together to charge all parts of a 3-dog system, at the same time.

* **Warning**

1. Fully charge the unit before the first use.
2. Do not charge the unit near any flammable substances.
3. Fully charge the unit before storing for one month or longer.
4. Always use Dogtra approved charging adapters.

9. How to change the length of the contact points

The Dogtra EDGE RT comes equipped with standard 5/8" contact points that can be extended to 3/4" contact points, for use with dogs with longer coats.

To increase the contact point length from 5/8" to 3/4", follow the steps below.

1. Using the included adjustment tool with the side marked 5/8", unscrew the contact points counter-clockwise.
2. Place the contact point extension over the exposed threads, flat side down.
3. Place the contact points over the extensions and tighten the contact points and extensions clockwise using the adjustment tool with the side marked 3/4".

* Caution: Tighten until firmly in place. Be careful not to over tighten.

To shorten the contact points back to the standard 5/8", start with the adjustment tool with the side marked 3/4", remove the contact point extensions, and tighten the contact points with the adjustment tool with the side marked 5/8".

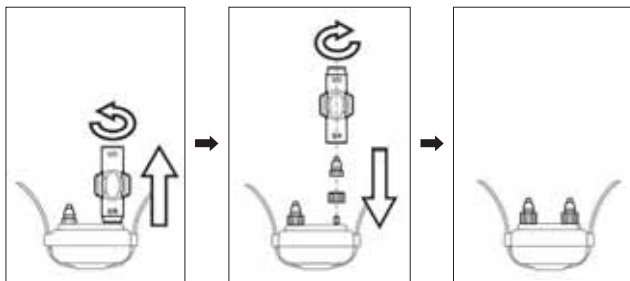

10. Code setting

To set the coding for the Dogtra EDGE RT transmitter to an existing receiver/collar, or an Additional receiver/collar, follow the steps below.



1. Set the stimulation dial to level 1, and select between dog 1, 2, and 3 with the dog selector dial on the handheld transmitter.



2. With the receiver/collar turned off, hold the red dot on the front of the transmitter to the red dot on the receiver/collar for about 5 seconds.



3. **IMPORTANT!** Place the receiver/collar aside when the LED indicator rapidly blinks green on the receiver/collar. Take caution not to touch the contact points on the receiver/collar during step 3 or you may receive an electric stimulation.



4. Within 5 seconds of separating the transmitter and receiver/collar, hold down the top orange/constant button on the front of the transmitter and the Pager button on the back of the transmitter at the same time. The code setting is complete when the LED indicator resumes blinking every 4 seconds on the receiver/collar.



Do not touch the contact points of the receiver/collar while code setting the EDGE RT. If you do so, you may receive an electric stimulation. Also, do not attempt to code set the device while the receiver/collar is in contact with dogs, other animals, or people.

11. How to attach the belt clip on the EDGE RT

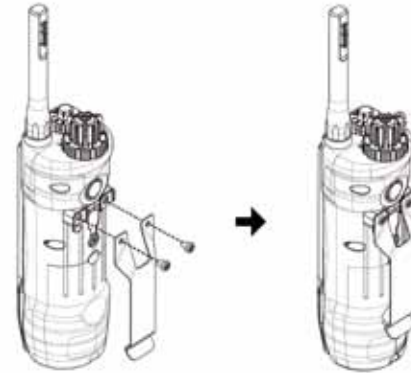

To attach the included belt clip to the transmitter, follow the instructions below.

1. Align the belt clip to the grooves on the back of the transmitter.
2. With a firm grip, screw on the belt clip using the provided Philips head screws.

Caution! Tighten until firmly in place. Be careful not to over tighten.

12. How to use the test light

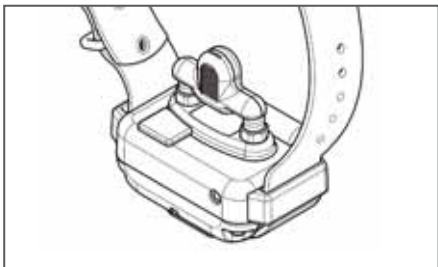

1. Turn on the receiver/collar and place the test light over the contact points as shown in the diagram.
2. The test light will illuminate momentarily when the Nick stimulation button is pressed on the transmitter. The light will stay lit as long as the Constant button is pressed on the transmitter, up to 12 seconds.
3. When the stimulation is increased, the test light will emit a brighter light.

General Training Tips

Getting started with your EDGE RT

Your dog must know some very basic obedience commands before beginning training with the EDGE RT. A dog learns by first being shown a command, followed by lots of repetition over an extended period. As the dog becomes proficient at these commands, the trainer can introduce distractions and different locations to strengthen them. Throw in the correct amount of positive and negative reinforcement and you should end up with a well-mannered dog.

Obedience training on the leash

Your dog must fully understand the obedience commands (sit, stay, here, heel and kennel) before using the e-collar for reinforcement of these commands. A leash attached to a standard collar is used to "teach" the dog the basic obedience commands (here, heel, sit, and stay). A tug on the leash/collar is used to reinforce the command. When the dog complies with the command, use positive reinforcement/praise. Once the dog understands these commands, the e-collar can be used to reinforce them.

Beginning e-collar training

When you feel your dog understands the obedience commands on the leash we can now start with the electric collar training. With the dog on the leash wearing the electric collar continue with your obedience drills. Light stimulation (nick or constant) is going to be applied as a command is given, the stimulation is removed as the dog complies. Through repetition, a dog learns to turn off the light stimulation by performing the command. E-collar training is another form of negative reinforcement,

similar to the leash and standard collar training. When the dog complies with the command, we use praise/positive reinforcement. The final step is the avoidance phase in which the dog learns that he can avoid the stimulation altogether by performing your commands. When these training procedures are complete, the electric collar is used as a reminder when the dog does not comply with your commands at home or in the field. Keep your initial training sessions short and positive. Dogs have a short attention span, especially young dogs.

How much stimulation to use

Always start with low levels of stimulation and work your way up depending on the disposition of your dog and any given situation. By using only enough stimulation to get your point across, you will have a more controllable environment and a dog that is under less stress. Animals (and humans) perform better in a less stressful environment.

For more training information, please visit our website at www.dogtra.com.

Maintenance

Basic maintenance

Be sure the rubber-charging cap is securely in place when the collar is in use. After each training session, carefully inspect the unit for any missing parts or damage to the casing. Damaged or broken casing may affect the waterproof guarantee on the unit. After confirming that there is no damage to the casing, rinse the receiver/collar and clean out any dirt or debris.

Storage maintenance

The EDGE RT should be fully charged before storing for extended periods. While in storage, the unit should be given a full charge once a month, and before the first use. Store the units in room temperature. Do not keep the units exposed to extreme climates.

Troubleshooting

If the unit is malfunctioning, please refer to the “Troubleshooting Guide” before sending it to Dogtra for service. If you have any questions or concerns, you may email them to info@dogtra.com, or call customer service at 1-888-811-9111.

Troubleshooting Guide

1. My dog is not reacting to the collar.

- Make sure the receiver/collar is turned on. To turn on/off the receiver/collar, hold the red dot on the front of the transmitter to the red dot on the receiver/collar.
- Be sure the strap is on the dog tight enough so that both contact points are touching the dog's skin.
- The contact points may be too short for your dog's thick or long coat. To place an order for longer contact points, please contact Dogtra or a Dogtra dealer. If you are already using longer contact points, you may need to trim the hair on the dog's neck, so that both contact points are touching the dog's skin.
- The intensity level may be too low for your dog. Increase the stimulation until the dog responds, usually by a neck movement, head shaking, or looking over the shoulders. The response may be very subtle.

2. The LED indicator light comes on, but I do not feel any stimulation.

- Your tolerance may be higher than your dog's. You may need to try the unit on your fingertips where sensitivity is higher and/or increase the stimulation level. Be sure both contact points are touching both of your fingertips.
- The battery may be low, check the LED indicator light on the transmitter and receiver/collar for battery life.
- Make sure the receiver/collar is coded to the transmitter. To code the receiver/collar to the transmitter see section 10. Code setting.
- If you have a full charge, and you have done all of the above, your unit may need to be serviced. Please email us at info@dogtra.com, or call customer service at 1-888-811-9111.

3. The transmitter has no range, or the stimulation is weaker when my dog is farther away.

- Check to see if your fingers are touching the antenna, as the range may decrease substantially.
- The range indicated on the unit's box is for flat terrain (line of sight). Heavy brush, trees, hills, buildings, and/or moisture will affect the range of your unit. For the best range, hold the transmitter vertically above your head, and/or try moving to higher ground.
- Any electrical conductors will affect the range, such as cars, chain-link dog runs, metal buildings, and radio towers. For the best results, operate away from these structures.

4. My units are not holding a charge.

- The charging pin may be damaged. A metal pin inside the charging port should stand straight up and firm in the center. If the pin is wobbling, broken or missing, you will need to send the unit in to the repairs department.
- The charging port must be clean prior to charging, clean the dirt out with a cotton swab and some rubbing alcohol. If the dog was in salt-water, be sure to rinse the receiver and charging port with clean water.
- For Dogtra units over two years old from the purchase date, the batteries may need to be replaced. Dogtra strongly recommends sending the unit in for battery replacement and inspection. Damages incurred to the unit due to improper battery installations are not covered under the warranty.

5. My dog has skin irritation.

- This may be due to an improper fit. If your dog exhibits signs of skin irritation, consult with a veterinarian. Once the dog's skin returns to a normal condition, continue to use the collar and check your dog's neck each time you use the unit.

WARRANTY AND REPAIR INFORMATION

2-Year Limited Lifetime Warranty

Dogtra Company provides the original purchaser with a 2-YEAR WARRANTY for the 175NCP, 180NCP, 200NCP Gold Series, 210NCP Series, 280NCP Series, 300M Series, 1400NCP Series, 1500NCP Series, 1600NCP Series, 1700NCP Series, 1800NC Series, 1900NCP Series, 2000T&B Series, 2200NCP Series, 2300NCP Series, 2500T&B Series, 3500NCP Series, SureStim Series, ARC Series, and the EDGE RT. The warranty begins from the date of purchase. For the first two years, coverage is for both Parts and Labor on warranty repair services.

Accessories such as chargers, splitter cables, antennas, straps, and batteries are covered for the first year only. After the first two years, the Limited Lifetime Warranty covers Parts only and does not cover Labor Fees and Accessories. All Shipping fees incurred, the cost of Accessories after the first year, and Labor fees associated with out of warranty repair work, are the customer's responsibility. Labor fees will be variable depending on the extent of the work required. The Limited Lifetime Warranty expires 5 years after a model is discontinued from production by Dogtra.

To Qualify for the Dogtra Warranty

All products must be registered and/or a proof of purchase is required to initiate repair work under warranty. To register your Dogtra product, log onto our website at www.dogtra.com, click on the warranty registration link, and fill out the required information. Registration must be completed within 30 days of purchase. If you do not have access to a computer, you can call our toll free number at 1-888-811-9111, and one of our customer service representatives will register the product for you. If you were unable to register your product within 30 days of purchase, we will accept all products for repair with a proof of purchase. We strongly recommend keeping the original receipt. If your product is not registered and a proof of purchase is not available at the time of service, Dogtra will estimate the age of the unit by the serial number. Serial number estimates can differ from the actual purchase date. A serial number estimate is the only method of determining an approximate date of purchase without product registration or a proof of purchase.

Not Covered Under Warranty

Dogtra DOES NOT offer warranty for products that have been bought secondhand or as a resold product.

Dogtra DOES NOT replace defective units or provide refunds for products purchased from us after 30 days from the date of purchase.

Dogtra DOES NOT cover the cost of shipping outside of the Continental United States. Issues of replacement and refunds on units purchased less than 30 days from an authorized dealer must be addressed to the dealer directly. If the products purchased from an authorized dealer are after 30 days from the date of purchase, please send the units to Dogtra for service and repair.

Dogtra DOES NOT cover the cost of repairs and replacements due to misuse by the owner or dog, improper maintenance, and/or lost units. Any water damage on the Water Resistant Transmitters of the 175NCP, 180NCP, 200NCP Series, 1400NCP Series, 1500NCP Series, and iQ Pet Series, and the Water Resistant Receivers of the RRS, RRD, and RR Deluxe, will not be covered. All replacement costs for either the transmitter or receiver will be the owner's responsibility.

The warranty is void if the unit has been altered or an unauthorized person has damaged the unit while attempting repair work.

Battery replacement by the customer during the first year of the 2-year Limited Lifetime Warranty is not recommended. If the customer chooses to replace the batteries, any damage to the unit during the change-out by the owner will void the warranty.

The removal of serial numbers from any Dogtra products will void the warranty.

Dogtra reserves the right to retain and discard any parts or accessories that have been found damaged upon replacement and repair.

Procedure for Repair Work

If the unit is malfunctioning, please refer to the "Troubleshooting Guide" in the Owner's Manual and call customer service at 1-888-811-9111, for technical support, before sending it to Dogtra for Service.

The cost of shipping products under warranty back to Dogtra is the customer's responsibility. Dogtra is not responsible for units damaged or lost in transition to Dogtra. Dogtra is not responsible for loss of training time or inconvenience while the unit is in for repair work. Dogtra does not provide loaner units or any form of compensation during the repair period.

A copy of the sales receipt showing the purchase date may be required before warranty work is initiated.

Please include a brief explanation outlining the problem and include your name, address, city/state/zip code, daytime phone number, evening phone number, and email address. Or you can visit our website at www.dogtra.com for a service request form. If the repair costs are not covered under warranty, we will call you for payment information and authorization. For any questions concerning your Dogtra products, call us toll free at 1-888-811-9111, M-F 8:30AM - 4:00PM, Pacific Standard Time, or email us at repair@dogtra.com for specific repair inquiries.

Send repair units to :
Dogtra Company / Repairs
22912 Lockness Avenue
Torrance, CA 90501
U.S.A.

The diagrams and representations in the manual may differ slightly from the actual product depending on the model type.