

SecurityMan®

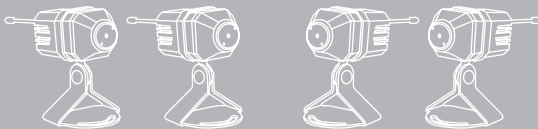
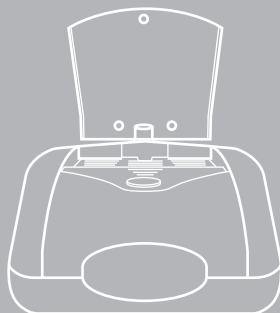

Mini-AirWatch4

Four 2.4GHz Wireless Color Camera Kit User Guide

Copyright Notice

This manual is furnished under license and may be used or copied only in accordance with the terms of such license. Except as permitted by such license, no part of this publication may be reproduced, stored in a retrieval system, or transmitted, in any form or any means, electronic, mechanical, recording, or otherwise, including translation to another language or format, without the prior written permission of SecurityMan.

The content of this manual is furnished for informational use only, is subject to change without notice, and should not be construed as a commitment by SecurityMan. SecurityMan assumes no responsibility or liability for any errors or inaccuracies that may appear in this book.

All other product names, trademarks and registered trademarks in this document are the properties of their respective holders.

FCC Information

Notes on FCC's "Consistent Statement of Information" This product meet the requirements specified in Part 15 of FCC Regulation. Operation rests with the following two conditions:

- (1) The equipment should not cause any harmful interference.
- (2) The equipment must receive and process any interference, including any possible interference caused by operation mistakes.

After testing the product, we confirm that the camera complies with the provision for class C digital equipment in the 15th part in FCC regulations; and the receiver complies with the limitations for class B digital equipment in Part 15 of FCC regulation. The product generates, applies and emits radio waves. It might cause harmful interferences to wireless communication if not be installed and used following the description of the manual.

The product may cause interference in residential area, and the customer should take remedies to eliminate the interference on their own costs.

If the product causes any harmful interference to wireless equipment or disturbs the receiving of TV signals (it can be identified by turning on and off the product), you can solve the trouble by following methods:

- Readjust the product or put it in another place.
- Extend the distance between the equipment interfered and the product.
- Refer to dealers or experienced radio electrician for help.

Warranty

SecurityMan warrants that this product will be free from defects in materials and workmanship for period of time specified on the product packaging. This limited warranty shall commence from the date of purchase. SecurityMan Products warranty is not transferable and is limited to the original purchaser. If the product is found to be defective then, as your sole remedy and as the manufacturer's only obligation, SecurityMan will repair or replace the product. This warranty shall not apply to products that have been subjected to abuse, misuse, abnormal electrical or environmental conditions, normal wear and tear or any condition other than what can be considered normal use.

Limitation of Liability

The liability of SecurityMan arising from this warranty and sale shall be limited to a refund of the purchase price. In no event shall SecurityMan be liable for costs of procurement of substitute products or services, or for any lost profits, or for any consequential, incidental, direct or indirect damages, however caused and on any theory of liability, arising from this warranty and sale. These limitations shall apply not with standing any failure of essential purpose of any limited remedy.

SecurityMan

15861 Tapia Street, Irwindale, CA 91706, USA

Tel: 888-977-3777 Fax: 626-338-3585

Email: info@securitymaninc.com

Website: <http://www.securitymaninc.com>

Notice:

2.4Ghz wireless camera works at ISM band. It may cause interferences with other wireless equipment that operates at the same band. Please turn off one of the equipment to eliminate the interference.

Product Assurance

2.4Ghz wireless camera will emit electromagnetic wave, just like other wireless products. But the output power of the products is lesser than other wireless products such as mobile phones. The 2.4Ghz wireless camera meets wireless frequency security standards and recommend indexes while working. These standards and indexes are certificated by academic organization and represent the cogitative research of the scientific workers who continuously explore and annotate the involved fields. So we believe that our products are safe for customers.

Operating Restrictions

DO NOT use this product to violate one's privacy. Monitoring one's activities without consent is illegal and this product is not designed and manufactured for these purposes.

DO NOT put this product near any medical equipment. Radio waves might potentially cause breakdown of electrical medical equipment. This product should be placed at least 1 feet away from any heart pacemaker. Radio waves might potentially influence heart pacemaker and lead to respiratory disturbance.

DO NOT use this product for any illegal activities. SecurityMan shall not be responsible for any consequences of illegal conducts by users.

Conditions

Please read the following messages to make sure whether your working environment is suitable.

- Ensure there is enough space around the receiver for ventilation.
- The temperature should be kept between -20°C and 50°C ($-4\text{F} - 122^{\circ}\text{F}$). The relative humidity should remain from 20% to 80%.
- Avoid putting the product in places where occur might change rapidly in temperature or humidity
- Keep it dry, dustless and avoid exposure in it directly in sunlight
- Keep product away from heat sources such as electric heater
- Do not use the camera near aggressive chemicals
- Do not place product near any magnetic objects

Maintenance

It might influence the normal operation of the product if used at the fringe range of normal temperature. Please turn off the power when not in use

Do not disassemble the product.

Do not shake or stricken the product.

Do not use this camera near water- for example, near a bath tub, wash bowl, kitchen sink or laundry tub, in a wet basement or near a swimming pool; and the like.

Please obey the local government's environment protection policy

Warning:

- In order to avoid inflammation or electric shock, this machine should be kept away from exposure to rain or moist, and it shall not be put in or near bathrooms, washing pools, washhouses, moist basements, or swimming pools.
- In use of sockets set on walls or extension wires, attention should be paid not to exceed their load capabilities to avoid inflammation or electric shock;
- Casings are not allowed to open, otherwise the internal precision parts may get damaged, or personal injury caused.
- Switch off the power supply in thunder and lightning or when not in use for long periods of time.
- Do not attempt to service the product yourself as opening or removing covers may expose you to dangerous voltage or other hazards. Refer all servicing to qualified service personnel.

Important Information

The user's manual provides important information for customers to use their products properly, and avoid possible injuries and damages.



The condition of being susceptible to harm or injury



A careful attention to the probable effects of an act, in order that failure or harm may be avoided



A notification or communication of a fact, claim, demand, or proceeding



Information about a particular subject



Something that should not be done



DO NOT put the package plastic bags in reach of children or babies.

*It might cause asphyxia if children or babies putting the bags into their mouths.



DO NOT plug the AC adapter into the outlet in improper situation.

*Plugging AC adapter with wet hand might cause electric shock. Plugging AC adapter unsteadily might cause fire or electric shock.



DO NOT cover the AC adapter when it is connected to power socket, place the adapter near heaters, and put it on the floor that is equipped with a heater.

*The above-mentioned operation might cause fire or incidents.



DO NOT use it on airplanes. Please abide by the airways provision.

*It might influence the communication aboard and the flying apparatus if departing from the airways regulation. This will result in accident, possible death and severe physical hurt.



DO NOT put the camera in the wet place where water might splash or where rain-water and mist might erode.

*This place might cause fire, shock, short circuit, etc.



DO NOT disassemble or repair the camera, the receiver and other relevant peripheral equipment.

*Improper disassembly might cause damages to the product or the peripheral equipment.



DO NOT use the receiver on the surface of thermo labile material.

*Please embed thermal insulating material when using on the surface of the thermo labile material.

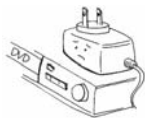

DO NOT place or use the AC adapter on temperature sensitive materials.

*The above practice might cause the plastic distortion, fading or sticking on the surface.



DO NOT touch, shake or hold the aerial.

*Touching, shaking or holding the aerial might influence the receiving of electromagnetic wave, and thereby influence the receiving effect.



DO NOT use several cameras with neighboring frequency closely at the same time

*The electromagnetic wave signal of the neighboring frequency might cause slight interferences and influence the receiving effect.



DO NOT let several cameras with same frequency work at the same time.

*The overlap of the electromagnetic wave signal of the same frequency might cause severe interferences and unable to receive signals.



Please adjust the brightness on TV or on monitor to achieve optimum efficiency.

*There are slight differences of brightness among cameras which can be adjusted



DO NOT use the camera in complex environment. The obstruction of stumbling block will affect the electromagnetic wave and influence the receiving range.

*Wall, tree and other stumbling block might absorb, reflect the electromagnetic wave and influence the receiving range.



DO NOT use the camera in the places that are covered by metal.

*Places surrounded by metal, such as elevator and cabinet, might shield the electromagnetic wave resulting in signal lost.



DO NOT Expose the Li-battery to heat, and avoid impact

*The above-mentioned operation will cause explosion

Contents

Introduction	9
Package Contents	9
Technical Support	9
Product Basics	10
Setting up the Camera(s)	11
Setting up the Receiver with TV/Monitor	13
Installation Diagram	14
Antenna Adjustment	14
Using Channel Switch on the Receiver	15
Using the Remote Control	15
Remote Control buttons and functions	16
Specification	17
Troubleshooting	19

Introduction

Thank you for purchasing Mini-AirWatch Wireless Camera Kit. It consists of 4 Color Video Cameras with built-in 2.4GHz Video Transmitter, and a Video Receiver unit which you connect to a TV anywhere in your home (up to 100ft. away from the camera). The Camera converts the video and audio signals into radio signals and transmits them to the Video Receiver. The Receiver converts the signals back to video and audio signals which are fed through a cable to your TV's or VCR's A/V input jacks.

Note: Please read the manual entirely before using the product.

Package contents:

- 4 x Wireless AV Camera (ZT-809T)
- 1 x Remote Wireless AV Receiver (ZT-705)
- 1 x IR Remote Controller
- 1 x AV Cable
- 4 x 8V power adapter for Camera
- 1 x 12V power adapter for Receiver
- 4 x Focus Adjustment Tool
- 4 x Brackets
- 4 x 9V Batteries

Technical Support

In U.S.A, please call 1-626-214-2770 or in other areas,
E-mail us at: techsupport@securitymaninc.com

Product Basics

Camera

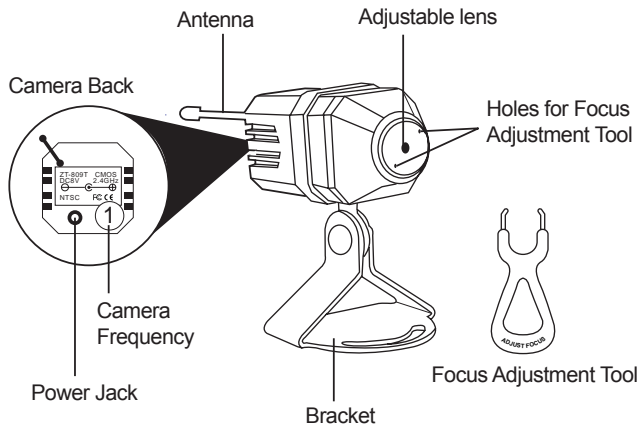

Remote Control

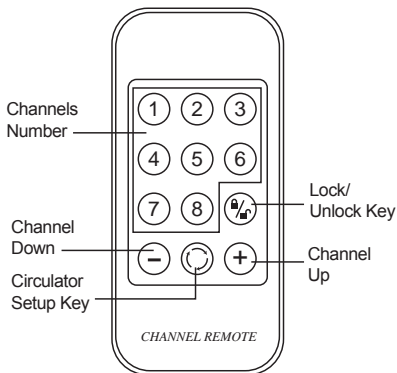

Receiver Back

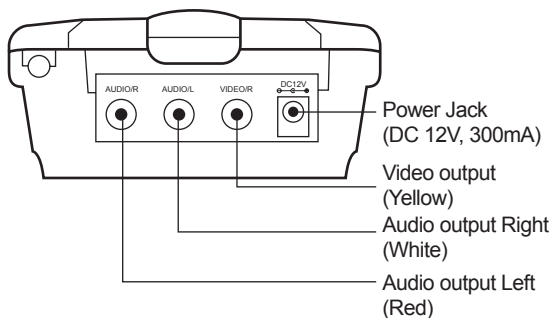

Receiver Front

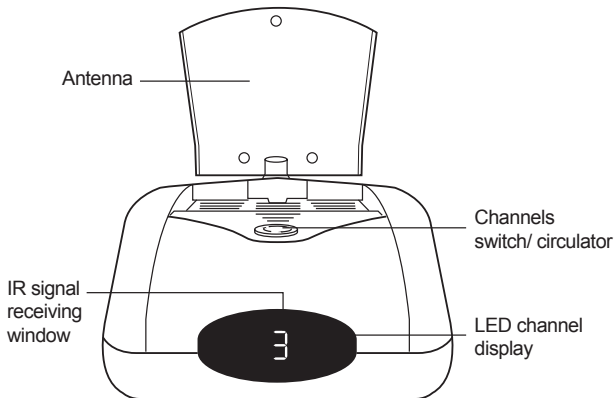

Battery Clip

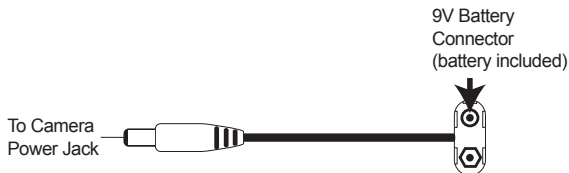

Setting up the Camera(s)

- 1) Place the camera(s) at desired location.
- 2) Plug the power adapter or battery clip jack into the power jack at the back of the camera.
- 3) Plug the power adapter to any AC outlet or plug a 9V battery to the battery clip.
- 4) Check the Camera Frequency number of each camera at the back. (The receiver will receive signal from camera's corresponding frequency and display in different channels. For example, Channel 1 on the TV/Monitor will display the picture from Camera 1 only).

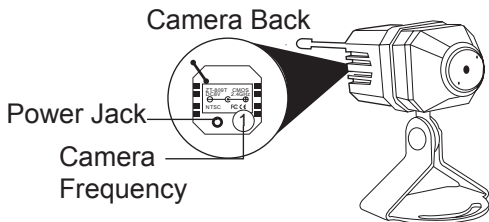

Setting up the Receiver with TV/Monitor

- 1) Connect one end of the A/V cable to the A/V out jacks of the Receiver. Connect the other end to your TV/Monitor A/V input.
- 2) Plug the Receiver's Power Supply (12V DC Adapter) into any wall outlet and plug its jack into the Receiver.
- 3) Place the Receiver in a convenient location such as top of a TV, and adjust the antenna.

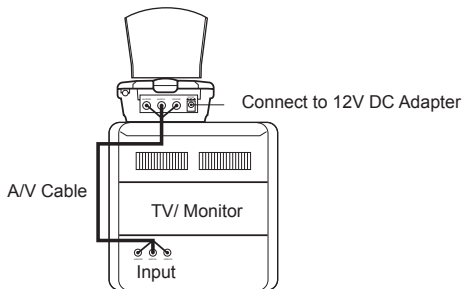

Installation Diagram

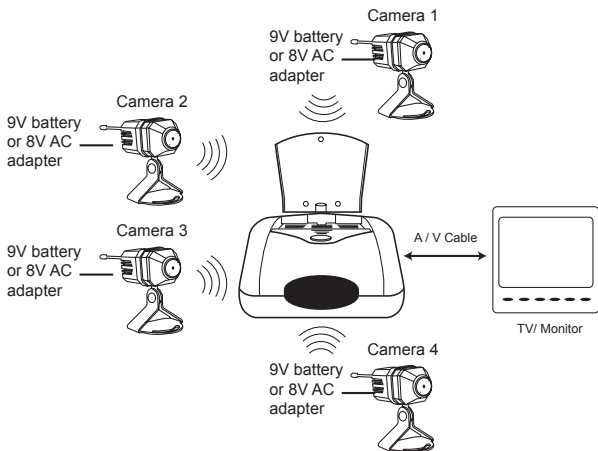

WARNING: When using power adapter, make sure the voltage indications on the adapters are compatible to the devices to avoid potential damages for incorrect usage of power.

Antenna Adjustment

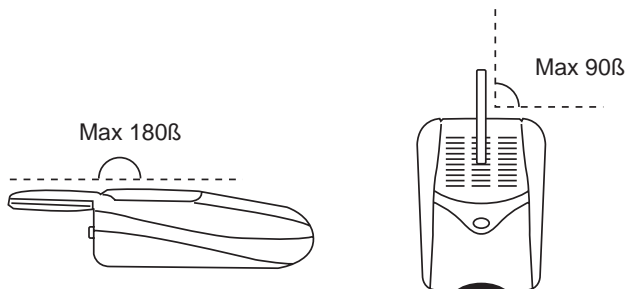

Using Channel Switch on the Receiver

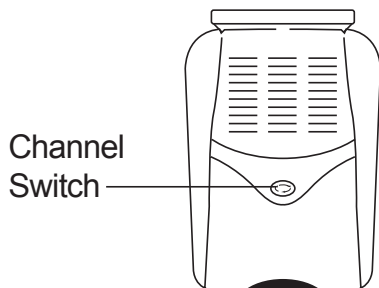

- 1) Press the Channel Switch **ONCE**, to change the channel corresponding to camera. You can view one camera at a time.

Ch1 > Ch2 > Ch3 > Ch4

(Press Channel Switch button once, it will change from Ch1 to Ch2 on the TV/Monitor, press again to Ch3 etc)

- 2) Press the Channel Switch **TWICE**, it will loop from Ch4 to Ch1 continuously.

Ch1 > Ch2 > Ch3 > Ch4



Using the Remote Control







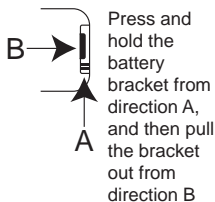









Note: Please remove the plastic from the battery compartment before using the IR remote control.





To reinstall the battery



Remote Control buttons and functions

Function	Button	LCD Indicator on Receiver
Channel Mode	 ~ 	Display the input channel
Channel Mode	 or 	Display the previous or next channel
Circulation Mode	 	When  is pressed once, it will display a blinking "L". Press the  again, it will display circulator setup running "  ".
Selective Circulation Mode	  ~  	When  is pressed once, it will display a blinking "L". Select the channel sequence you want to input and the number will display and it will blink on the LCD indicator, repeat until you are set. Press the  again, it will display circulator setup running "  ".
Enable/ Disable Mode		"d" means the remote controller function is disabled. "E" means the remote controller function is enabled.

For example, you want to set channel sequence display on the TV/ Monitor as Ch2 > Ch3 > Ch1 > Ch4. First press the  once and "L" will blink on the LCD display. Now input "2" from the remote, the number "2" will show on the LCD, continue to input "3" > "1" > "4" and press  again. The LCD will display circulator setup running "". And now the TV/Monitor will show the channel sequence as Ch2 > Ch3 > Ch1 > Ch4.

Specification

Specifications of Camera (ZT-809T)

Image Sensor	1/3-inch CMOS
CMOS Total Pixels	628 X 582 PAL 510 X 492 (NTSC)
Horizontal Resolution	380 TV Lines
View Angle	60°
Minimum Illumination	1.5Lux/F1.5
Video Gain Control	Automatic
Frequency	ISM 2400~2483 MHz 4CH
Focus	Adjustable
Transmission Power	2mW
Modulation Mode	FM
Bandwidth	18MHz
Microphone	Built-in
Power Supply	+8V DC
Consumption Current	80mA(Max)
Operation Temperature	-20°C~50°C / -4°F~122°F
Storage Temperature	-40°C~85°C / -40°F~185°F
Operation Humidity	85%
Dimensions (W x L x H)	1.61" x 0.94" x 0.94"
Weight	20g
Mounting Bracket	Up/Down/Left/Right Adjustable







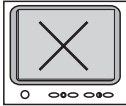

Specifications of Receiver (ZT-705)

Receiving Frequency	ISM 2,400~2,430 CH4*
Receiving Sensitivity	-85 dBm
Video format	NTSC / PAL
Power Supply	+12V DV
Power Consumption Current	250mA
Operating Temperature	-10°C ~ 55°C / 14°F ~ 122°F
Storage Temperature	-40°C ~ 85°C / -40°F ~ 185°F
Operating Humidity	85%
Dimensions (WxLxH)	6.1" x 4.3" x 2"
Weight	240g

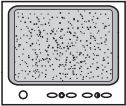
*2,400 – 2,483Mhz frequency range: CH1 = 2,414Mhz
CH2 = 2,432Mhz
CH3 = 2,450Mhz
CH4 = 2,468Mhz

Actual transmission range may vary according to weather, location, interference & building construction.

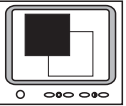
Troubleshooting

Abnormal Phenomena		Possible Reasons/Solutions
 No image	 No sound	*Check the camera / receiver connected to power supplies, and power on.
 Snowflakes on image	 Noisy	*Check if the channel of receiver is corresponding to camera; *Check the distance and blocks.
 Ghost image	 Normal sound	*Interfered by other sources; *Check the distance and blocks.
 No color	 Normal sound	*Mismatching system of PAL TV and NTSC cameras or vice versa.

www.securitymaninc.com