

BOSCH

**Use and Care Manual
For Household Use Only
Notice d'utilisation et d'entretien
Usage domestique uniquement
Manual de instrucciones y cuidado
Sólo para uso doméstico**

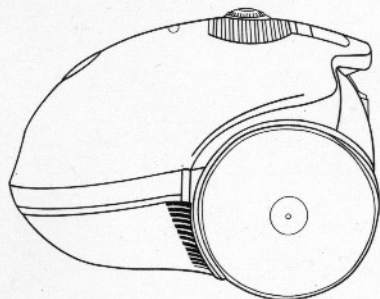

BSA2...UC Vacuum cleaner

Important Safeguards

Use as directed

⚠NOTE

This vacuum cleaner is intended for use in the home and not for industrial purposes.

The vacuum cleaner must be used exclusively in accordance with the specifications stated in the instructions.

The manufacturer shall not be held liable for any damages which arise from use which is not as directed or has been caused by an incorrect operation of the vacuum cleaner. Therefore, please ensure that the following information is observed and heeded.

Safety information

READ ALL INSTRUCTIONS BEFORE USING THIS APPLIANCE

⚠WARNING - To reduce the risk of fire, electric shock, or injury:

⚠CAUTION

- **Do not** leave appliance when plugged in. Unplug from outlet when not in use and before servicing.
- **Do not** use outdoors or on wet surfaces.
- **Do not** allow to be used as a toy. Close attention is necessary when used by or near children.
- **Do not** use with damaged cord or plug. If appliance is not working as it should, has been dropped, damaged, left outdoors, or dropped into water, return it to a service center.
- **Do not** pull or carry by cord, use cord as a handle, close a door on cord, or pull cord around sharp edges or corners. Do not run appliance over cord. Keep cord away from heated surfaces.
- **Do not** unplug by pulling on cord. To unplug, grasp the plug, not the cord.
- **Do not** handle plug or appliance with wet hands.
- **Do not** put any object into openings. Do not use with any opening blocked; keep free of dust, lint, hair and anything that may reduce air flow.
- **Do not** use to pick up flammable or combustible liquids, such as gasoline, or use in areas where they may be present.
- **Do not** pick up anything that is burning or smoking, such as cigarettes, matches, or hot ashes.
- **Do not** use without dust bag and/or filters in place.
- **Do not** vacuum up damp substances or liquids to avoid electrical shock hazards.
- **Do not** operate the brush on or next to people or animals or let the tube or nozzles get close to your face or head to prevent entanglement or possible injury from flying debris.
- **Do not** operate the vacuum if any part of it is damaged to prevent injury to the operator or bystanders.

- **Do not** use machine as a step.
- **Do not** re-use or wash the filters.
- **Do not** remove any screws.
- **Do not** vaccum up sharp objects to prevent injuries when opening or emptying the appliance.
- **Do not** use a damaged vaccum appliance.

- **Do** operate the appliance only with original dust bags.
- **Do** operate the appliance only by using original spare parts, accessories or optional accessories. Use only as described in this manual.
- **Do** connect and start up the vacuum cleaner only in accordance with the information stipulated on the identification plate.
- **Do** protect the vacuum cleaner from external weather conditions, dampness and heat sources.
- **Do** switch off and unplug the appliance before any assembly, cleaning and before servicing.
- **Do** supervise children whenever they are around an operating appliance to prevent injury to the child and possible damage from misuse of the appliance.
- **Do** switch off and unplug the appliance if it stops sucking or at the event of any other fault.
- Keep hair, loose clothing, fingers, and all parts of body away from openings and moving parts.
- Turn of all controls before unplugging.
- Use extra care when cleaning on stairs.
- Hold plug when rewinding onto cord reel. Do not allow plug to whip when rewinding.
- Unplug before connecting the Turbo Universal floor brush.
- Use only as described in this manual. Use only manufacturer's recommended attachments.
- To reduce the risk of electric shock, this appliance has a polarized plug (one blade is wider than the other). This plug will fit in a polarized outlet only one way. If the plug does not fit fully in the outlet, reverse the plug. If it still does not fit, contact a qualified electrician to install the proper outlet. Do not change the plug in any way.

SAVE THESE INSTRUCTIONS!

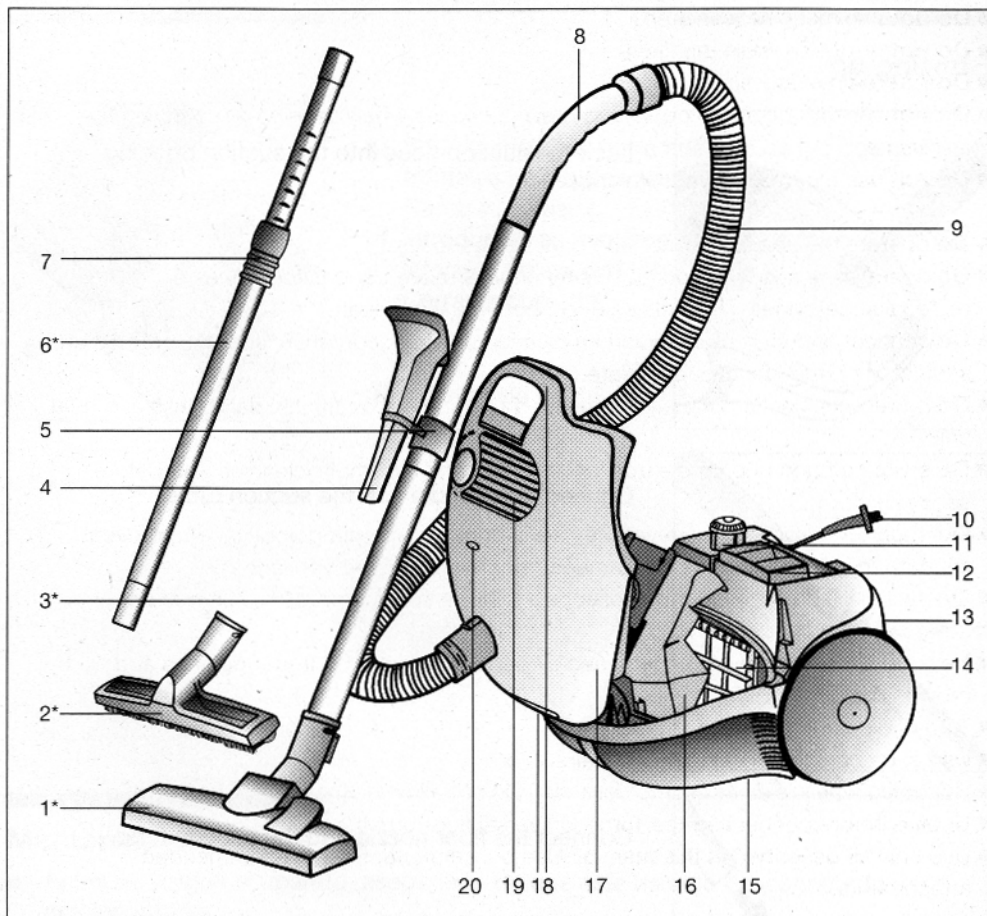

- | | |
|---|----------------------------|
| 1 Adjustable floor nozzle* | 12 Exhaust filter |
| 2 Hard floor nozzle* | 13 Parking aid |
| 3 2-parts steel tube* | 14 Microsan filter |
| 4 Combination nozzle | 15 Storing aid |
| 5 Attachment support for the
combination nozzle | 16 Dust bag |
| 6 Telescopic tube* | 17 Lid |
| 7 Sliding sleeve | 18 Handle |
| 8 Hose grip | 19 Exhaust grid |
| 9 Suction hose | 20 Dust bag change display |
| 10 Plug | |
| 11 On / off switch with
electronic suction regulator | |

*Depending on version

Starting up

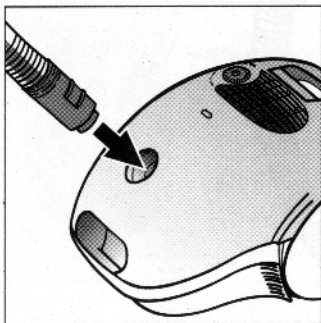

Lock the suction hose into the suction opening

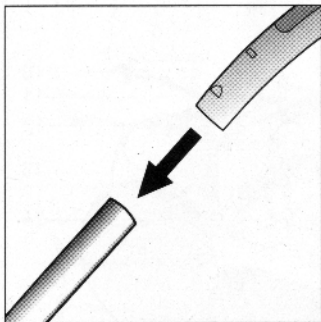

Connect the handle and the suction tube.

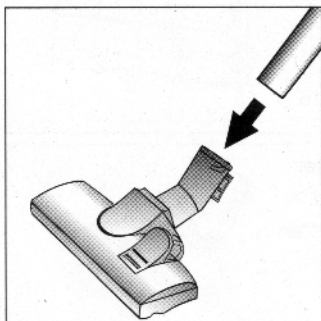

Connect the floor nozzle and the suction tube.

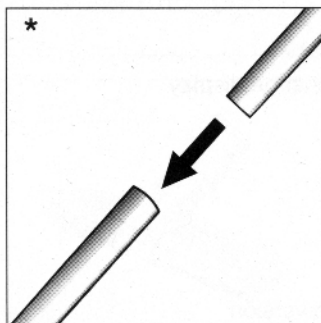

Connect the 2-part steel tube

*Depending on version

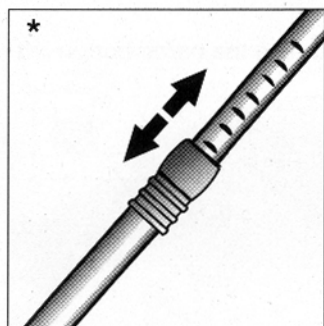

Unlock the telescopic tube and adjust to the desired length by moving the adjusting button/sliding sleeve up or down.

*Depending on version

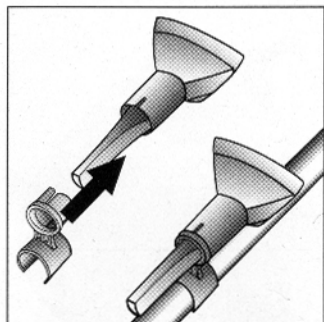

Slide the attachment support on to the combination nozzle and clip on to the suction / telescopic pipe

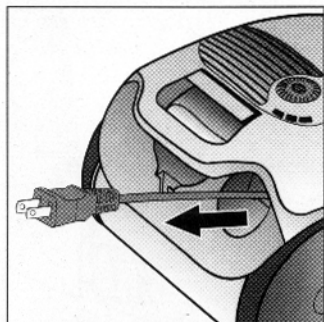

Take the cord by the plug and pull out the desired length and then plug into the socket.

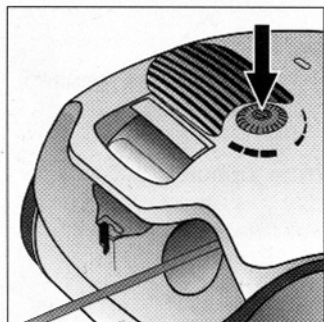

Switch on/off the vacuum cleaner by pressing the on/off button with your hand or your foot

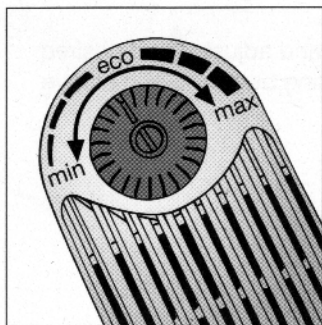

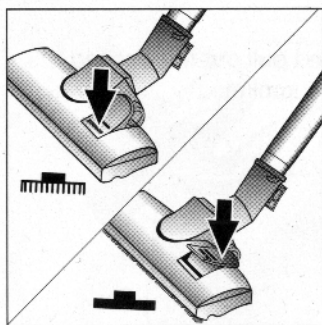

Set the level of suction by turning the on/off button left or right.

Suction



Adjusting the floor nozzle:

- For cleaning rugs and carpet => 
- For cleaning hard floors => 

This enables an optimum cleaning effect for the different flooring.

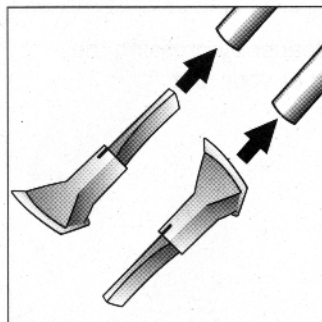

Vacuuming with accessories

(connect to the handle or the suction tube as required)

Combination nozzle

For vacuuming in corners, joints, upholstery, curtains etc.

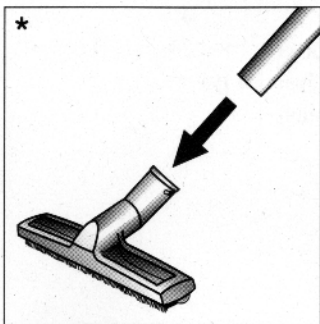

Hard floor nozzle
For vacuuming hard floor surfaces (tile, wood etc)

*Depending on version

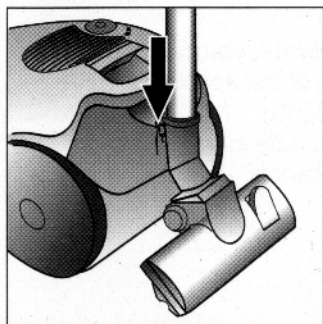

When taking brief vacuuming pauses, you can use the parking aid on the back of the appliance. Push the hook on the floor nozzle in to the recess on the back of the appliance.

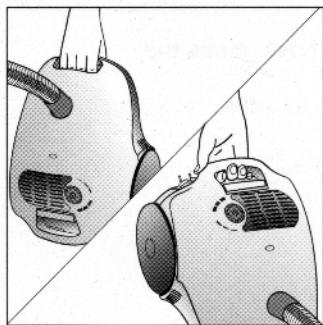

The appliance can be carried using the two grips. This is especially useful when vacuuming stairs or reaching up to the ceiling.

After use

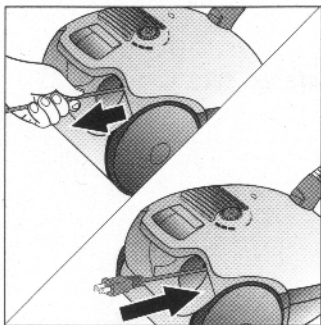

Pull out the plug from the socket.
Pull briefly on the cord and then let go
(the cord rolls up automatically)

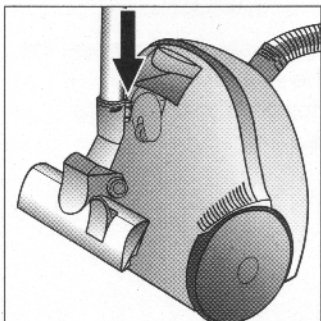

To store / transport the appliance, you can use the
storing aid on the underside of the appliance.
Stand the appliance up straight.
Push the hook on the floor nozzle in to the recess
on the underside of the appliance.

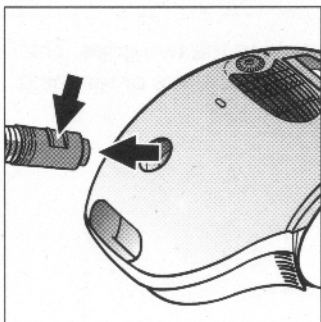

When removing the suction hose, press the
latch and pull out the hose.

Changing the filter

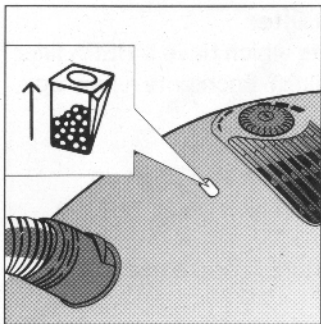

Replace the dust bag

The dust bag change display on the lid turns yellow, when it's time to replace the bag.

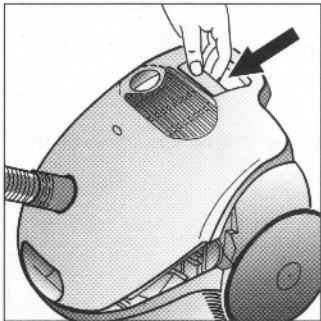

Open the covering by lifting up on the lever.

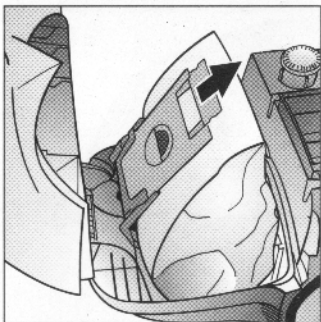

Seal and remove the dust bag by pulling on the cover clip

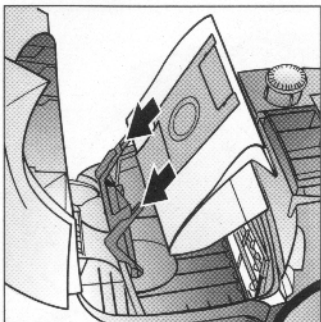

Insert the new dust bag in the holding fixture, up to the stop.

Attention: Cover will only close if a paper filter is inserted! After vacuuming fine dust particles (e.g. cement, plaster, etc.), clean the motor filter and replace the Microsan filter if necessary.

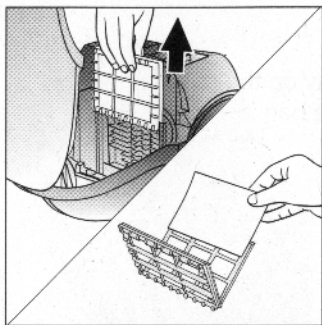

Replacing the Microsan filter

(Omitted on vacuum cleaners which have a HEPA filter.)

When should I change the filter? Each time a new box of dust bags is opened.

- Open the covering.
- Pull out the filter holding fixture and open up.
- Dispose of the old Microsan filter and insert the new one.
- Slide the filter holding fixture in and close the covering.

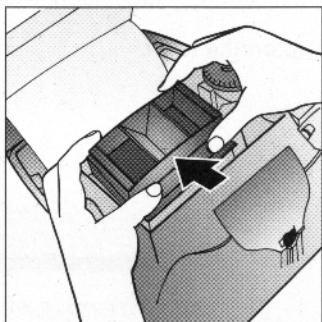

Cleaning the motor filter

- Open the covering.
- Unlock the insert by pressing in the direction of the arrow and pull out.

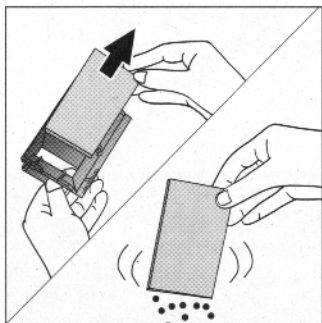

- Remove the motor filter and clean it.
- Insert the cleaned motor filter.

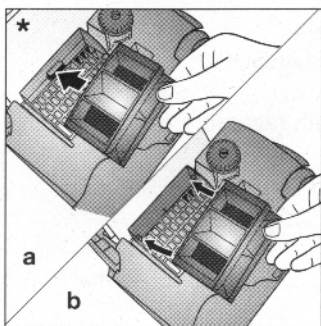

- a) Push in the insert below the front support ribs and engage.
Close the covering.
- b) Push in the insert below the two lateral support ribs and engage.
Close the covering.

*Depending on version

Maintenance

- Before the appliance is cleaned, ensure that it has been switched off and unplugged.
- Vacuum cleaners and accessories made of plastic can be cleaned using a general commercial plastic cleaner.

**Do not use scouring agents, glass or all-purpose cleaners.
Never immerse the vacuum cleaner in water!**

- If necessary, the dust compartment can be cleaned using another vacuum cleaner, or simply cleaned with a dry dust cloth / dust brush.

Spare parts and optional extras

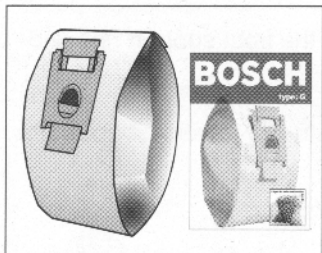

Dust bag MEGAfil® BBZ51AFGUC

Contents:

5 x dust bags MEGAfil® with fasteners and
1 Microsan filter

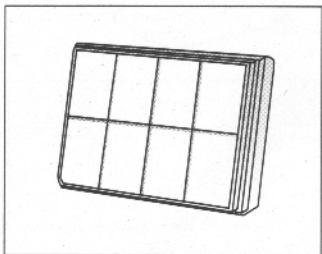

HEPA Filter BBZ8SF1UC

additional filter for pure exhaust air.
Recommended for those with allergies.
Replace every year.

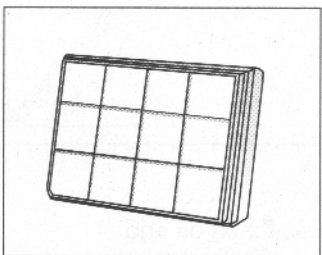

Micro-/Activated Charcoal filter BBZ8KF1UC

Combination of micro filter and activated charcoal
filter.

The thick layer of activated charcoal prevents any
disturbing odors for a long period of time (replace
every 6 month).

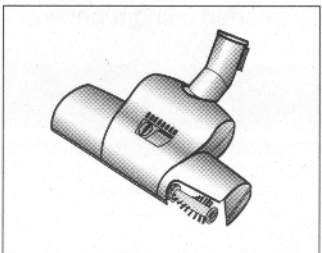

TURBO-UNIVERSAL-floor brush BBZ28TBUC

Suitable for all floors. Brushes and vacuums in one
step. Flattened piles are restored.

No marks are left in the piles. Lifts fluff, threads and
hair with ease.

The brush roller is driven by the suction force of the
vacuum cleaner. No electrical connection required.

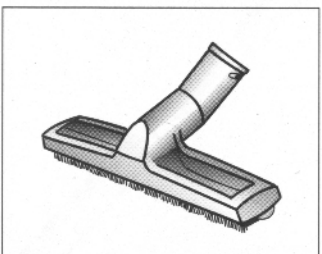

Hard floor nozzle BBZ120HDUC

With extra soft bristles for all delicate wooden or other
hard floors (tile, stone, etc.)